

(H) Sensor controller

PA10 Series(Multifunctional Sensor controller) ——— H-1

PA-12(General purpose Sensor controller) ——— H-8

Application ——— H-10

(A)
Counter

(B)
Timer

(C)
Temp.
controller

(D)
Power
controller

(E)
Panel
meter

(F)
Tacho/
Speed/
Pulse
meter

(G)
Display
unit

**(H)
Sensor
controller**

(I)
Switching
power
supply

(J)
Proximity
sensor

(K)
Photo
electric
sensor

(L)
Pressure
sensor

(M)
Rotary
encoder

(N)
Stepping
motor &
Driver &
Controller

(O)
Graphic
panel

(P)
Production
stoppage
models &
replacement

PA-12



PA10-U



PA10-V/ VP



PA10-W/ WP



PA10 Series

Multifunctional sensor controller

■ Features

- 12 kinds of various operation modes selected by DIP switches
- High speed input response
- Flip-flop function for level control
- Multifunctional unit with Timer mode
- DIN rail mounting and mountable without the rail
- Wide range of power supply (100–240VAC 50/60Hz)

⚠ Please read "Caution for your safety" in operation manual before using.



■ Ordering information

PA 10 — U

	NPN input
P	PNP input
U	High function controller
V	General purpose controller
W	2-channel controller
10	Multi-function
PA	Power Amplifier

■ Specifications

Model	PA10-U	PA10-V	PA10-VP	PA10-W	PA10-WP
Power supply	100–240VAC 50/60Hz				
Allowable operation voltage	90~110% of rated voltage				
Power consumption	100VAC 50/60Hz : Approx. 7VA (Conduction:12VDC/200mA resistive load), 240VAC 50/60Hz : Approx. 10VA				
Power for external sensor	12VDC ±10% max. 200mA				
Input(IN1)(IN2)	Selectable NORM/INV. Selectable OR/AND operation for IN1, IN2 input. Selection function for IN2 derivative action.	Selectable NORM/INV. Operation for IN1, IN2 AND.		Selectable NORM/INV. Selection function for IN1, IN2 individual operation.	
	NPN input type	NPN input type	PNP input type	NPN input type	PNP input type
Input type	●PA10-U [No-voltage input] Impedance at short-circuit:Max. 680Ω, Residual voltage at short-circuit:Max. 0.8V, Impedance at open:Min. 100kΩ ●PA10-V/PA10-W [No-voltage input] Impedance at short-circuit:Max. 300Ω, Residual voltage at short-circuit:Max. 2V, Impedance at open:Min. 100kΩ ●PA10-VP/PA10-WP [Voltage input] Input impedance:5.6kΩ, "H" level voltage:5–30VDC, "L" level voltage:0–2VDC				
Output	Contact output	OUT : 250VAC 3A(resistive load)		OUT1, OUT2 : 250VAC 3A(resistive load)	
	Solid-state output	O • C OUT1/O • C OUT2 : NPN open collector output Max. 30VDC 200mA	O • C OUT : NPN open collector output max. 30VDC 200mA		—————
Response time	Relay contact : Approx. 10ms, Transistor output : Max. 0.5μs (When it is encoder mode)				
Timer function	<ul style="list-style-type: none"> • ON-Delay • OFF-Delay • Flicker • Flicker One-shot • High-Speed Detection • Low-Speed Detection • One-Shot Delay Selectable(0.01~0.1/0.1~1/1~10/10~100 sec)	Have	—————		
	<ul style="list-style-type: none"> • NORMAL • FLIP-FLOP • ENCODER(Mode 9~11) 	None	—————		
Relay life cycle	Mechanical	Min. 10,000,000 times			
	Electrical	Min.100,000 times(250VAC 3A resistive load)			
Dielectric strength	2000VAC 50/60Hz for 1 minute				
Insulation resistance	Min. 100MΩ (at 500VDC mega)				
Ambient temperature	-10 ~ 55°C (at non-freezing status)				
Storage temperature	-25 ~ 60°C (at non-freezing status)				
Ambient humidity	35 ~ 85%RH				
Unit weight	Approx. 150g			Approx. 160g	

※If the load is connected over 200mA at the sensor output, it may cause malfunction.

Sensor Controller

Dimensions

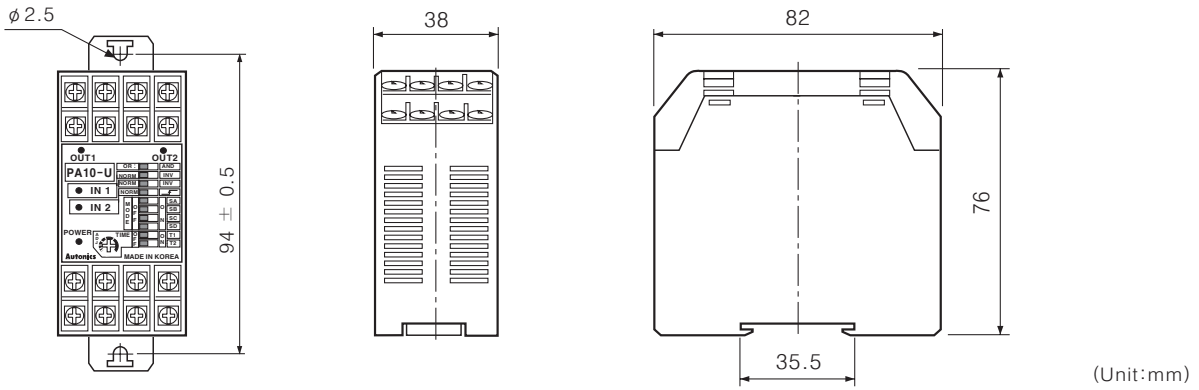

Connections

PA10-U

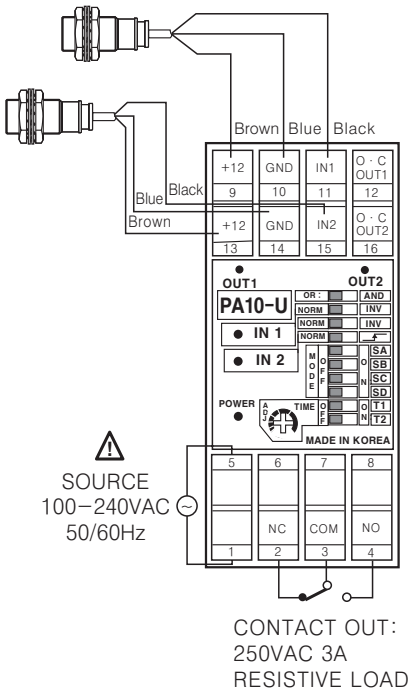

PA10-V/PA10-VP

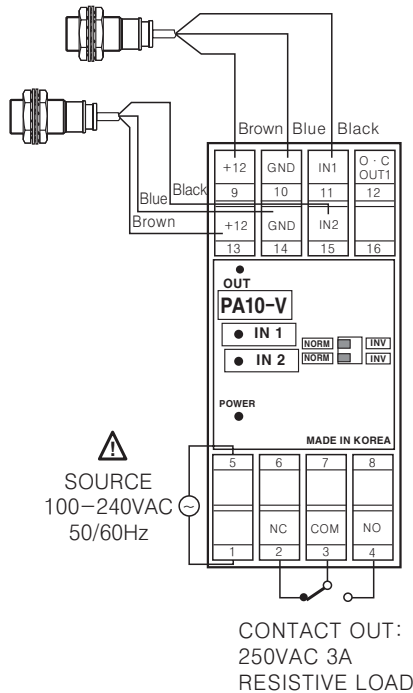

PA10-W/PA10-WP

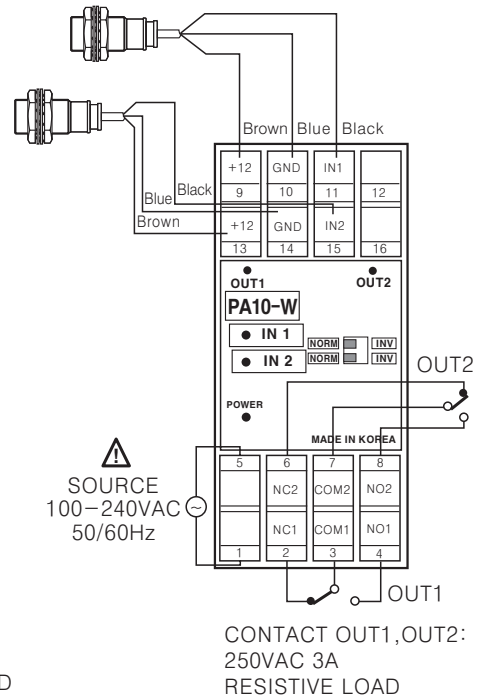

Input connctions

PA10-U / PA10-V / PA10-W

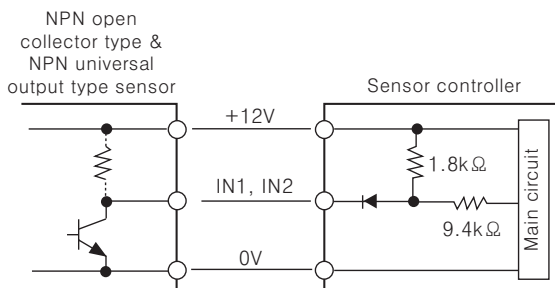

PA10-VP / PA10-WP

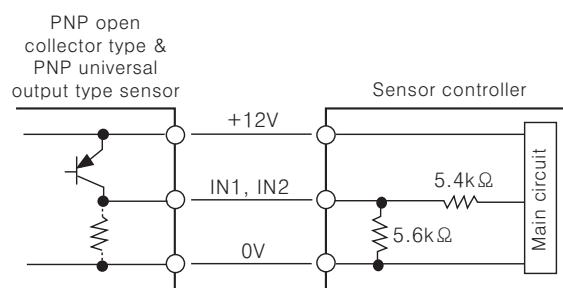

(A) Counter

(B) Timer

(C) Temp. controller

(D) Power controller

(E) Panel meter

(F) Tacho/Speed/Pulse meter

(G) Display unit

(H) Sensor controller

(I) Switching power supply

(J) Proximity sensor

(K) Photo electric sensor

(L) Pressure sensor

(M) Rotary encoder

(N) Stepping motor & Driver & Controller

(O) Graphic panel

(P) Production stoppage models & replacement

PA10 Series

Function diagram

PA10-U

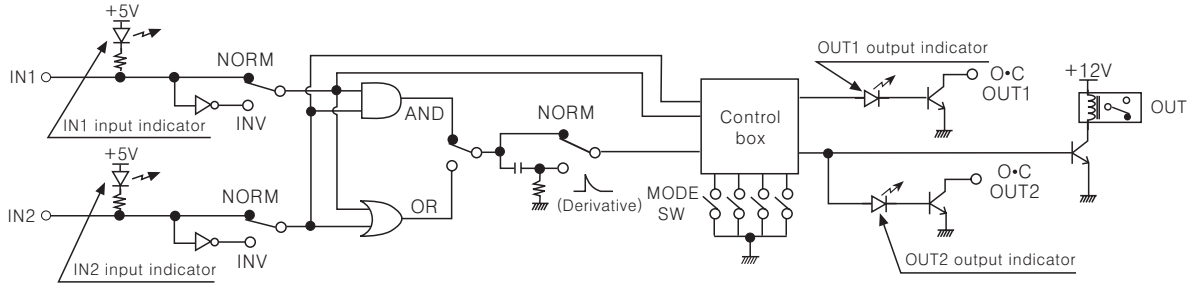

PA10-V PA10-VP

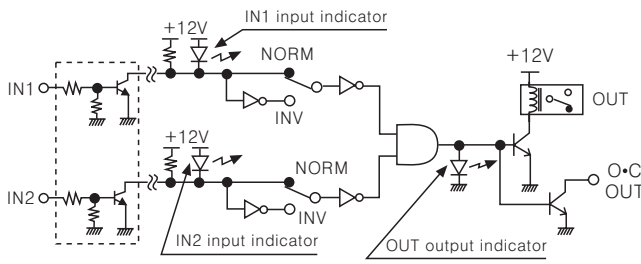

※Add when it is PNP input

PA10-W PA10-WP

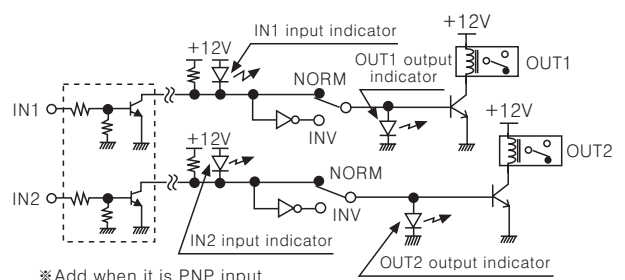

※Add when it is PNP input

Front panel identification

PA10-U

1 Power indicator :

LED is turned on when AC power applied

2 Output1 indicator :

Indicates output operation

3 Output2 indicator :

Indicates output operation

4 Sensor input indicator :

Indicates sensor input signal

(LED is turned on when sensor input is Low)

5 AND/OR selection switch :

Select "AND" or "OR" for IN1, IN2 Input

6 Selection switch of sensor input signal :

NORM **INV** (Reverse function of input signal)

●NORM : LED is turned on when input signal is low. (—)

●INV : LED is turned on when input signal is high. (—)

7 Derivative action selection of IN2 input signal (OR/AND selection switch : AND):

NORM (When input signal is high (—), it is effective signal)

●NORM : IN2 input signal is operating as reverse turn function

● : Derivative action of IN2 input signal. (※Refer to H-7, Application of derivative operation.)

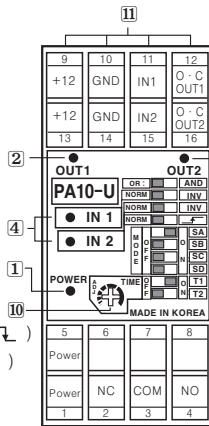

8 Selection switch for operation mode :

See <Operation mode> in next page.

9 Selection switch of time range and max. input frequency :

It is the switch to select time range (1~7 mode) or allowable input frequency(9~11 mode).



●Time range : Approx. 0.01 ~ 0.1sec.

Max. input frequency : 100kHz



●Time range : Approx. 0.1 ~ 1sec.

Max. input frequency : 10kHz



●Time range : Approx. 0.1 ~ 10sec.

Max. input frequency : 1kHz



●Time range : Approx. 10 ~ 100sec.

Max. input frequency : 100Hz

10 Timer adjuster :

Adjust time as same as the range of No. 9 function.

11 Terminal block

PA10-V/PA10-VP

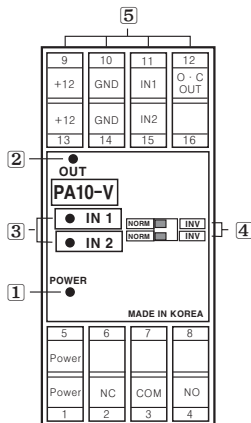

1 Power indicator :

LED is turned on when AC power applied

2 Output indicator :

Indicates output operation

3 Sensor input indicator :

●PA10-V : Indicates sensor input signal(LED turns on when sensor input is Low)

●PA10-VP : Indicates sensor input signal(LED turns on when sensor input is High)

4 Selection switch of sensor input signal

●NORM : LED is turned on when input signal is low.

●INV : LED is turned on when input signal is high.

5 Terminal block

※When IN1, IN2 input signal is AND, OUT will work.

PA10-W/PA10-WP

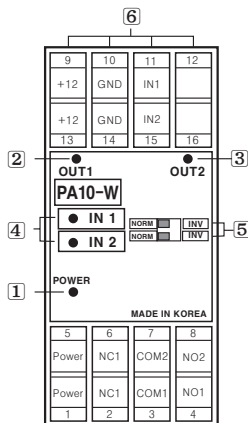

1 Power indicator :

LED is turned on when AC power applied

2 Output1 indicator :

Indicates output operation

3 Output2 indicator :

Indicates output operation

4 Sensor input indicator :

●PA10-W : Indicates sensor input signal(LED is turned on when sensor input is Low)

●PA10-WP : Indicates sensor input signal(LED is turned on when sensor input is High)

5 Selection switch of sensor input signal

●NORM : LED is turned on when input signal is low.

●INV : LED is turned on when input signal is high.

6 Terminal block

※Selectable NORM/INV.

Selection function for IN1, IN2 individual operation.

■ Operation mode(PA10-U)

● MODE 0 NORMAL MODE

OUT operates according to input signal, regardless of Timer.

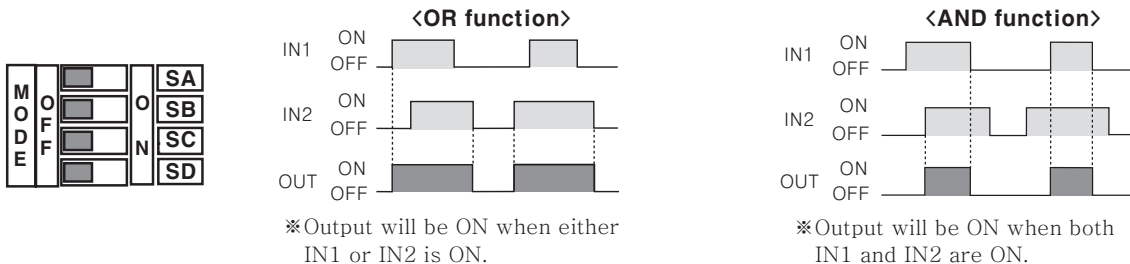

● MODE 1 ON-DELAY MODE

OUT will be ON after delayed as setting time according to one of IN1 and IN2 is ON.

When IN1 and IN2 are OFF, OUT will be OFF. (This is when input logic is OR.)

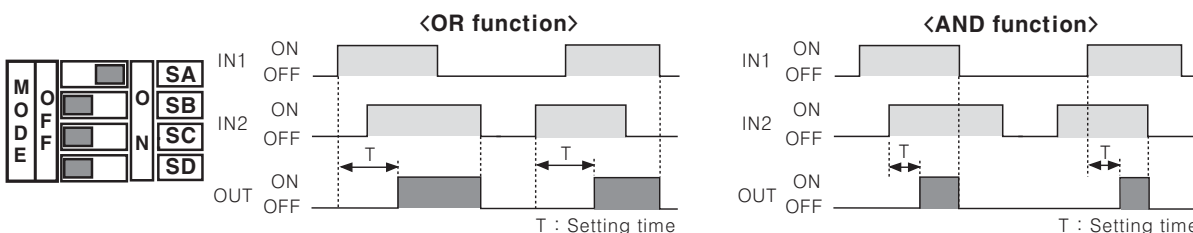

● MODE 2 OFF-DELAY MODE :

OUT will be ON at the same time when IN1 or IN2 is ON then OUT will be OFF after delayed as setting time according to IN1 or IN2 is OFF. (This is when input logic is OR.)

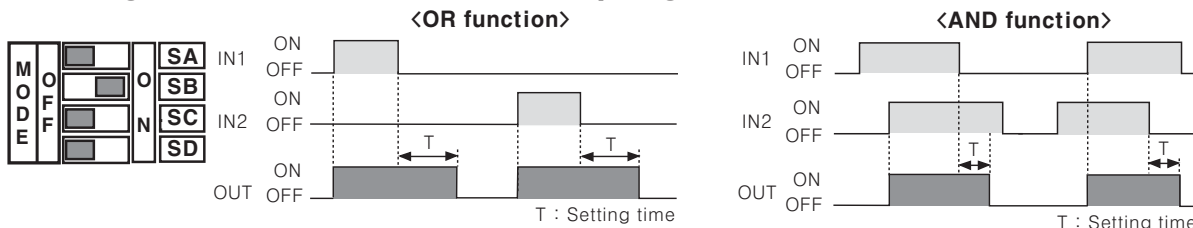

● MODE 3 ONE-SHOT DELAY MODE

OUT will be ON at the same time with IN1 or IN2 is ON then OUT will be OFF after delayed as setting time. (This is when input logic is OR.)

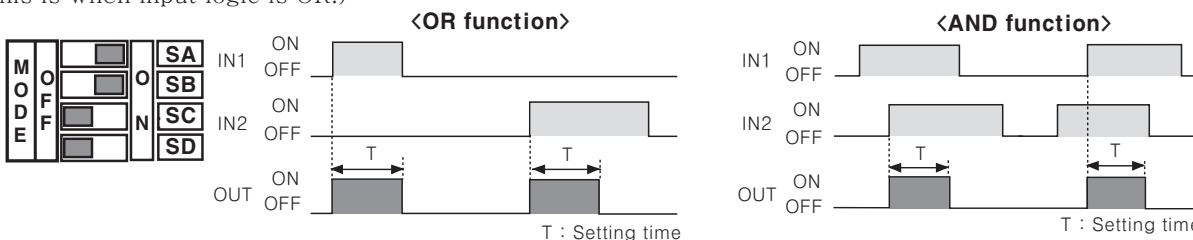

● MODE 4, 5 FLICKER MODE / FLICKER ONE-SHOT MODE

OUT will be ON after delayed as setting time for IN1 input then it is flashing and OUT will be flashing after setting time from ON. But, in case of One-shot Mode, output time(Ts) will be selected by NORM .

(: Ts = Approx. 10ms, NORM : Ts = Approx. 100ms)

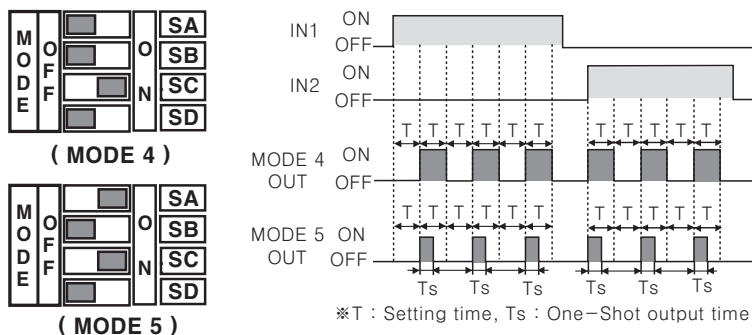

Note) ON/OFF ratio of Flicker output is 1:1.

Note) In case of Flicker Mode, it is not different between OR AND and NORM .

Note) In case of One-Shot Mode, it is not different between OR AND.

(A) Counter

(B) Timer

(C) Temp. controller

(D) Power controller

(E) Panel meter

(F) Tacho/Speed/Pulse meter

(G) Display unit

(H) Sensor controller

(I) Switching power supply

(J) Proximity sensor

(K) Photo electric sensor

(L) Pressure sensor

(M) Rotary encoder

(N) Stepping motor & Driver & Controller

(O) Graphic panel

(P) Production stoppage models & replacement

PA10 Series

■ Operation mode(PA10-U)

● MODE 6 LOW-SPEED DETECTION MODE

OUT will be ON when input signal(IN1) is longer than setting time by comparing it to the setting time by one cycle.

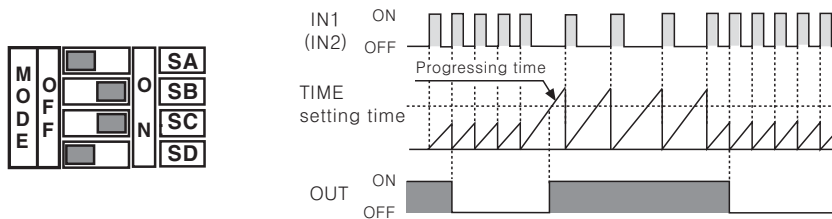

Note) Above is when input logic is OR and it will be the same by using IN2 input signal terminal instead of IN1.

Note) When use MODE 6 as above, be sure that OUT will be work at the same time with power supply.

● MODE 7 HIGH-SPEED DETECTION MODE

OUT will be ON when input signal(IN1) is shorter than setting time by comparing it to the setting time by one cycle.

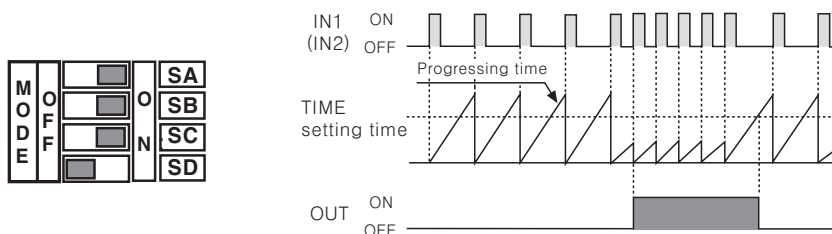

Note) Above is when input logic is OR and it will be the same by using IN2 input signal terminal instead of IN1.

◎ TIME Switches(MODE 1 ~ MODE 7)

Set the time by time switches(T1, T2) and front time adjuster(ADJ).

Mode TIME SWITCH Item	MODE 1 ~ MODE 7	MODE 6 ~ MODE 7
	Setting time range	Input frequency range (*rpm)
	0.01 ~ 0.1sec	100 ~ 10Hz (6,000 ~ 600rpm)
	0.1 ~ 1sec	10 ~ 1Hz (600 ~ 60rpm)
	1 ~ 10sec	1 ~ 0.1Hz (60 ~ 6rpm)
	10 ~ 100sec	0.1 ~ 0.01Hz (6 ~ 0.6rpm)

*Range of operating rpm is 1 pulse per 1 revolution.

*When the pulse is increasing per 1 revolution, range of operating rpm is decreasing.

● MODE 8 Flip-Flop MODE [OUT LATCH operation]

When IN1 signal is input then the Flip-Flop output will be ON(SET). When the IN2 signal is input, Flip-Flop Signal will be OFF(RESET).

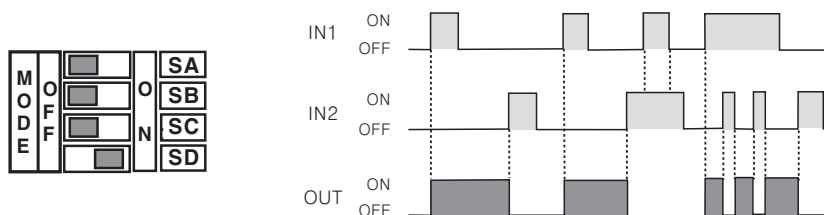

Note) IN2 will be prior to all input signal.

Note) Both OR AND and NORM switches are allowed to use.

Note) There is no Timer function in Flip-Flop Mode, therefore use this unit with time switches(T1, T2) are OFF.

■ Operation mode(PA10-U)

◎ ENCODER MODE(MODE 9 ~ MODE 11)

- 1) There should be 90° phase difference between IN1 and IN2 for input terminal.
- 2) Please connect A phase output of encoder to IN1 and B phase output of encoder to IN2, when use NPN open collector or totem pole output type of encoder with PA10-U. In this case, detection signal(O.C OUT2, OUT) output of PA10-U will be OFF when turning encoder to CW direction.
- 3) There are output function of pulse(O.C OUT1) has been multiplied(×1, ×2, ×4 times) against input signal and Direction detection output(O.C OUT2, OUT) function which detects direction of encoder revolution in Encoder mode.
- 4) Be cautious about input speed(cps) of connected equipment due to pulse width of O.C OUT1 is short.
- 5) OR AND NORM NORM INV Selection switches can be set at any position.

● MODE 9 ENCODER (Input pulse × 1time)

● MODE 10 ENCODER (Input pulse × 2times)

● MODE 11 ENCODER (Input pulse × 4times)

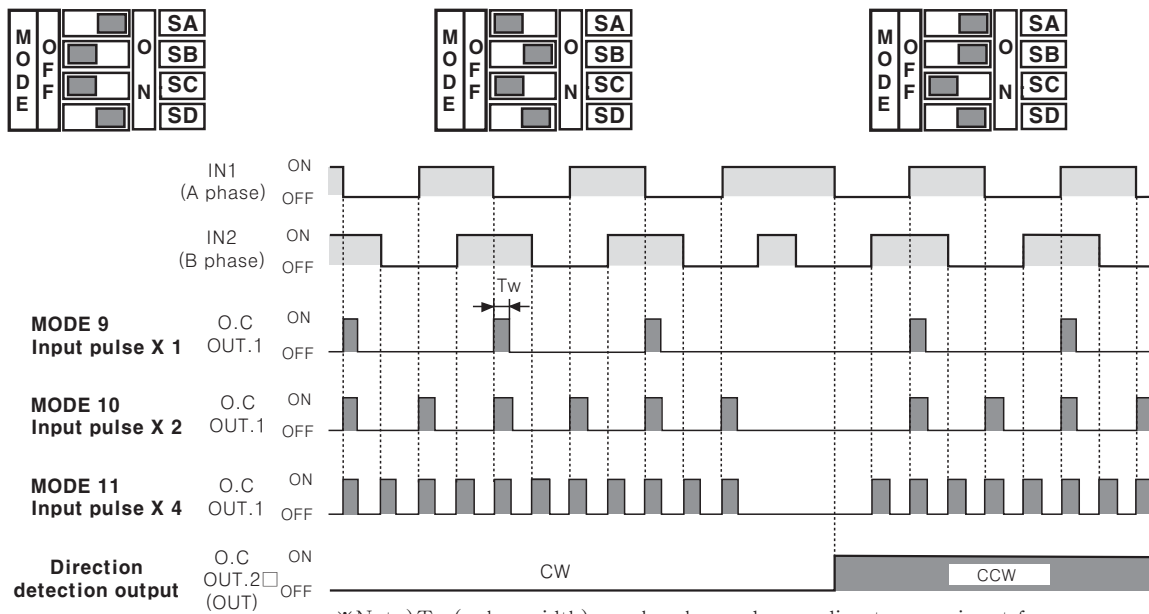

◎ TIME Switches in Encoder mode

Time switch is to convert output pulse width(Tw).

TIME SWITCH	Max. input frequency	Output pulse width(Tw)	Input speed of connected equipment(cps)
	100KHz	Approx. 0.5μs	Min. 2000KHz(2,000kcps)
	10KHz	Approx. 5μs	Min. 200KHz(200kcps)
	1KHz	Approx. 50μs	Min. 20KHz(20kcps)
	100Hz	Approx. 500μs	Min. 2KHz(2kcps)

(A) Counter

(B) Timer

(C) Temp. controller

(D) Power controller

(E) Panel meter

(F) Tacho/ Speed/ Pulse meter

(G) Display unit

(H) Sensor controller

(I) Switching power supply

(J) Proximity sensor

(K) Photo electric sensor

(L) Pressure sensor

(M) Rotary encoder

(N) Stepping motor & Driver & Controller

(O) Graphic panel

(P) Production stoppage models & replacement

PA10 Series

Application of derivative operation

Detect label of glass bottle

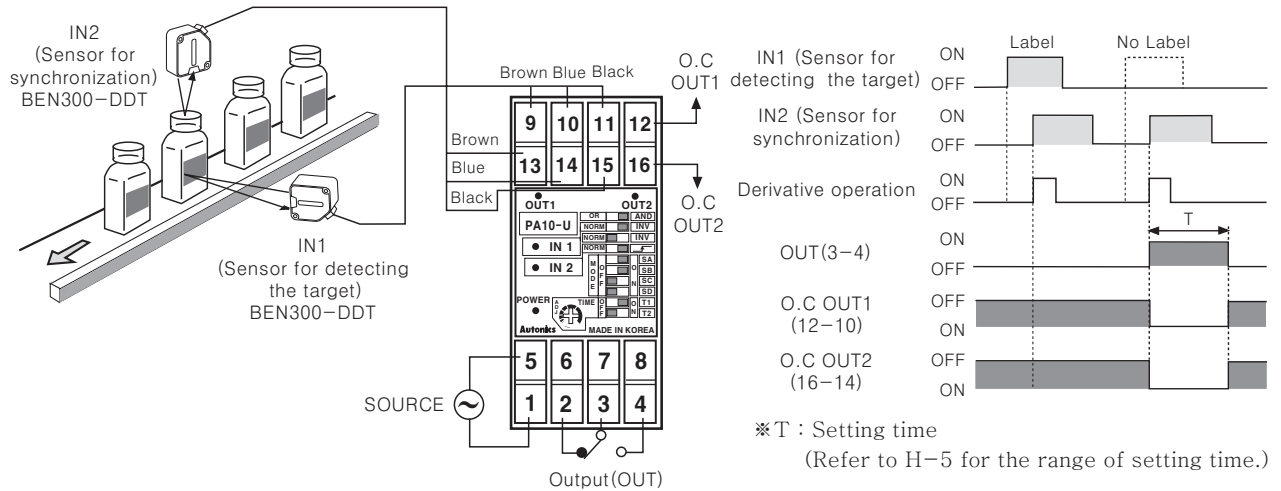

Operation

When IN2 is ON after IN1 is ON, OUT will not operate. But if there is no label on bottle, OUT will operate with IN2 is ON only. OUT will be returned after setting time.

Note) Please install the sensor (IN1) to be operated first.

Proper usage

Load connections

It is important to protect from surge or noise by installing a surge absorber across inductive loads (Motor, Solenoid, etc).

In case the load is a DC relay, please install a diode across relay as shown below.

(Be careful of polarity.)

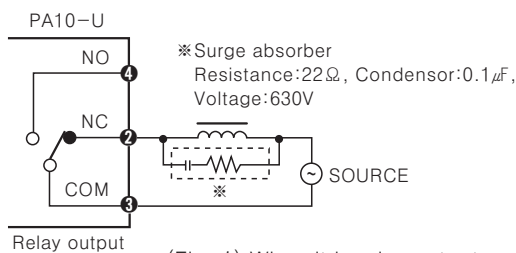

(Fig. 1) When it is relay output

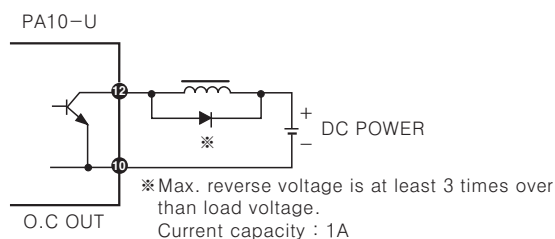

(Fig. 2) When it is NPN open collector

Input signal line

- Please make the cable line short from input sensor to this controller.
- Do not put input signal line with other power cable in the same conduit.
- When need to extend the input signal line, please use shielded cable.

Precaution for installation

When it is required to install more than two PA10, the space between two PA10 should be larger than 10mm in order for proper cooling.

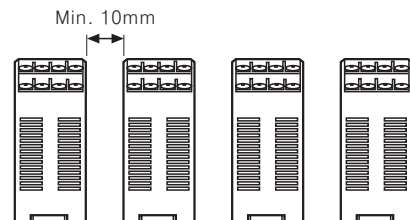

Other precautions

- Installation and dismantlement should be done with power off.
- Please check connections before wiring.
- Good ventilation must be considered to protect heating from inner components. (Ambient operating temperature is $-10^{\circ}\text{C} \sim +50^{\circ}\text{C}$.)
- Do not supply over 100-240VAC.
- Do not install this controller at place where there are dust, steam, corrosive gas, water etc.
- AC power line must be separated from O.C output line or signal input line.
- This controller has been designed to have high speed response for O.C output. If use micro switch or limit switch for signal input, chattering might be occurred at O.C output.

Sensor controller

■ Features

- Selectable use of 110/220VAC
- Selectable use of NPN, PNP input
- Able to drive loads up to 3A, 250VAC with proximity sensor or photo sensor input
- Convenient to mount on Socket by plug in type
- Output relay with both NO and NC contacts

⚠ Please read "Caution for your safety" in operation manual before using.



■ Ordering information

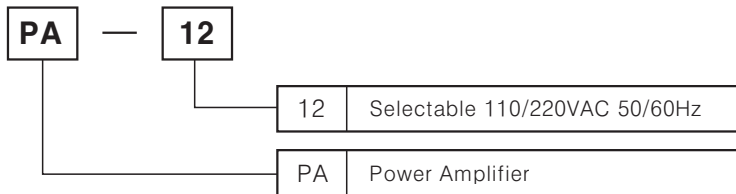

■ Specifications

Model		PA-12
Type		Selectable NPN/PNP
Power supply		Selectable 110-220VAC 50/60Hz
Power consumption		Approx. 4VA
Power for proximity sensor		12VDC 50mA
Input signal	P N P	High Level : 7-12VDC, Low Level : 0-5VDC
	N P N	Short-circuit impedance : Max. 1kΩ, Residual voltage : Max. 2VDC, Open-circuit impedance : Min. 100kΩ
Response time	Input	Max. 0.2ms
	Output	Max. 10ms
Input resistance		10kΩ
Control output	Contact composition	SPDT(1a1b)
	Contact capacity	250VAC 3A(For resistive load)
Ambient temperature		-10 ~ +50℃ (at non-freezing status)
Ambient humidity		45 ~ 85%RH
Relay life cycle	Mechanical	Min. 10,000,000 times
	Electrical	Min. 100,000 times(250VAC 3A resistive load)
Unit weight		Approx. 269g

■ Front panel identification

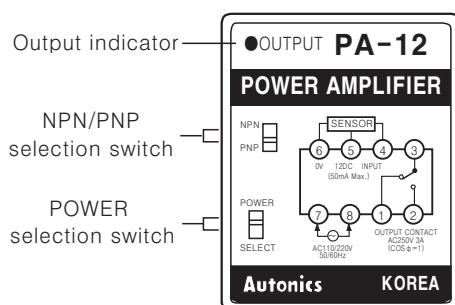

■ Connections

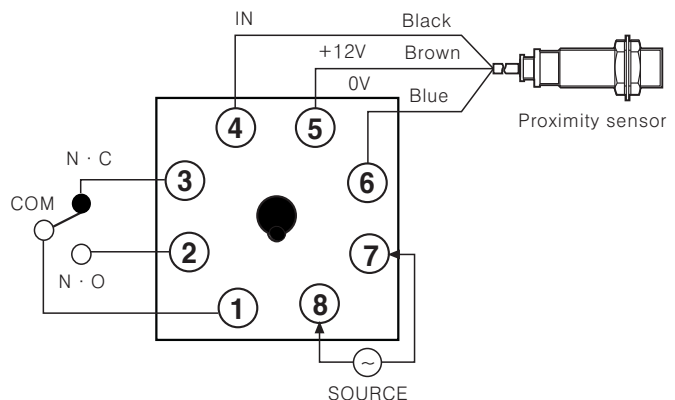

(A) Counter

(B) Timer

(C) Temp. controller

(D) Power controller

(E) Panel meter

(F) Tacho/Speed/Pulse meter

(G) Display unit

(H) Sensor controller

(I) Switching power supply

(J) Proximity sensor

(K) Photo electric sensor

(L) Pressure sensor

(M) Rotary encoder

(N) Stepping motor & Driver & Controller

(O) Graphic panel

(P) Production stoppage models & replacement

PA-12

Function diagram

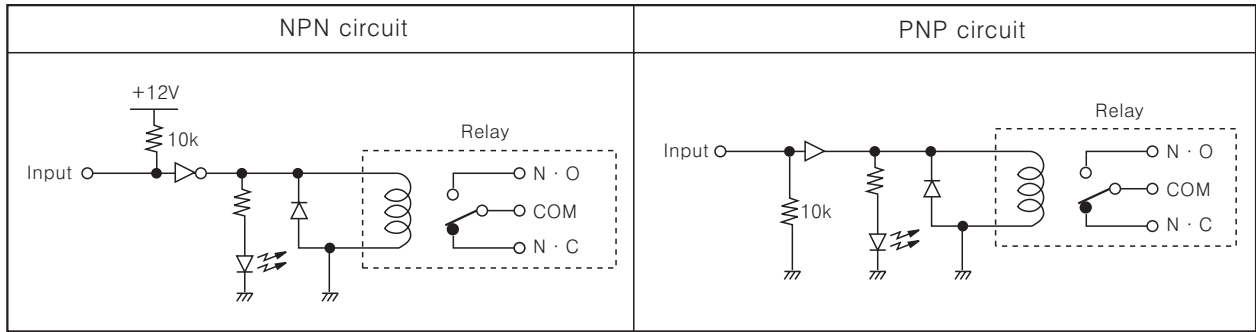

Operation mode

Input	NPN	PNP
Input level		
Relay output	NO NC	NO NC
LED	ON OFF	ON OFF

Dimensions

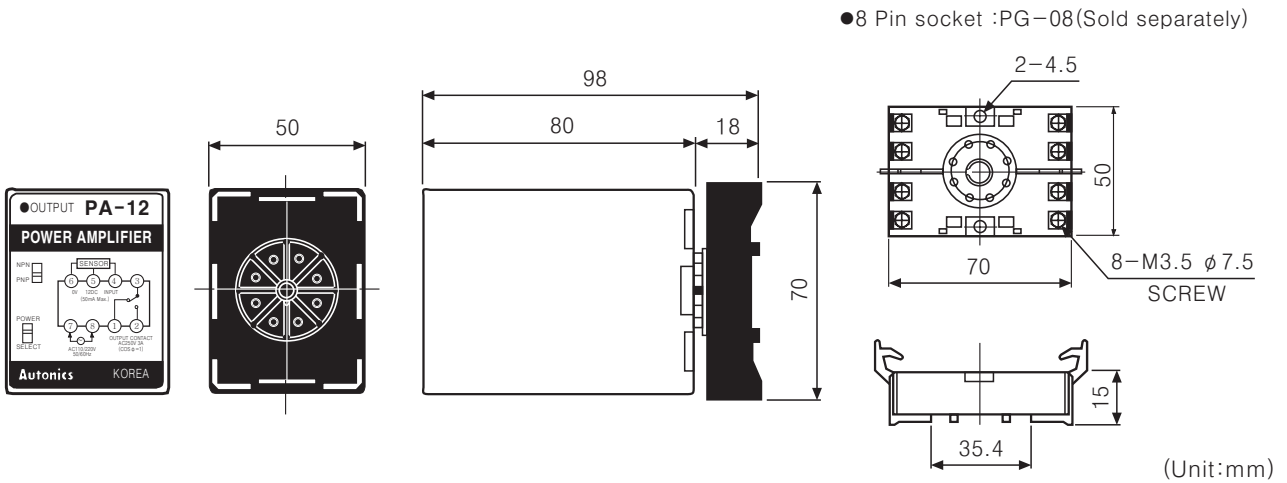

Proper usage

1. Power selection switch is set according to power voltage.
2. Please check connections before wiring.
3. Please be cautious not to short-circuit the 12VDC terminal at GND.
4. Do not install this unit at place where steam, dust, corrosive gas and water exist.

Application 1

○When the bottle is fallen

When the bottle is standing, IN1, IN2 are ON and when the bottle is fallen, IN2 is ON only. Therefore, it detects the fallen bottle when IN1, IN2 are ON by using (AND) operation.

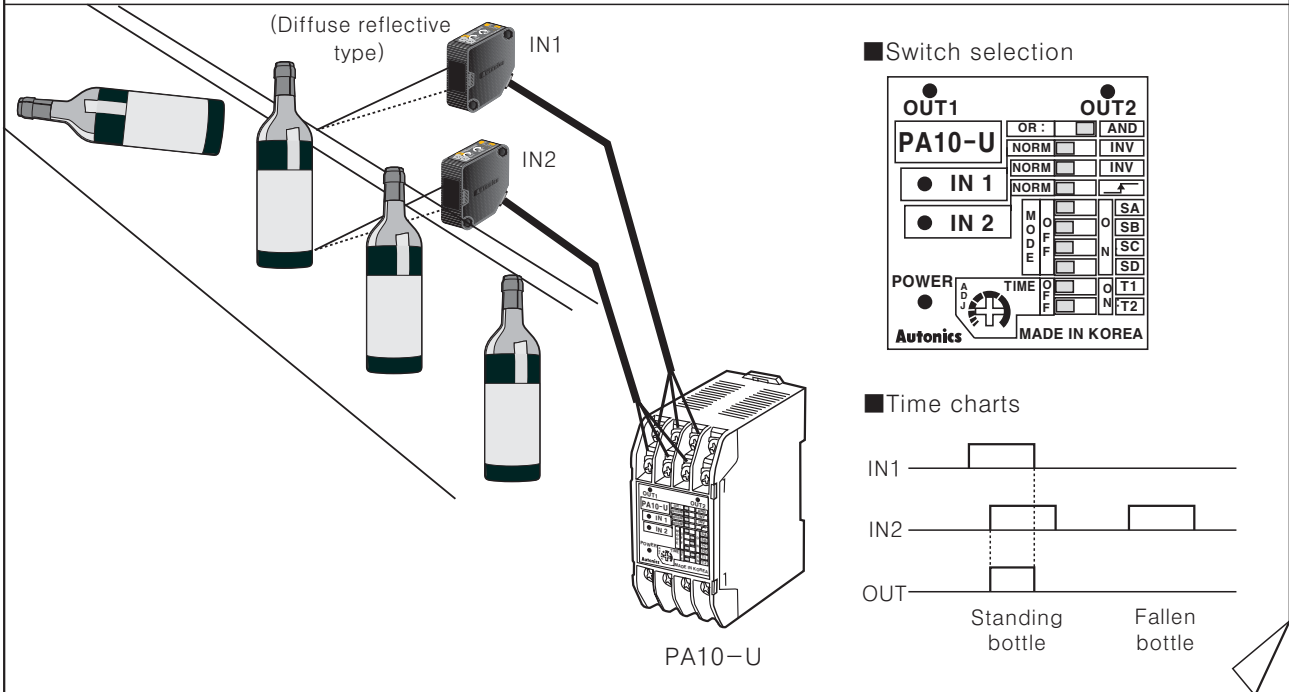

Application 2

○Detecting the thread of screw

- IN1 is for detecting the screw and IN2 is for detecting the thread of screw.
- IN1 and IN2 are ON, OUT will be ON then automatically returned after setting time (T). (One shot delay)
- IN1 should be operating faster than IN2 and IN2, IN1 should be operating at once.

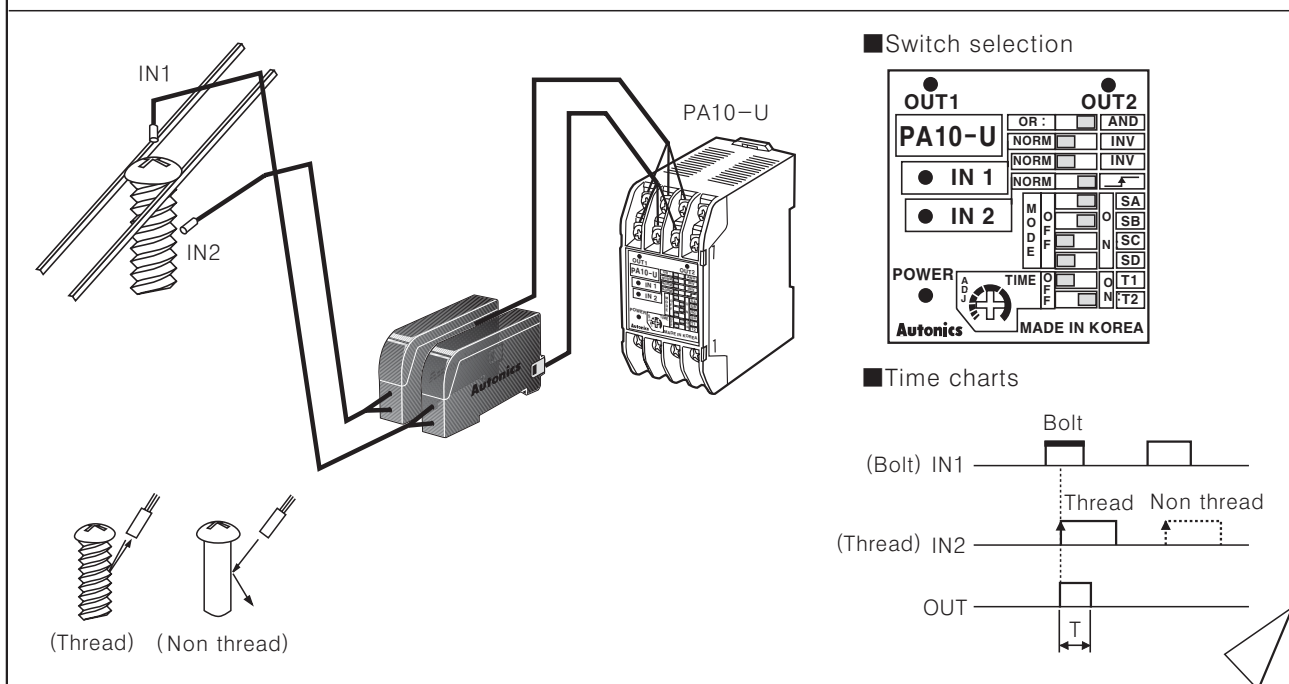

(A) Counter

(B) Timer

(C) Temp. controller

(D) Power controller

(E) Panel meter

(F) Tacho/Speed/Pulse meter

(G) Display unit

(H) Sensor controller

(I) Switching power supply

(J) Proximity sensor

(K) Photo electric sensor

(L) Pressure sensor

(M) Rotary encoder

(N) Stepping motor & Driver & Controller

(O) Graphic panel

(P) Production stoppage models & replacement

Application

Application 3

○Injecting constant volume of liquid

IN1 and IN2 are ON, OUT will be ON then automatically returned after setting time(T).

(One shot delay)

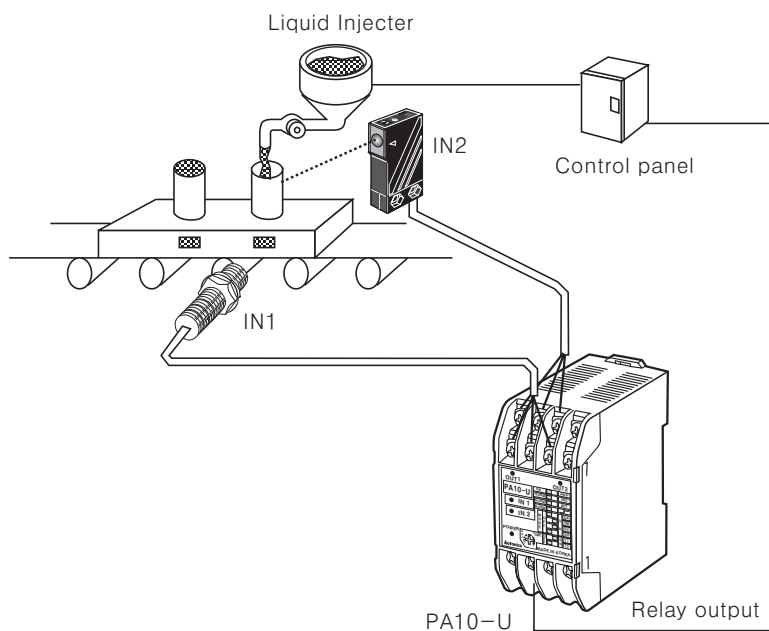

Switch selection

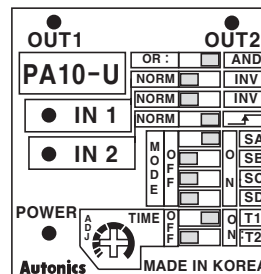

Time charts

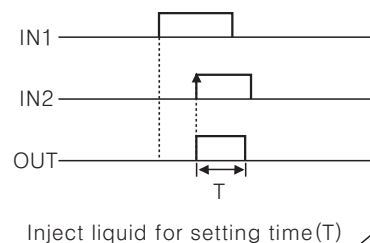

Application 4

○Detecting location of sheet

Install two sensors at both edges, when IN1 and IN2 are OFF, it is operating normally.

When one of them is ON, it detects that one side of sheet has moved and then output will be ON.

If IN1 and IN2 signal is ON then OFF, Output will be OFF after setting time(T).(OFF delay)

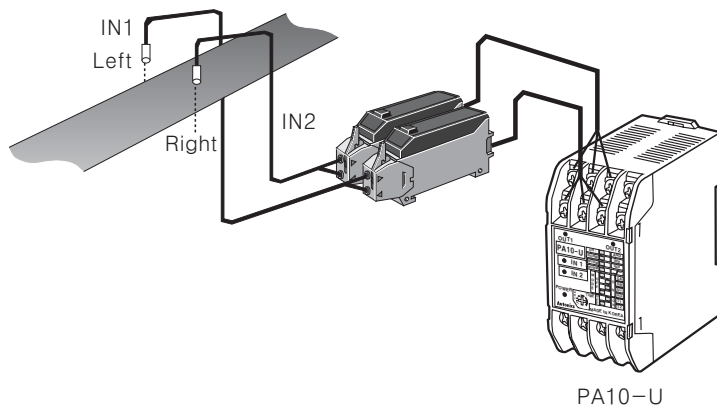

Switch selection

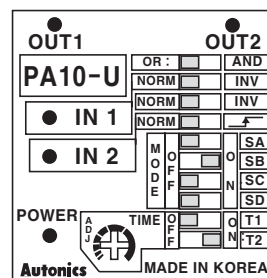

Time charts

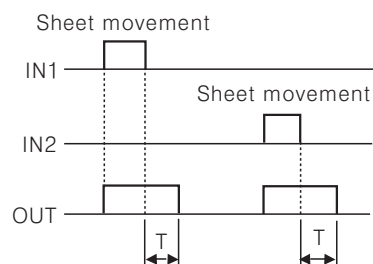

Application 5

○ Sensing a problem with the conveyor

The output will be ON when there is no input signal within setting time. (Low-speed DETECTION mode)

Ex) When set as 3 sec. for T (setting time)

When there is no input signal within 3sec., the output will be ON and it is able to stop the motor by this output.

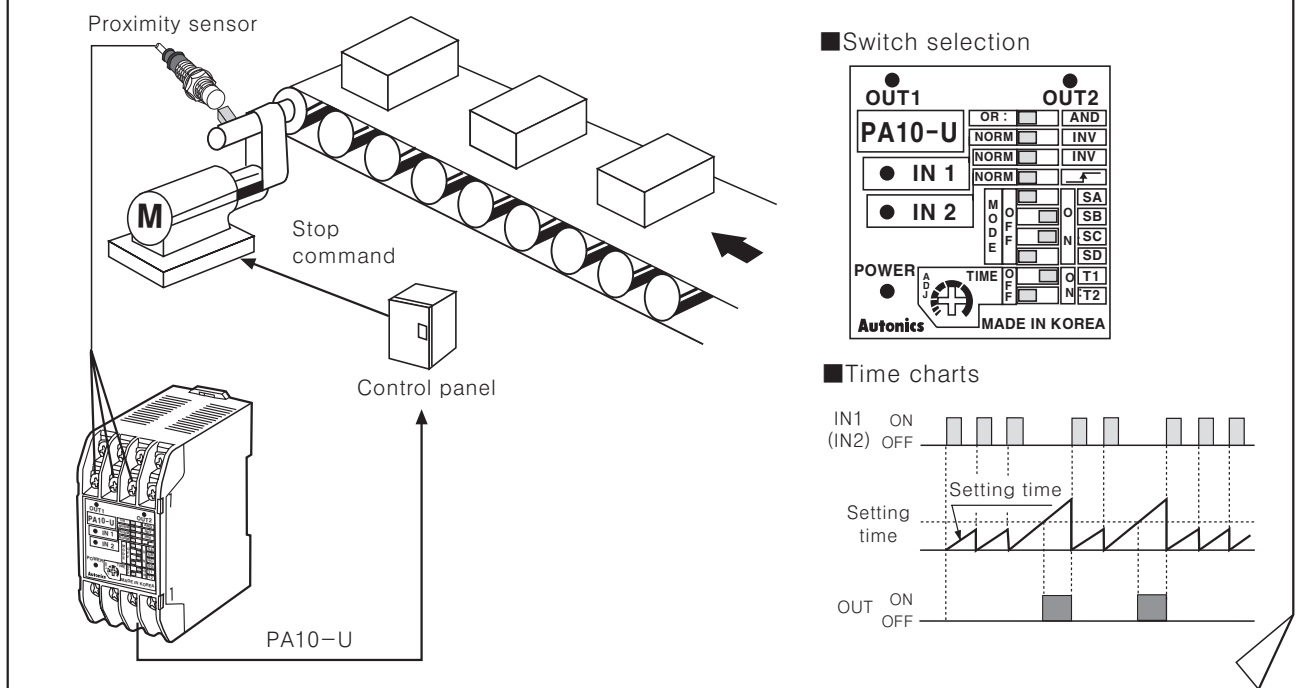

(A) Counter

(B) Timer

(C) Temp. controller

(D) Power controller

(E) Panel meter

(F) Tacho/Speed/Pulse meter

(G) Display unit

(H) Sensor controller

(I) Switching power supply

(J) Proximity sensor

(K) Photo electric sensor

(L) Pressure sensor

(M) Rotary encoder

(N) Stepping motor & Driver & Controller

(O) Graphic panel

(P) Production stoppage models & replacement