



SENSORS WITH ANALOG OUTPUT



SENSORS WITH ANALOG OUTPUT

Classical (switching) proximity switches work internally as analog devices, although they produce a binary signal at the output. A large part of the available internal information, though, is lost. Switches with analog outputs, on the other hand, provide the user with full information, permitting a variety of possible applications.

TECHNOLOGY

As mentioned above, proximity switches already work as analog devices. However, a signal shaper before the output stage changes the rectified analog signal into a digital one. This signal shaper also exists in switches with analog outputs, but there it serves an entirely different purpose. Instead of producing a switching point, it converts the signal emitted by the rectifier into a more usable, but still analog, form. Its main purpose is the generation of defined starting and end points of the output function, as well as a defined flow in between. Such switches have been available on the market for some time. The scope of their application has, however, so far remained very small, principally due to severe limitations of their usable sensing range.

ADVANTAGES OF ANALOG TECHNOLOGY

- Very large sensing range
- Available in an economical non-linearized execution with favorable transfer function
- Low specimen scattering
- Current and voltage output in the same device (most models)

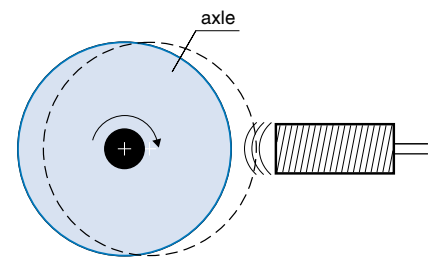

APPLICATION AREAS

Contrinex proposes a number of inductive, photoelectric and ultrasonic devices with analog output. The use of analog sensor technology permits the realization of numerous applications.

- The regulated approach to end positions at minimum cost
- The realization of several switch points with a single device
- Concentricity monitoring (Fig. 1)
- Vibration monitoring

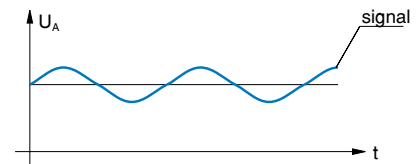
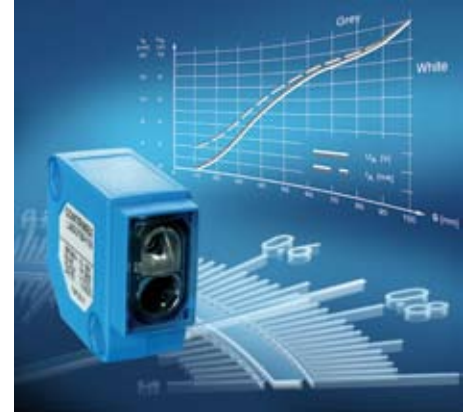
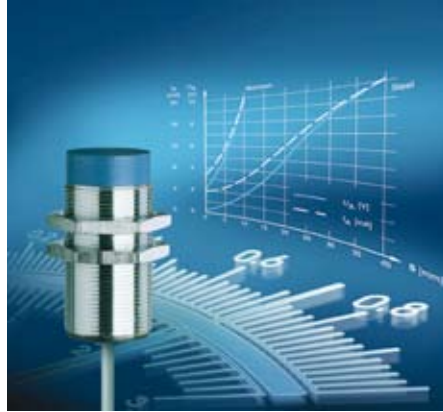

Fig. 1

For further application possibilities, please consult the Contrinex technical notes on sensors with analog output.





INDUCTIVE ANALOG DEVICES

Contrinex inductive analog sensors use Condist® technology for particularly large sensing ranges. In addition, these devices are characterized by good switching accuracy, stability, and repeat accuracy, as well as low specimen scattering.

For most models, a voltage output (0 ... 5 V or 0 ... 10 V) and a current output (1 ... 5 mA or 4 ... 20 mA) are available simultaneously. Presently, all devices demonstrate non-linear transmission behaviour, as shown in Fig. 2 for DW-A#-509-M12.

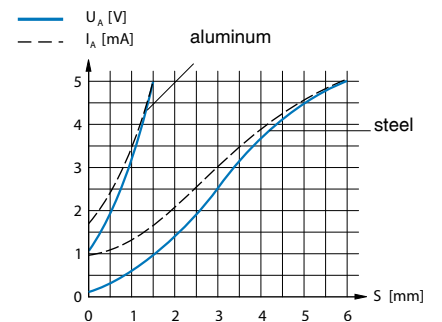

Fig. 2

PHOTOELECTRIC ANALOG DEVICES

In order to enlarge its range of analog sensors, Contrinex now also offers photoelectric sensors with analog output. The devices feature a large sensing range, excellent temperature stability and an outstanding repeat accuracy. The sensing range is furthermore independent of the target color and surface structure. Since intermediate digitalisation has been dispensed with, the resolution of these sensors is virtually unlimited. In addition, their excellent white-gray characteristics allow for efficient background suppression.

ULTRASONIC ANALOG DEVICES

Ultrasonic proximity switches can be used as contact-free sensors in many areas of automation. They are employed wherever distances have to be measured in air, since they not only detect objects, but they can also indicate and evaluate the absolute distance between themselves and the target. Changing atmospheric conditions, such as temperature variations for instance, are compensated during the evaluation process of the measurement. The ultrasonic range includes devices with analog and switching outputs.



MAIN FEATURES

- Large usable sensing ranges
- Excellent resolution (no digitalization)
- Excellent temperature stability
- Voltage as well as current outputs in the same device (most models)
- Switch point setting by teach-in (in conjunction with a PLC)
- Rectangular version (housing 8 x 8 x 50) for easier installation in limited spaces

TECHNICAL DATA

Housing material	Chrome-plated brass
Supply voltage range U_B	10 ... 30 / 15 ... 30 VDC*
Permissible ripple content	≤ 20 %
No-load supply current	≤ 10 mA
Output voltage, damped	0 VDC
Output voltage, non-damped	5 VDC / 10 VDC*
Ambient temperature range	-25 ... +70 °C**
Temperature drift % s_t	≤ 5 % (0 ... +70 °C)
	≤ 10 % (-25 ... 0 °C)
Degree of protection	IP 67
EMC protection:	
IEC 60947-5-2	5 kV
IEC 61000-4-2	Level 2
IEC 61000-4-3	Level 3
IEC 61000-4-4	Level 2
Short-circuit protection	Built-in
Polarity reversal protection	Built-in
Power-on reset	Built-in

* DW-A#-5#9-M##-320/39#

** Depending on operating conditions, limited temperature range for DW-A#-509-M##-320/39# (see data sheets)

DOCUMENTATION

Detailed data sheets for these products can be found on the CONTRINEX website www.contrinex.com or ordered free of charge from our distributors.

Technical drawings can be downloaded as files from the CONTRINEX website and directly imported into your construction drawings.

SERIES 509

0 ... 4 mm

0 ... 4 mm

0 ... 4 mm

0 ... 4 mm

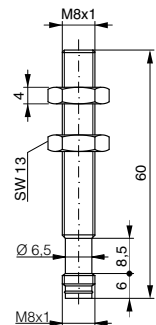
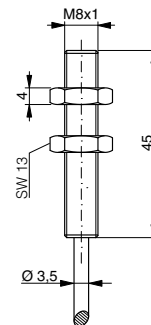
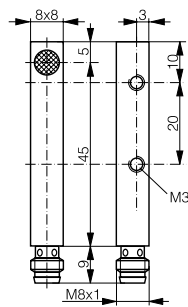
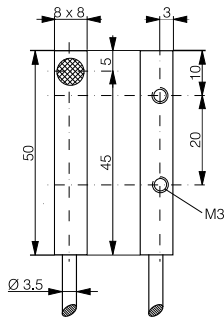
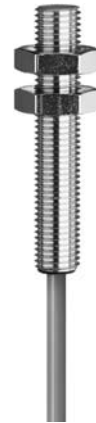

Dimensions:

TYPE SPECIFIC DATA

Housing size	8 x 8	8 x 8	M8	M8
Sensing range	0 ... 4 mm	0 ... 4 mm	0 ... 4 mm	0 ... 4 mm
Connection	PUR cable 2 m*	Connector S8 3-pole	PUR cable 2 m*	Connector S8 3-pole
Bandwidth (-3 dB)	1,600 Hz (at s = 2 mm)	1,600 Hz (at s = 2 mm)	1,600 Hz (at s = 2 mm)	1,600 Hz (at s = 2 mm)
Mounting	Quasi-embeddable	Quasi-embeddable	Quasi-embeddable	Quasi-embeddable
Voltage output	0 ... 10 V	0 ... 10 V	0 ... 5 V / 0 ... 10 V	0 ... 5 V / 0 ... 10 V
Current output	---	---	---	---

PART REFERENCES

Part ref.: (bold : preferred types)				
Non-linearized:				
Outputs 0...5 V / 1...5 mA	---	---	DW-AD-509-M8	DW-AS-509-M8-001
Outputs 0...10 V / 4...20 mA	DW-AD-509-C8-390	DW-AS-509-C8-390	DW-AD-509-M8-390	DW-AS-509-M8-390
Wiring (page 19)	Diagram 1	Diagram 1	Diagram 1	Diagram 1

* Other cable lengths and types on request.

SERIES 509

0 ... 4 mm

0 ... 6 mm

0 ... 6 mm

0 ... 6 mm

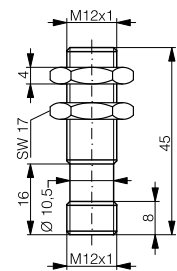
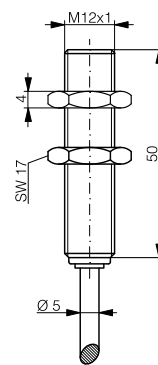
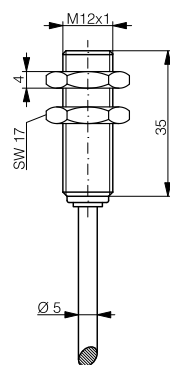
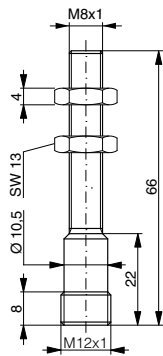

Dimensions:

TYPE SPECIFIC DATA

Housing size	M8	M12	M12	M12
Sensing range	0 ... 4 mm	0 ... 6 mm	0 ... 6 mm	0 ... 6 mm
Connection	Connector S12 4-pole	PUR cable 2 m*	PUR cable 2 m*	Connector S12 4-pole
Bandwidth (-3 dB)	1,600 Hz (at s = 2 mm)	1,000 Hz (at s = 3 mm)	1,000 Hz (at s = 3 mm)	1,000 Hz (at s = 3 mm)
Mounting	Quasi-embeddable	Quasi-embeddable	Quasi-embeddable	Quasi-embeddable
Voltage output	0 ... 5 V / 0 ... 10 V	0 ... 5 V / 0 ... 10 V	0 ... 5 V / 0 ... 10 V	0 ... 5 V / 0 ... 10 V
Current output	---	1 ... 5 mA	1 ... 5 mA / 4 ... 20 mA	1 ... 5 mA

PART REFERENCES

Part ref.: (bold: preferred types)				
Non-linearized:				
Outputs 0...5 V / 1...5 mA	DW-AS-509-M8	DW-AD-509-M12-120	DW-AD-509-M12	DW-AS-509-M12-120
Outputs 0...10 V / 4...20 mA	DW-AS-509-M8-393	DW-AD-509-M12-320**	DW-AD-509-M12-390	DW-AS-509-M12-320**
Wiring (page 19)	Diagram 1	Diagram 2	Diagram 2	Diagram 2

* Other cable lengths and types on request.

** Without current output

0 ... 6 mm

0 ... 10 mm

0 ... 10 mm

0 ... 10 mm

0 ... 10 mm

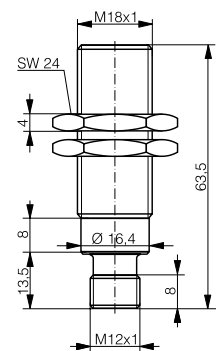
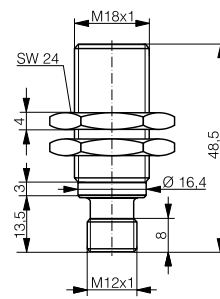
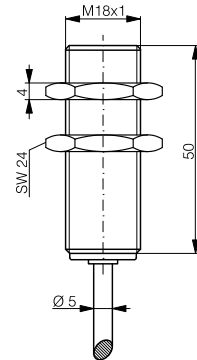
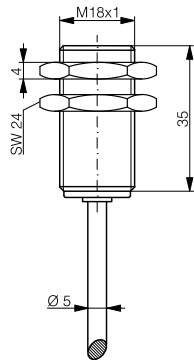
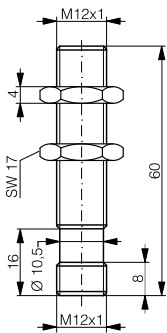

M12	M18	M18	M18	M18
0 ... 6 mm	0 ... 10 mm	0 ... 10 mm	0 ... 10 mm	0 ... 10 mm
Connector S12 4-pole	PUR cable 2 m*	PUR cable 2 m*	Connector S12 4-pole	Connector S12 4-pole
1,000 Hz (at s = 3 mm)	500 Hz (at s = 5 mm)	500 Hz (at s = 5 mm)	500 Hz (at s = 5 mm)	500 Hz (at s = 5 mm)
Quasi-embeddable	Quasi-embeddable	Quasi-embeddable	Quasi-embeddable	Quasi-embeddable
0 ... 5 V / 0 ... 10 V	0 ... 5 V / 0 ... 10 V	0 ... 5 V / 0 ... 10 V	0 ... 5 V / 0 ... 10 V	0 ... 5 V / 0 ... 10 V
1 ... 5 mA / 4 ... 20 mA	1 ... 5 mA / 4 ... 20 mA	1 ... 5 mA / 4 ... 20 mA	1 ... 5 mA / 4 ... 20 mA	1 ... 5 mA / 4 ... 20 mA

DW-AS-509-M12	DW-AD-509-M18-120	DW-AD-509-M18	DW-AS-509-M18-120	DW-AS-509-M18-002
DW-AS-509-M12-390	DW-AD-509-M18-320	DW-AD-509-M18-390	DW-AS-509-M18-320	DW-AS-509-M18-390
Diagram 2	Diagram 2	Diagram 2	Diagram 2	Diagram 2

SERIES 509

0 ... 20 mm

0 ... 20 mm

0 ... 20 mm

0 ... 20 mm

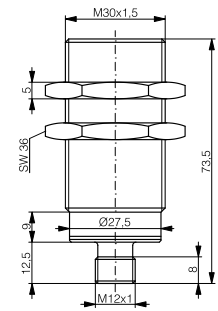
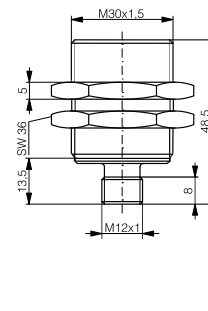
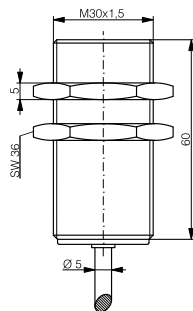
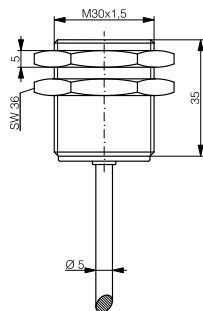

Dimensions:

TYPE SPECIFIC DATA

Housing size	M30	M30	M30	M30
Sensing range	0 ... 20 mm	0 ... 20 mm	0 ... 20 mm	0 ... 20 mm
Connection	PUR cable 2 m*	PUR cable 2 m*	Connector S12 4-pole	Connector S12 4-pole
Bandwidth (-3 dB)	200 Hz (at s = 10 mm)	200 Hz (at s = 10 mm)	200 Hz (at s = 10 mm)	200 Hz (at s = 10 mm)
Mounting	Quasi-embeddable	Quasi-embeddable	Quasi-embeddable	Quasi-embeddable
Voltage output	0 ... 5 V / 0 ... 10 V	0 ... 5 V / 0 ... 10 V	0 ... 5 V / 0 ... 10 V	0 ... 5 V / 0 ... 10 V
Current output	1 ... 5 mA / 4 ... 20 mA	1 ... 5 mA / 4 ... 20 mA	1 ... 5 mA / 4 ... 20 mA	1 ... 5 mA / 4 ... 20 mA

PART REFERENCES

Part ref.: (bold: preferred types)				
Non-linearized:				
Outputs 0...5 V / 1...5 mA	DW-AD-509-M30-120	DW-AD-509-M30	DW-AS-509-M30-120	DW-AS-509-M30-002
Outputs 0...10 V / 4...20 mA	DW-AD-509-M30-320	DW-AD-509-M30-390	DW-AS-509-M30-320	DW-AS-509-M30-390
Wiring (page 19)	Diagram 2	Diagram 2	Diagram 2	Diagram 2

* Other cable lengths and types on request.

0 ... 40 mm

0 ... 40 mm

0 ... 40 mm

0 ... 40 mm

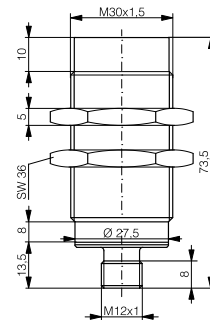
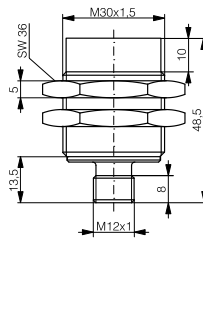
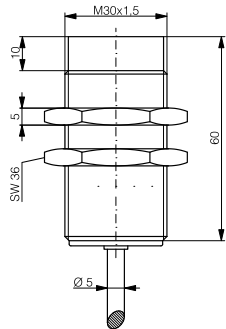
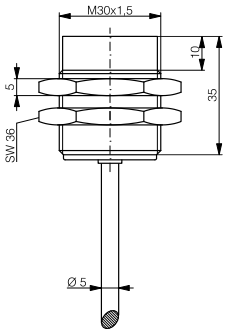

M30	M30	M30	M30	
0 ... 40 mm	0 ... 40 mm	0 ... 40 mm	0 ... 40 mm	
PUR cable 2 m*	PUR cable 2 m*	Connector S12 4-pole	Connector S12 4-pole	
100 Hz (at s = 20 mm)	100 Hz (at s = 20 mm)	100 Hz (at s = 20 mm)	100 Hz (at s = 20 mm)	
Non-embeddable	Non-embeddable	Non-embeddable	Non-embeddable	
0 ... 5 V / 0 ... 10 V	0 ... 5 V / 0 ... 10 V	0 ... 5 V / 0 ... 10 V	0 ... 5 V / 0 ... 10 V	
1 ... 5 mA / 4 ... 20 mA	1 ... 5 mA / 4 ... 20 mA	1 ... 5 mA / 4 ... 20 mA	1 ... 5 mA / 4 ... 20 mA	

DW-AD-519-M30-120	DW-AD-519-M30	DW-AS-519-M30-120	DW-AS-519-M30-002	
DW-AD-519-M30-320	DW-AD-519-M30-390	DW-AS-519-M30-320	DW-AS-519-M30-390	
Diagram 2	Diagram 2	Diagram 2	Diagram 2	

PHOTOELECTRIC ANALOG



DIFFUSE SENSORS

MAIN FEATURES

- Small housing size
- Sensing range from 10 ... 100 mm
- Excellent resolution
- Excellent temperature stability
- Voltage output of 0 ... 5 V
- Operating distance independent of target color and surface structure
- Bandwidth of 100 Hz
- Glass lens, easy to clean

TECHNICAL DATA

Housing material	Chrome-plated brass
Supply voltage range U_B	10 ... 30 VDC
Permissible ripple content	≤ 20 %
No-load supply current	≤ 25 mA
Time delay before availability	≤ 100 msec
Max. ambient light:	
halogen	5,000 Lux
sun	10,000 Lux
Ambient temperature range	0 ... +55 °C
Temperature drift % s_n	0.1 / °C
Degree of protection	IP 67
EMC protection:	
IEC 60947-5-2	1 kV
IEC 61000-4-2	Level 2
IEC 61000-4-3	Level 2
IEC 61000-4-4	Level 3
IEC 61000-4-6	Level 2
Short-circuit protection	Built-in
Polarity reversal protection	Built-in
Power-on reset	Built-in

DOCUMENTATION

Detailed data sheets for these products can be found on the CONTRINEX website www.contrinex.com or ordered free of charge from our distributors.

Technical drawings can be downloaded as files from the CONTRINEX website and directly imported into your construction drawings.

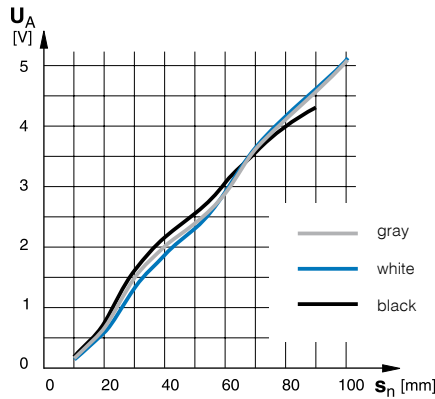
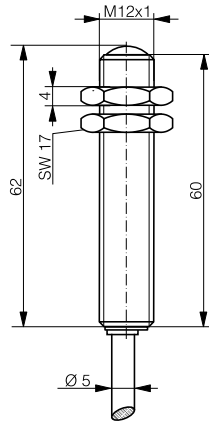

Response curve:

TYPE SPECIFIC DATA

Housing size	M12	
Sensing range	10 ... 100 mm	
Standard target	100 x 100 mm white	
Bandwidth (-3 dB)	100 Hz (at s = 50 mm)	
Emitter	LED red 660 nm	
Voltage output	0 ... 5 V	
Current output	---	

PART REFERENCES

Part ref.: (bold : preferred types)		
Output 0 ... 5 V / PVC cable 2 m*	LAK-1120-309	
Wiring (page 19)	Diagram 1	

* Other cable lengths and types on request.

PHOTOELECTRIC ANALOG



DIFFUSE SENSORS

MAIN FEATURES

- Sensing range from 10 ... 100 mm
- Excellent resolution (no digitalization)
- Excellent temperature stability
- Voltage as well as current outputs in the same device
- Operating distance independent of target color and surface structure
- Bandwidth of 500 Hz
- Glass window, easy to clean
- Extremely resistant and fully-potted PBTP (Crastin) housing

TECHNICAL DATA

Housing material	Glass-fiber reinforced PBTP (Crastin)
Supply voltage range U_B	10 ... 36 VDC / 15 ... 36 VDC (LA#-3130-119)
Permissible ripple content	≤ 20 %
No-load supply current	≤ 25 mA
Time delay before availability	≤ 100 msec
Max ambient light:	
halogen	5,000 Lux
sun	10,000 Lux
Ambient temperature range	-25 ... +55 °C
Temperature drift % s_n	0.1 / °C
Degree of protection	IP 67
EMC protection:	
IEC 60947-5-2	5 kV
IEC 61000-4-2	Level 3
IEC 61000-4-3	Level 3
IEC 61000-4-4	Level 3
IEC 61000-4-6	Level 2
Short-circuit protection	Built-in
Polarity reversal protection	Built-in
Power-on reset	Built-in

DOCUMENTATION

Detailed data sheets for these products can be found on the CONTRINEX website www.contrinex.com or ordered free of charge from our distributors.

Technical drawings can be downloaded as files from the CONTRINEX website and directly imported into your construction drawings.

SERIES 3130

10 ... 100 mm

10 ... 100 mm

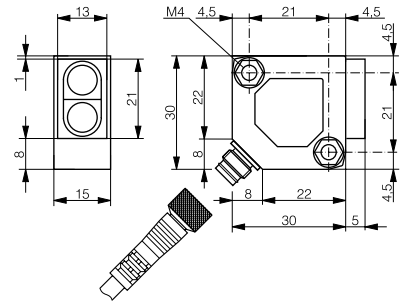
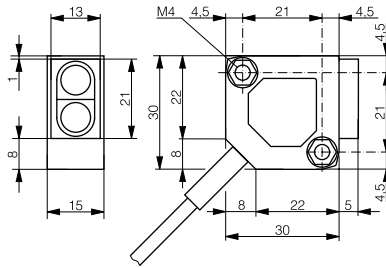

Response curves:

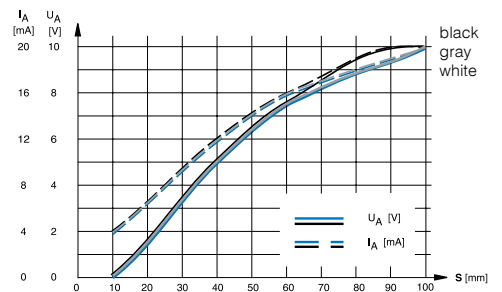
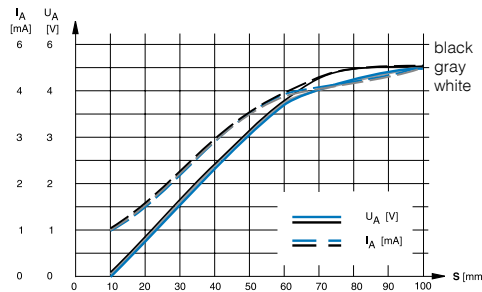

TYPE SPECIFIC DATA

Housing size	□ 30 x 30 x 15	□ 30 x 30 x 15
Sensing range	10 ... 100 mm	10 ... 100 mm
Standard target	100 x 100 mm white	100 x 100 mm white
Bandwidth (-3 dB)	500 Hz (at s = 50 mm)	500 Hz (at s = 50 mm)
Emitter	LED red 660 nm	LED red 660 nm
Voltage output	0 ... 5 V	0 ... 10 V
Current output	1 ... 5 mA	4 ... 20 mA

PART REFERENCES

Part ref.: (bold : preferred types)		
Voltage and current outputs / PVC cable 2 m*	LAK-3130-109	LAK-3130-119
Voltage and current outputs / Connector S8 4-pole	LAS-3130-109	LAS-3130-119
Wiring (page 19)	Diagram 2	Diagram 2

* Other cable lengths and types on request.

ULTRASONIC ANALOG



SENSORS

MAIN FEATURES

- Ready-to-connect compact devices
- Can be operated as diffuse or reflex sensors
- High excess gain, therefore insensitive to dirt and ambient noise
- Detection independent of target color, shape, material and surface structure
- Reduced blind zone
- Low current drain
- Adjustment by means of interface device APE-0000-001
- Fore- and background suppression
- Diffuse sensors with window function
- High degree of protection: IP 67

TECHNICAL DATA

Housing material	Nickel-plated brass
Supply voltage range U_b	12 ... 30 VDC*
Permissible ripple content	≤ 10 %
Current output	4 ... 20 mA
No-load supply current	≤ 50 mA
Time delay before availability	280 msec
Ambient temperature range	-25 ... +70 °C
Degree of protection	IP 67
EMC protection:	
IEC 61000-4-2	4 kV
IEC 61000-4-3	10 V/m
IEC 61000-4-4	2 kV
IEC 61000-4-6	10 V
EN 55011	Class B
Short-circuit protection	Built-in
Polarity reversal protection	Built-in
Power-on reset	Built-in

* At 12 ... 20 V, approx. 20 % reduced sensing range

LED

The yellow LED lights up when the output is switched. Flashing LED indicates misadjustment.

DOCUMENTATION

Detailed data sheets for these products can be found on the CONTRINEX website www.contrinex.com or ordered free of charge from our distributors.

Technical drawings can be downloaded as files from the CONTRINEX website and directly imported into your construction drawings.

SERIES 1180/1181

50 ... 300 mm

150 ... 1,000 mm

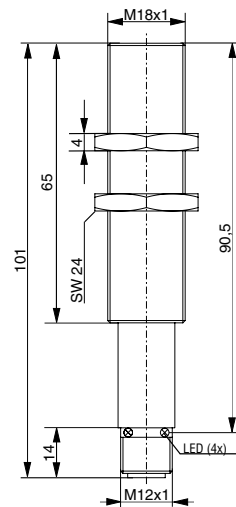
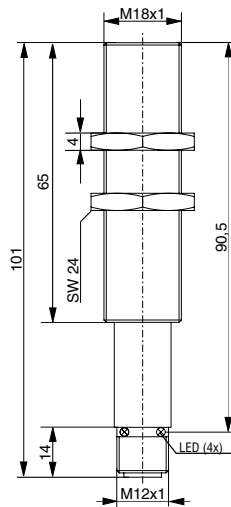

Dimensions:

TYPE SPECIFIC DATA

Housing size	M18	M18
Sensing range	50 ... 300 mm	150 ... 1,000 mm
Setting range	70 ... 300 mm	170 ... 1,000 mm
Standard target	10 x 10 mm	20 x 20 mm
Hysteresis	10 mm	10 mm
Rated ultrasonic frequency	400 kHz	200 kHz
Response time	100 msec	120 msec
Voltage output	---	---
Current output	4 ... 20 mA	4 ... 20 mA

PART REFERENCES

Part ref.: (bold : preferred types)		
Output 4 ... 20 mA / Connector S12 4-pole	UTS-1180-329	UTS-1181-329
Wiring (page 19)	Diagram 3	Diagram 3

ULTRASONIC ANALOG



SENSORS

MAIN FEATURES

- Ready-to-connect compact devices
- Can be operated as diffuse or reflex sensors
- High excess gain, therefore insensitive to dirt and ambient noise
- Detection independent of target color, shape, material and surface structure
- Reduced blind zone
- Low current drain
- Adjustment by means of potentiometers and interface device APE-0000-001
- Switching and analog outputs
- Fore- and background suppression
- Diffuse sensors with window function
- High degree of protection: IP 65

TECHNICAL DATA

Housing material	Nickel-plated brass
Supply voltage range U_B	12 ... 30 VDC*
Permissible ripple content	≤ 10 %
Output current	300 mA max.
Output voltage drop	3.0 V max. at 300 mA
No-load supply current	≤ 60 mA
Time delay before availability	280 msec
Ambient temperature range	-25 ... +70 °C
Degree of protection	IP 65
EMC protection:	
IEC 61000-4-2	4 kV
IEC 61000-4-3	10 V/m
IEC 61000-4-4	2 kV
IEC 61000-4-6	10 V
EN 55011	Class B
Short-circuit protection	Built-in
Polarity reversal protection	Built-in
Power-on reset	Built-in

* At 12 ... 20 V, approx. 20 % reduced sensing range

LED

The yellow LED lights up when the output is switched. Flashing LED indicates misadjustment.

DOCUMENTATION

Detailed data sheets for these products can be found on the CONTRINEX website www.contrinex.com or ordered free of charge from our distributors.

Technical drawings can be downloaded as files from the CONTRINEX website and directly imported into your construction drawings.

SERIES 1300...1303

60 ... 300 mm

200 ... 1,300 mm

400 ... 3,000 mm

600 ... 6,000 mm

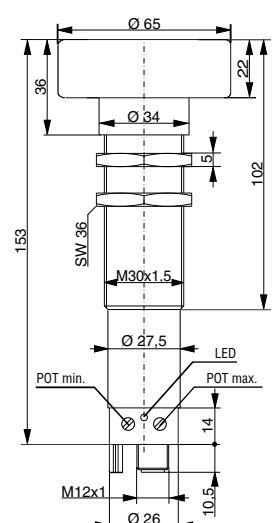
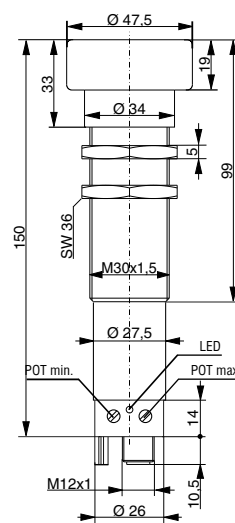
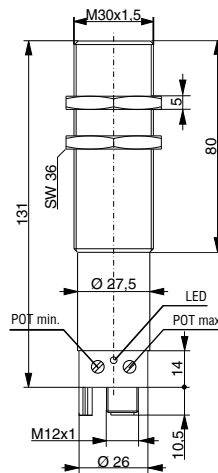
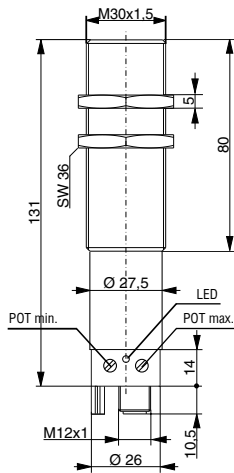

Dimensions:

TYPE SPECIFIC DATA

Housing size	M30	M30	M30	M30
Sensing range	60 ... 300 mm	200 ... 1,300 mm	400 ... 3,000 mm	600 ... 6,000 mm
Setting range	80 ... 300 mm	220 ... 1,300 mm	420 ... 3,000 mm	640 ... 6,000 mm
Standard target	10 x 10 mm	20 x 20 mm	50 x 50 mm	100 x 100 mm
Hysteresis	10 mm	10 mm	20 mm	60 mm
Rated ultrasonic frequency	400 kHz	200 kHz	120 kHz	80 kHz
Switching frequency	5 Hz	4 Hz	2 Hz	1 Hz
Response time	100 msec	120 msec	200 msec	400 msec
Voltage output	0 ... 10 V	0 ... 10 V	0 ... 10 V	0 ... 10 V
Current output	4 ... 20 mA	4 ... 20 mA	4 ... 20 mA	4 ... 20 mA

PART REFERENCES

Part ref.: (bold : preferred types)				
4...20 mA + PNP N.O. / S125-p.	UTS-1300-123	UTS-1301-123	UTS-1302-123	UTS-1303-123
0...10 V + PNP N.O. / S125-p.	UTS-1300-113	UTS-1301-113	UTS-1302-113	UTS-1303-113
Wiring (page 19)	Diagram 4 (-123) / 5 (-113)	Diagram 4 (-123) / 5 (-113)	Diagram 4 (-123) / 5 (-113)	Diagram 4 (-123) / 5 (-113)

ACCESSORIES FOR ULTRASONIC SENSORS

CONPROG PC INTERFACE

For optimum adaptation to the application conditions, the parameters of all ultrasonic devices in this catalog can be programmed, visualized, checked and changed with the PC interface device APE-0000-001 and its software CONPROG. Amongst others, the following parameters can be set:

- Beginning and end of operating range
- Hysteresis
- End of sensing range
- Switching function (N.O. or N.C.)
- Beginning and end of analog characteristic curve
- Direction of analog characteristic curve (rising or falling)
- End of blind zone
- Mean value generation
- Temperature compensation
- Multiplex function
- Function as diffuse or reflex sensor
- Switching frequency
- Damping (sensitivity)

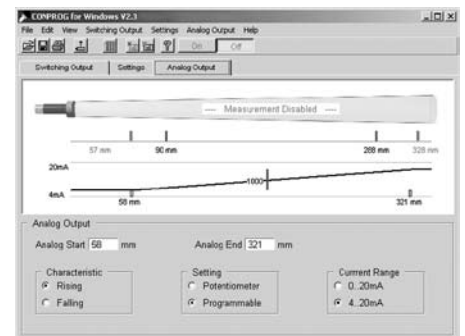
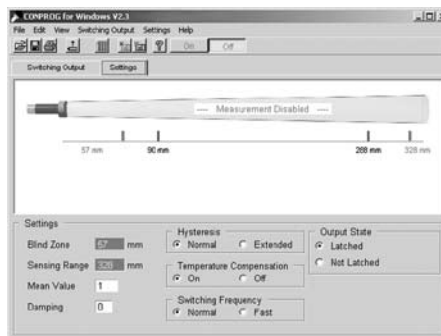

The programmed values can be stored and printed, thus simplifying the maintenance and documentation of the installation. In case several sensors need to be parametrized identically, the stored setting values can be transferred rapidly to the other sensors by means of the interface device (e.g. when connecting switches in series, or when exchanging them).

The interface device is delivered with a RS232 cable (for serial interface), a mains transformer plug, a sensor connecting cable and CONPROG PC software for Windows. Updates to the latest software version can be downloaded from the CONTRINEX website (www.contrinex.com).



PART REFERENCES

Interface device

APE-0000-001

WIRING DIAGRAMS

Diagram 1

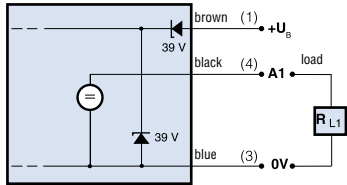
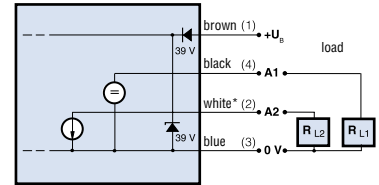

Diagram 2



* Only for models with current output

Diagram 3

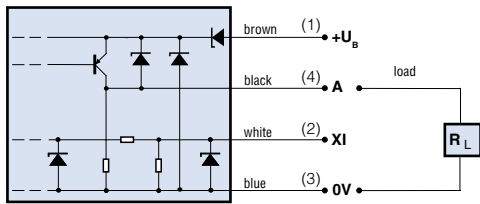

Diagram 4

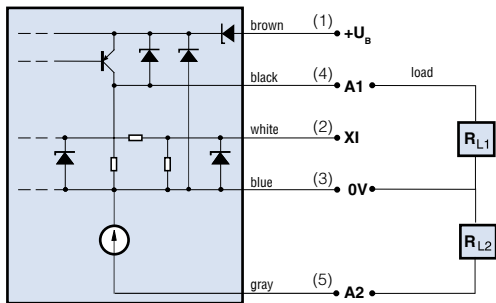
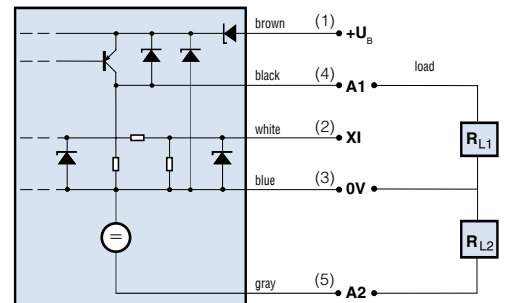

Diagram 5





CONTRINEX

ALL OVER THE WORLD

EUROPE

Austria
Belgium
Croatia
Czech Republic
Denmark
Finland
France
Germany
Great Britain
Greece
Hungary
Ireland
Italy
Luxembourg
Netherlands
Norway
Poland
Portugal
Romania
Russian Federation
Slovakia
Slovenia

Spain
Sweden
Switzerland
Turkey

AFRICA

South Africa

THE AMERICAS

Argentina
Brazil
Canada
Chile
Colombia
Mexico
United States
Venezuela

ASIA

China
India
Indonesia

Japan
Korea
Malaysia
Pakistan
Philippines
Singapore
Taiwan
Thailand
Vietnam

AUSTRALASIA

Australia
New Zealand

MIDDLE EAST

Iran
Israel
Syria
United Arab Emirates

Terms of delivery and right to change design reserved.

Contrinex AG Industrial Electronics
route André Piller 50 - PO Box - CH 1762 Givisiez - Switzerland
Tel: +41 26 460 46 46 - **Fax:** +41 26 460 46 40
Internet: www.contrinex.com - **E-mail:** info@contrinex.com