



KOGANEI

VALVES GENERAL CATALOG

SOLENOID VALVES 300 SERIES INDEX

Features	705
Basic Models and Configuration	707
Specifications	709
Solenoid Valve, Air Piloted Valve Order Codes	711
Manifold Order Codes	712
Operating Principles and Symbols	713
Dimensions of Standard Type Solenoid Valve	714
Dimensions of Low Current Type Solenoid Valve	715
Dimensions of Manifold	716
Made to Order	719
Handling Instructions and Precautions	722

SOLENOID VALVES 300 SERIES

Solenoid Valves 300 Series

The series of optimum valves for operating mid-sized cylinders.

The 3-position solenoid valve required for intermediate stopping of air cylinders, and other series configurations for many different applications, are available. It is possible to provide a wide range of performance compatible with the required ability and grade of systems and devices.

AC Solenoid (Shading Coil Type) Features

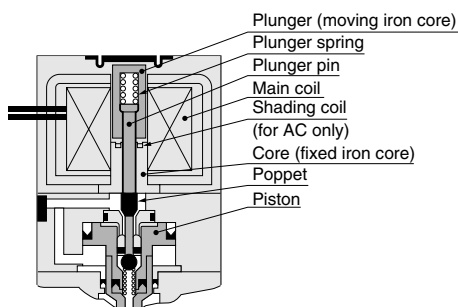

The shading coil type embeds a copper ring in its core (fixed iron core), and serves to suppress the attraction force pulsation caused by alternating current.

This is the same principle as the "flywheel diode type" with commutator, to suppress the attraction force pulsation.

The shading coil type has:

- Good response
 - A simple structure
 - No wiring polarity, and other features.
- However, it has the following disadvantages, which cause a reduction in reliability:
- Burning damage may occur
 - A humming noise may be generated
 - The shading coil may slip out

Koganei's newly developed shading coil type is a highly reliable method that has solved the above disadvantages, and we confidently recommend it.

Current waveforms during normal operation and abnormal operation

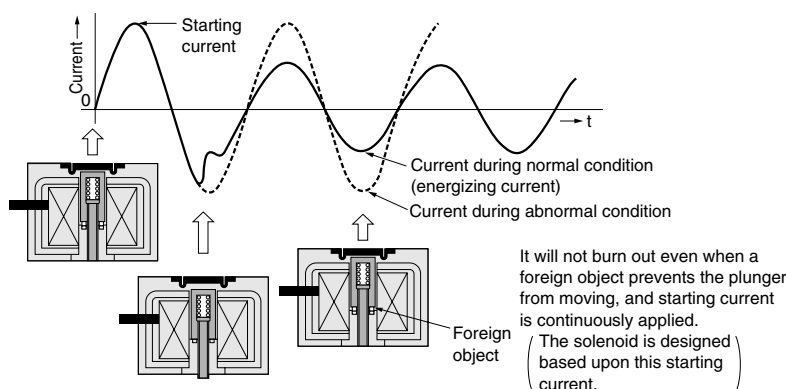

Shading coil function

Magnetic flux generated by the main coil inducing voltage to the shading coil, and the different phase magnetic flux generated by the electric current, work to suppress the pulse caused by AC power.

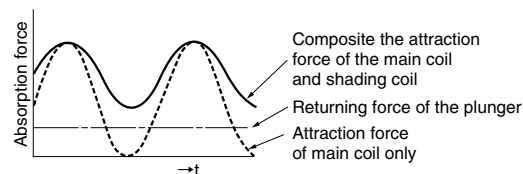

Standard type

- The product range includes internal pilot type 2-position and 3-position valves offering reliable operation with low current.
- The 2-position and 3-position valves can be mounted together on the 300 series manifold as with the single units.
- The AC solenoid uses the shading coil method to eliminate the burning and humming noise of solenoids.
- By using a dedicated speed controller, it enables quick and sharp operation stop.



Manifold

- Compatible with either single unit or manifold type valves (F, U, and L types)
- Product range (A and W types) offers piping outlet from the bottom of the manifold.
- Capable of combination mounting of solenoid valves and air piloted valves.

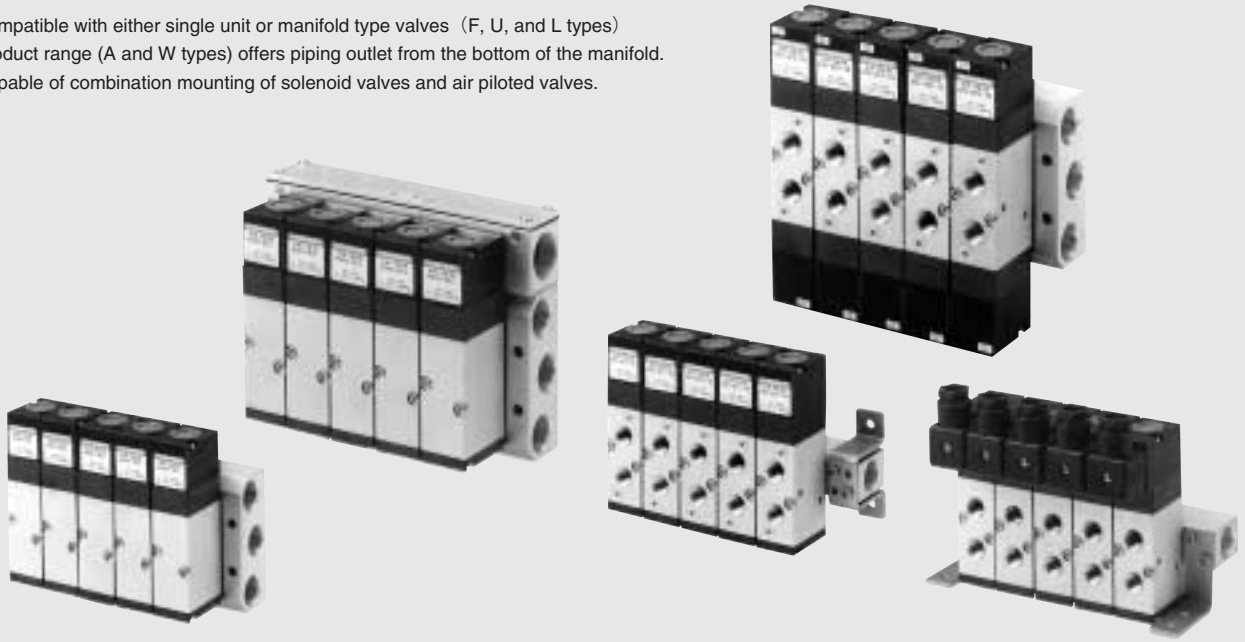









Low current type

- Power consumption is one-half of the standard type, offering reduction of initial costs and running costs.
- Basic construction is the same as the standard type, achieving high reliability and durability.
- Capable of direct drive, by using an IC and sequencer.



Single unit

		Pilot type solenoid valve			
		5-port, 2-position		5-port, 3-position	
Standard type	Single solenoid	Double solenoid		Closed center	Exhaust center
					
	300-4E1	300-4E2		303-4E2	303-4E2-13
Low current type	Single solenoid	Double solenoid		Closed center	Exhaust center
					
	300-4LE1	300-4LE2		303-4LE2	303-4LE2-13

Manifold

Manifold for mounting 5-port valves

FM□A — A type (all ports) manifold



FM□F — F type (1 (P), 3 (R2), 5 (R1)) manifold



FM□U — U type (1 (P), with U type bracket) manifold



FM□L — L type (1 (P), with L type bracket) manifold

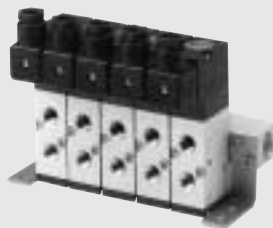

FM□W — W type (all ports, collective wiring) manifold



SOLENOID VALVES

300 SERIES

Basic Models and Valve Functions

Item	Basic model	Standard type			Low current type		
		300-4E1	300-4E2	303-4E2	300-4LE1	300-4LE2	303-4LE2
		A300-4E1	A300-4E2	A303-4E2	A300-4LE1	A300-4LE2	A303-4LE2
		W300-4E1	W300-4E2	—	—	—	—
Number of positions		2		3	2		3
Number of ports		5					
Valve function		Single solenoid	Double solenoid	Double solenoid	Single solenoid	Double solenoid	Double solenoid

Remark: For optional specifications and order codes, see p.711.

Specifications

Item	Basic model	Standard type			Low current type		
		300-4E1	300-4E2	303-4E2	300-4LE1	300-4LE2	303-4LE2
		A300-4E1	A300-4E2	A303-4E2	A300-4LE1	A300-4LE2	A303-4LE2
		W300-4E1	W300-4E2	—	—	—	—
Media		Air					
Operation type		Internal pilot type					
Effective area [Cv]	mm ²	25 [1.39]		20 [1.11]	25 [1.39]		20 [1.11]
Port size ^{Note}		Rc1/4 or Rc3/8 (3 (R2), 5 (R1) port: Rc1/4)					
Lubrication		Not required					
Operating pressure range MPa[kgf/cm ²] [psi.]		0.15~0.9 {1.5~9.2} [22~131]					
Proof pressure MPa[kgf/cm ²] [psi.]		1.35 [13.8] [196]					
Response time ms	DC24V	20/25 or below	20 or below	20 or below	20/25 or below	25 or below	25 or below
ON/OFF	AC100V, AC200V	20/25 or below	20 or below	20 or below	—	—	—
Maximum operating frequency Hz		5					
Minimum time to energize for self holding ms		—	50	—	—	50	—
Operating temperature range (atmosphere and media) °C [°F]		5~50 [41~122]					
Shock resistance m/s ² [G]		980.7 {100.0} (Axial direction 294.2 {30.0})		980.7 {100.0} (Axial direction 784.5{80.0})	980.7 {100.0} (Axial direction 294.2 {30.0})		980.7 {100.0} (Axial direction 784.5{80.0})
Mounting direction		Any					

Note: For details, see the port size.

Solenoid Specifications

Item	Rated voltage	Standard type				Low current type
		DC24V	AC100V		AC200V	DC24V
Type		—	Shading coil type			—
Operating voltage range V		21.6~26.4 (24±10%)	90~130 (100 ⁺³⁰ ₋₁₀ %)		180~260 (200 ⁺³⁰ ₋₁₀ %)	21.6~26.4 (24±10%)
Current ^{Note} (when rated voltage is applied)	Frequency Hz	—	50	60	50	60
	Starting mA(r.m.s)	—	106	94	51	46
	Energizing mA(r.m.s)	240 (5.8W) [252 (6.0W)]	55 [57]	44 [44]	27 [26]	22 [21]
Insulation resistance MΩ		Over 10				Over 10
Wiring type and lead wire length	Standard	Grommet type: 300mm [11.8in.]				Grommet type: 300mm [11.8in.]
	Optional	With terminal				With terminal
Color of lead wire		Red	Yellow		White	Red
LED indicator		Red	Yellow		Green	Red
Surge suppression	Standard	—				—
	Optional	—				Flywheel diode
	Made to order	The solenoid with LED indicator includes a surge absorber				—

Note: Figures in brackets [] are for solenoids with LED indicators.

Solenoid Valve Port Size

Basic model	Port specification	Port size
300-4E1, 300-4E2 303-4E2	Standard	Female thread Rc1/4
300-4LE1, 300-4LE2 303-4LE2	Optional	Female thread Rc3/8 (3 (R2), 5 (R1) port : Rc1/4)

Manifold Connection Port Size

Manifold model	Port	Location of piping connection	Port size
FM□A	1(P),3(R2),5(R1)	Manifold	Rc1/2
	4(A), 2(B)	Manifold	Rc1/4, Rc3/8
FM□F	1(P),3(R2),5(R1)	Manifold	Rc1/2
	4(A), 2(B)	Valve	Rc1/4, Rc3/8
FM□U	1(P)	Manifold	Rc1/2
FM□L	4(A),2(B),3(R2),5(R1)	Valve	Rc1/4, Rc3/8
FM□W	1(P),3(R2),5(R1)	Manifold	Rc1/2
	4(A), 2(B)	Manifold	Rc1/4, Rc3/8

Solenoid Valve Mass (Standard type)

Basic model	Mass g [oz.]
300-4E1	310 [10.93]
300-4E2	460 [16.23]
303-4E2	560 [19.75]
A300-4E1	320 [11.29]
A300-4E2	470 [16.58]
A303-4E2	570 [20.11]
W300-4E1	320 [11.29]
W300-4E2	470 [16.58]

(Low current type)

Basic model	Mass g [oz.]
300-4LE1	410 [14.46]
300-4LE2	640 [22.57]
303-4LE2	750 [26.46]
A300-4LE1	420 [14.81]
A300-4LE2	650 [22.93]
A303-4LE2	760 [26.81]

Manifold Mass

g [oz.]

Manifold model	Mass calculation of each unit (n=number of units)	Block-off plate
FM□A	$(180 \times n) + 200$ [(6.35 × n) + 7.05]	45 [1.59]
FM□F	$(190 \times n) + 200$ [(6.70 × n) + 7.05]	45 [1.59]
FM□U FM□L	$(40 \times n) + 200$ [(1.41 × n) + 7.05]	15 [0.53]
FM□W	$(210 \times n) + 250$ [(7.41 × n) + 8.82] When mounting E2 $(230 \times n) + 350$ [(8.11 × n) + 12.35]	45 [1.59]

Cylinder Operating Speed

Piping length 1000mm [39in.]

Maximum operating speed

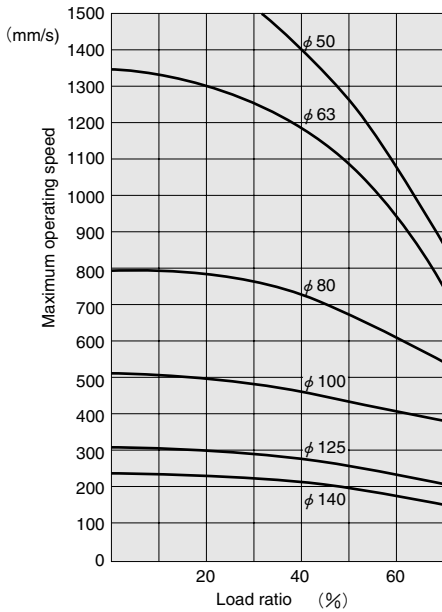

Piping length 5000mm [197in.]

Maximum operating speed

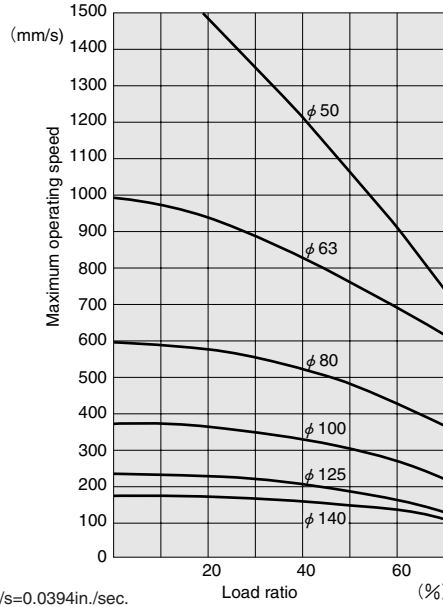

1mm/s=0.0394in./sec.

The graphs at left show the maximum operating speed for cylinders with piping lengths of 1000mm [39in.] or 5000mm [197in.]

To obtain the time required for the cylinder to complete 1 stroke, add the cylinder's delay time t_1 (time between energizing of solenoid valve and actual starting of cylinder), to the cylinder's max. speed operating time t_2 . When a cushioning is used, add the cushioning time t_3 to the above calculation.

Cylinder speed curve

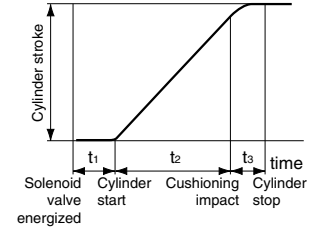

Measurement conditions

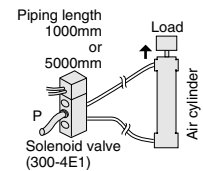

- Supply pressure: 0.5MPa [73psi.]
- Speed controller: None
- Piping and fitting inner diameter: φ8 [0.31in.]
- Cylinder stroke: 300mm [11.8in.]
- Load ratio = $\frac{\text{Load}}{\text{Cylinder theoretical thrust}}$ (%)

- Caution
- While the actual speed of an air cylinder in application depends on the load, cushion, and stopper configuration, in general, use a speed of 500mm/s [19.7in./sec.] or less.
- A built-in type speed controller can cause a reduction in operating speed of about 20%.

Cylinder delay time

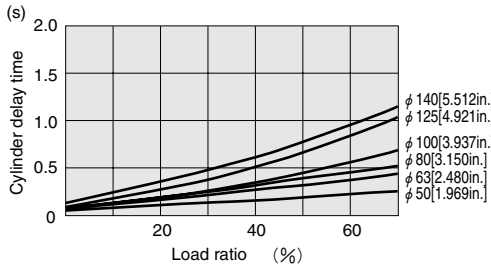

Cylinder delay time

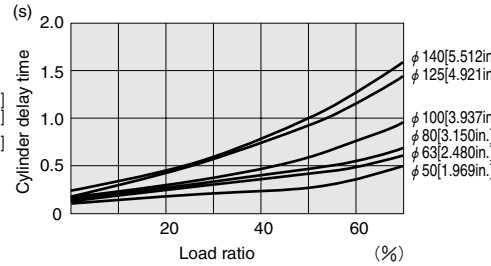

Flow Rate

300-4E1 300-4E2

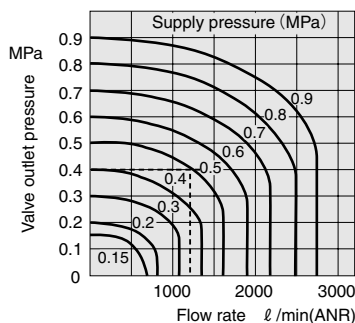

How to read the graph

When the supply pressure is 0.5MPa [73psi.] and the flow rate is 1250 l/min [44.1ft³/min.] (ANR), the valve outlet pressure becomes 0.4MPa [58psi.].

300-4LE1 300-4LE2

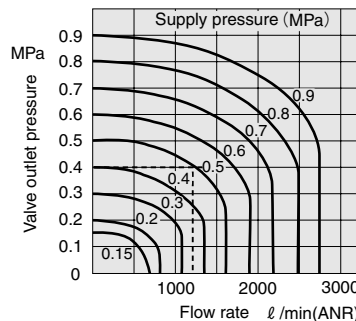

How to read the graph

When the supply pressure is 0.5MPa [73psi.] and the flow rate is 1250 l/min [44.1ft³/min.] (ANR), the valve outlet pressure becomes 0.4MPa [58psi.].

303-4E2 303-4LE2

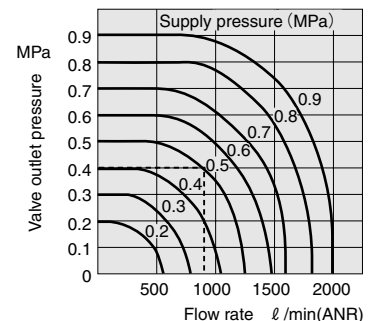







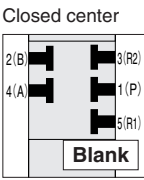
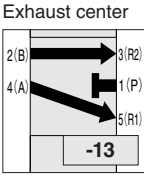
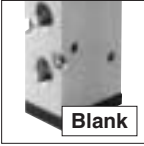

How to read the graph

When the supply pressure is 0.5MPa [73psi.] and the flow rate is 900 l/min [31.8ft³/min.] (ANR), the valve outlet pressure becomes 0.4MPa [58psi.].

1MPa=145psi. 1 l/min.=0.0353ft³/min.

Solenoid Valve, Air Piloted Valve Order Codes (Standard Type, Low Current Type)

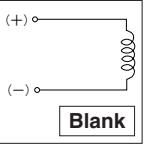
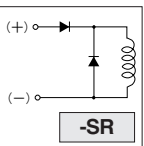
		3-position valve Valve function	Port size	Mounting base	Speed controller	Indicator	Wiring type	Flywheel diode		
		<p>Closed center</p>  <p>Blank</p> <p>Exhaust center</p>  <p>-13</p>	<p>Blank: Rc1/4</p> <p>-03: Rc3/8</p> <p>(3 (R2), 5 (R1) ports: Rc1/4)</p>	<p>Without mounting base</p>  <p>Blank</p> <p>With mounting base</p>  <p>-21</p> <p>For single solenoid only</p>	<p>Without speed controller</p>  <p>Blank</p> <p>With speed controller</p>  <p>-70</p>	<p>Without indicator</p>  <p>Blank</p> <p>With indicator</p>  <p>-IN</p>	<p>Grommet type</p>  <p>Blank</p> <p>With terminal</p>  <p>-T</p>	<p>Without flywheel diode</p>  <p>Blank</p> <p>With flywheel diode</p>  <p>-SR</p>	Basic model	Voltage
For F, U, L type manifolds	Single solenoid	300-4E1								AC100V AC200V DC24V
	2-position double solenoid	300-4E2								
	3-position double solenoid	303-4E2	-13							
For A type manifold	Single solenoid	A300-4E1								AC100V AC200V DC24V
	2-position double solenoid	A300-4E2								
	3-position double solenoid	A303-4E2	-13							
For W type manifold	Single solenoid	W300-4E1								AC100V AC200V DC24V
	2-position double solenoid	W300-4E2								
For F, U, L type manifolds (low current type)	Single solenoid	300-4LE1								DC24V
	2-position double solenoid	300-4LE2								
	3-position double solenoid	303-4LE2	-13							
	Single solenoid	A300-4LE1								
	2-position double solenoid	A300-4LE2								
	3-position double solenoid	A303-4LE2	-13							
Direct piping air piloted valve (made to order)	Single pilot	300-4A								-IN
	Double pilot	300-4A2								
Base piping air piloted valve (made to order)	Single pilot	A300-4A								-IN
	Double pilot	A300-4A2								

● Solenoid with flywheel diode is surge suppression type solenoid.

Options

Mounting base



● For direct piping
● Not available for double solenoid

Speed controller

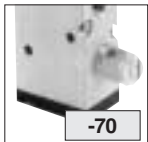

● For direct piping

Indicator

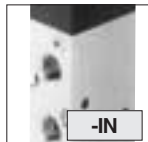

Wiring type



● With terminal

Flywheel diode

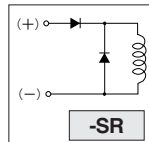

Manifold Order Codes

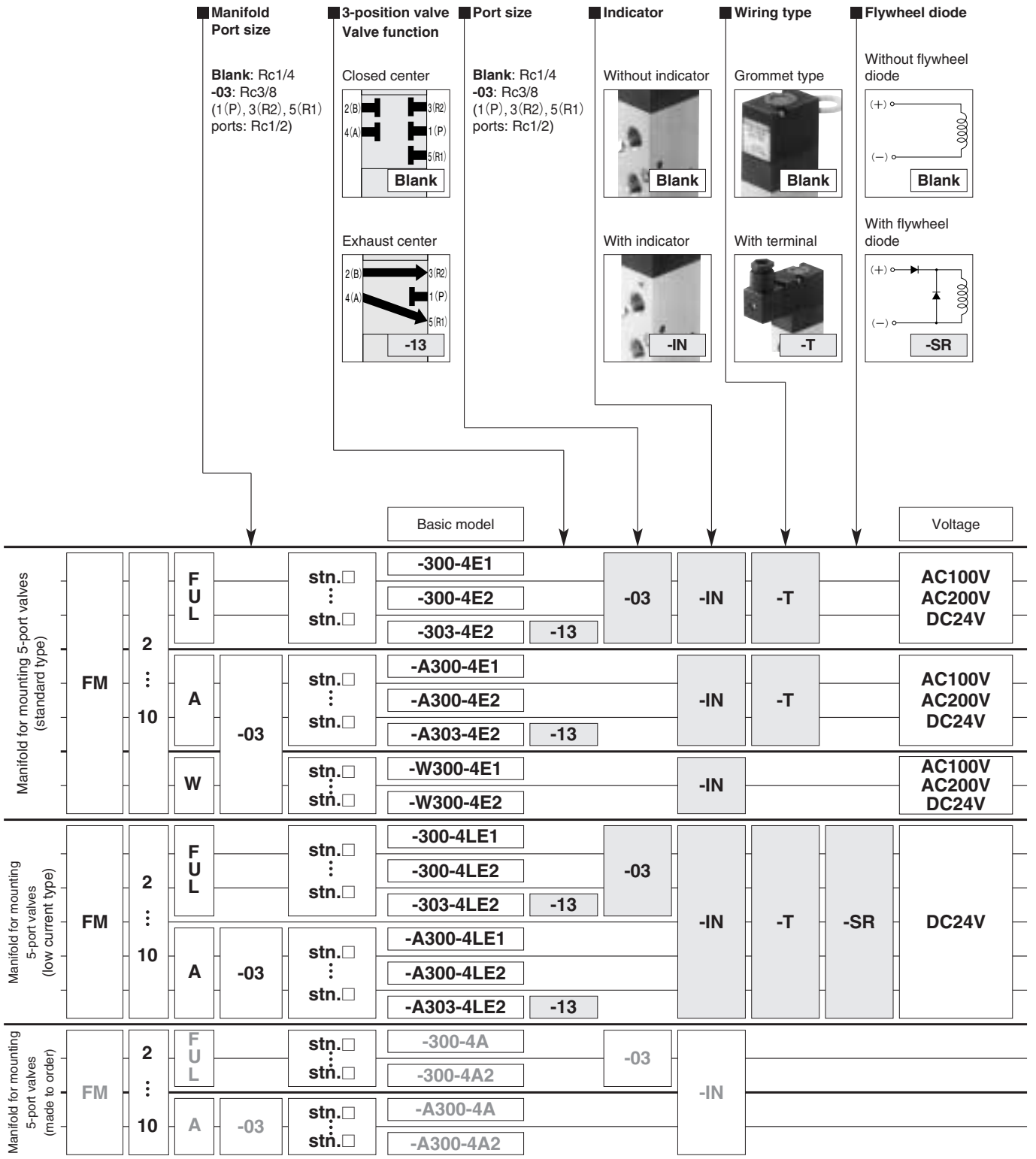

SOLENOID VALVES 300 SERIES

● Valve mounting location from the left-hand side when facing the 4(A), 2(B) ports.

● Specify the valve type for each station.

● Enter -BP when closing a station with a block-off plate without mounting a valve.

Made to Order

Air piloted valves
300 series

Grommet type
with LED indicator

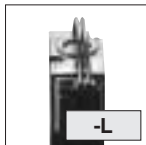

- 5-port, 2-position
- Single pilot
- Double pilot

Operating Principles and Symbols

5-port, 2-position

300-4E1

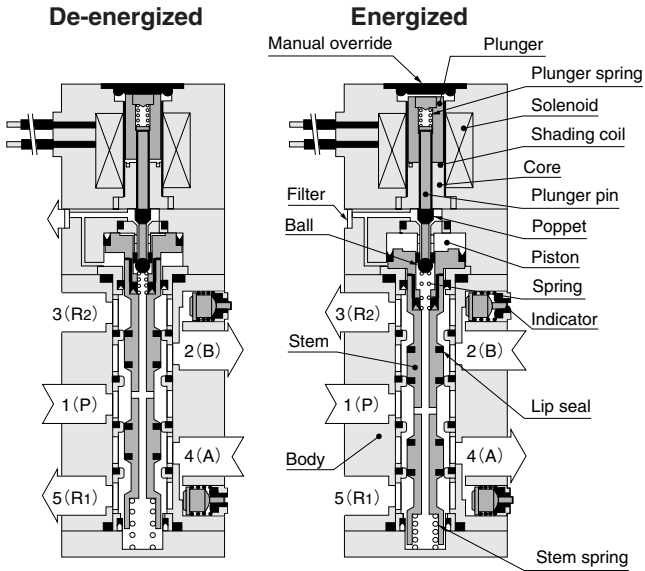

Note: Schematic diagram shows unit with indicator.

Single solenoid

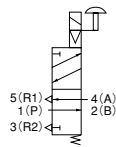

Double solenoid

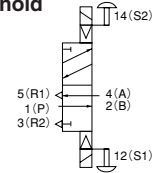

300-4E2

(De-energized condition after energizing solenoid 14(S2))

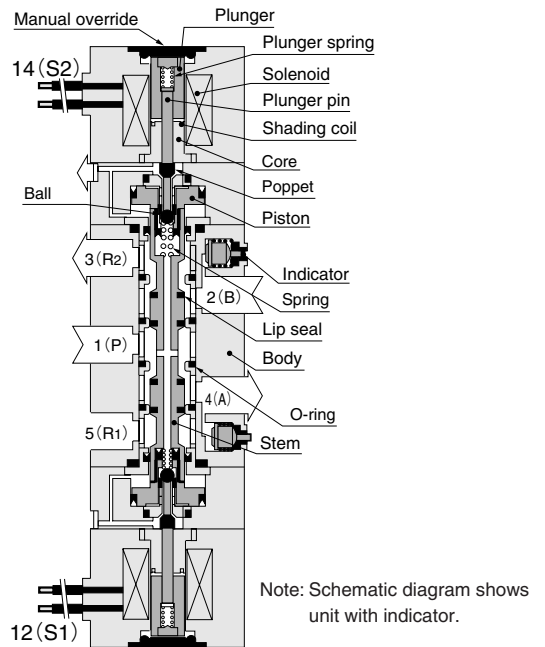

Note: Schematic diagram shows unit with indicator.

5-port, 3-position

Closed center

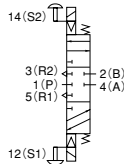

303-4E2

De-energized

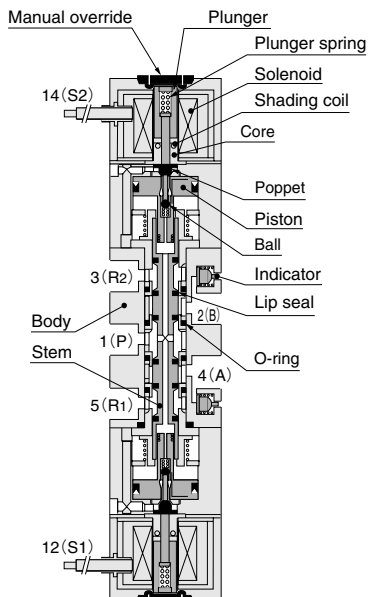

Exhaust center

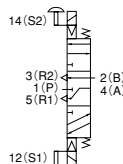

303-4E2-13

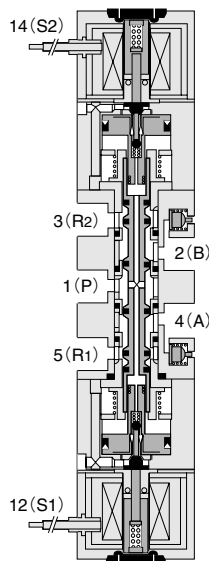

Major Parts and Materials

Parts		Materials
Valve	Body	Aluminum alloy
	Stem	(anodized)
	Plunger	
	Plunger pin	Stainless steel
	Stem spring	
	Lip seal	Synthetic rubber
	Seal	
	O-ring	
	Insert	Aluminum alloy (anodized)
	Base	Mild steel (zinc plated)
Manifold	Body	Aluminum alloy (anodized)
	Block-off plate	Mild steel (zinc plated)
	Bracket	

Dimensions of Standard Type Solenoid Valve (mm)

300-4E1

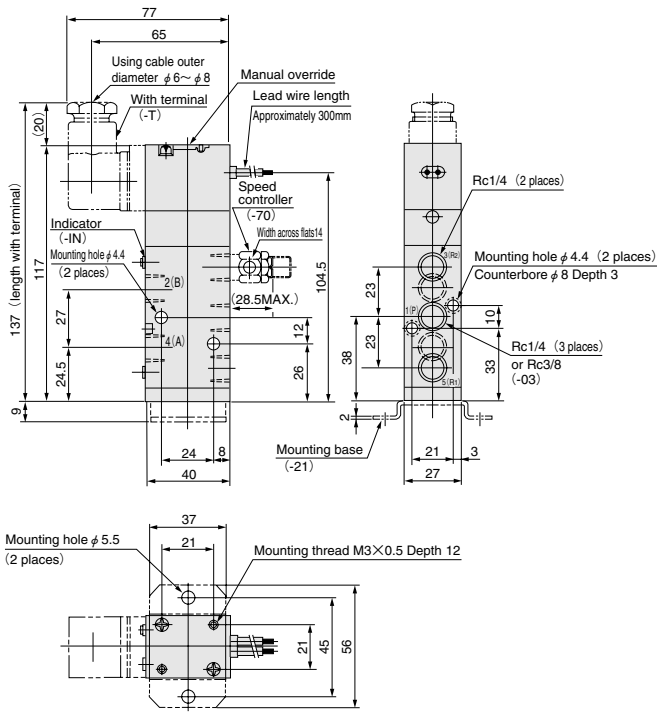

300-4E2

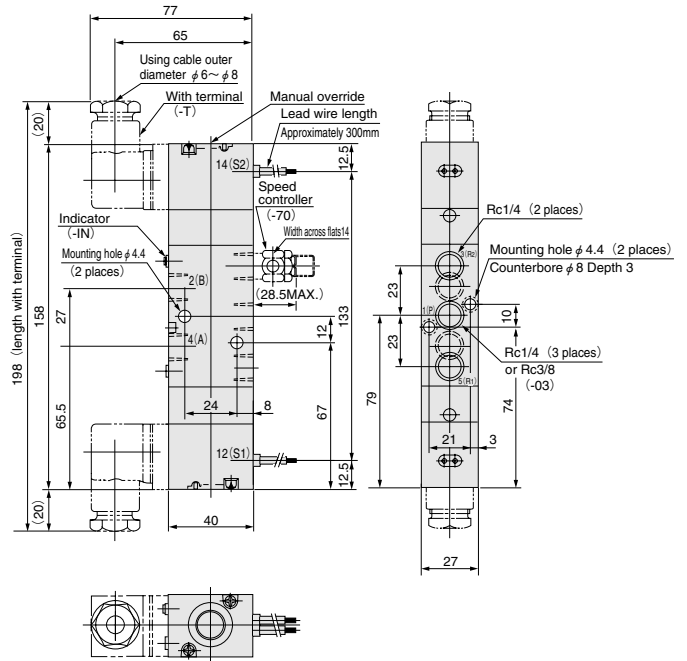

303-4E2

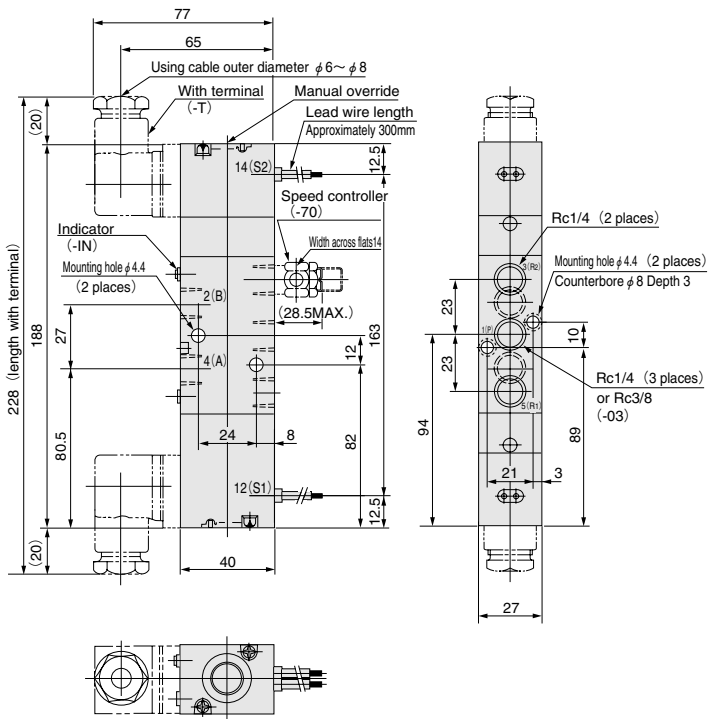

Dimensions of Low Current Type Solenoid Valve (mm)

300-4LE1

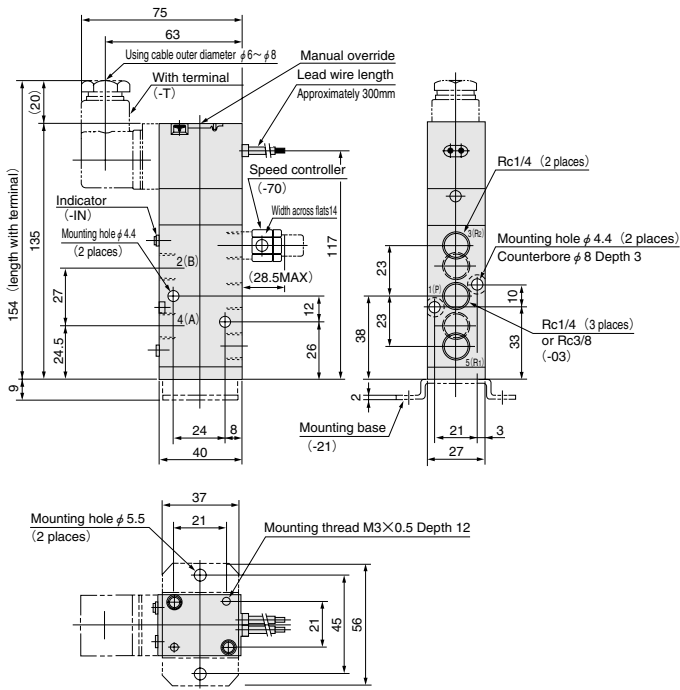

300-4LE2

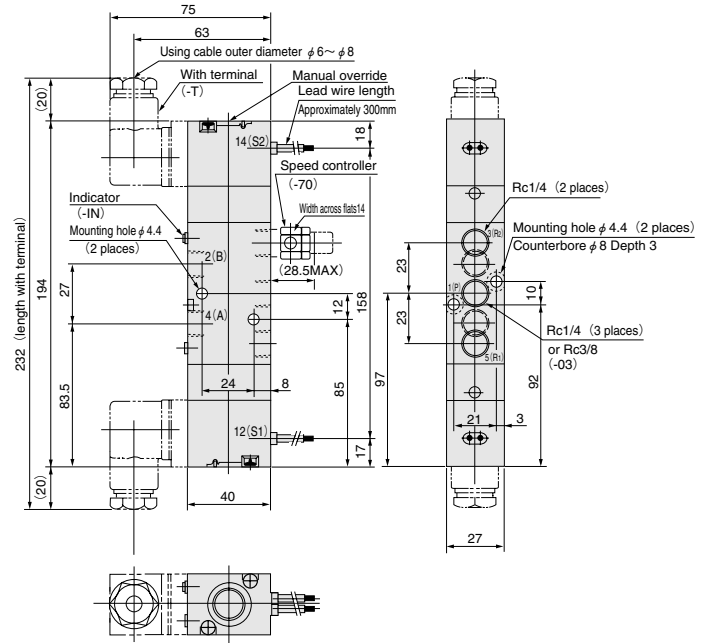

303-4LE2

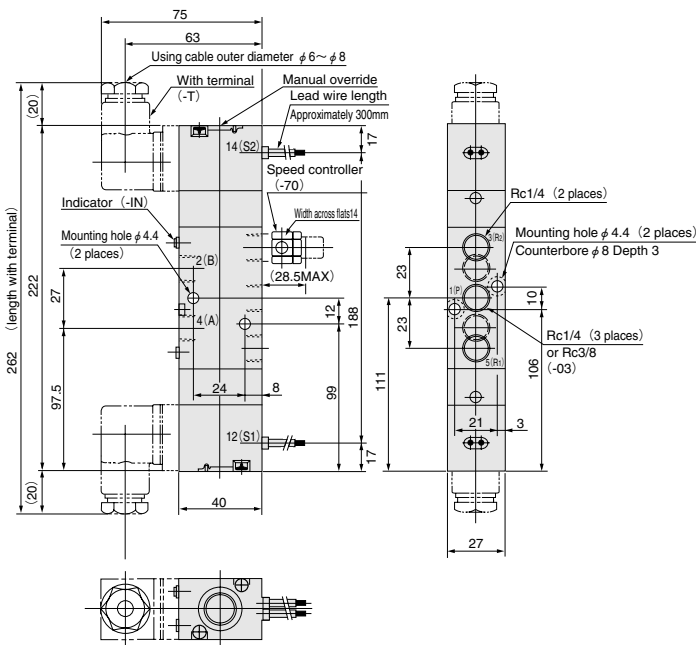

Dimensions of Manifold (mm)

A type

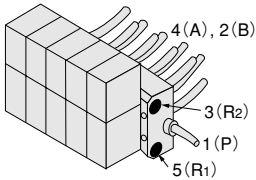

Maintenance-oriented construction allows replacement of valves without removing piping.

- The 4(A) and 2(B) ports are located on the bottom surface of the base, to allow direct piping from the inside of a control box to the outside.
- Enables collective piping of the 3(R2), 5(R1) ports.
- The valves that can be mounted are the ones for the A type manifold only.

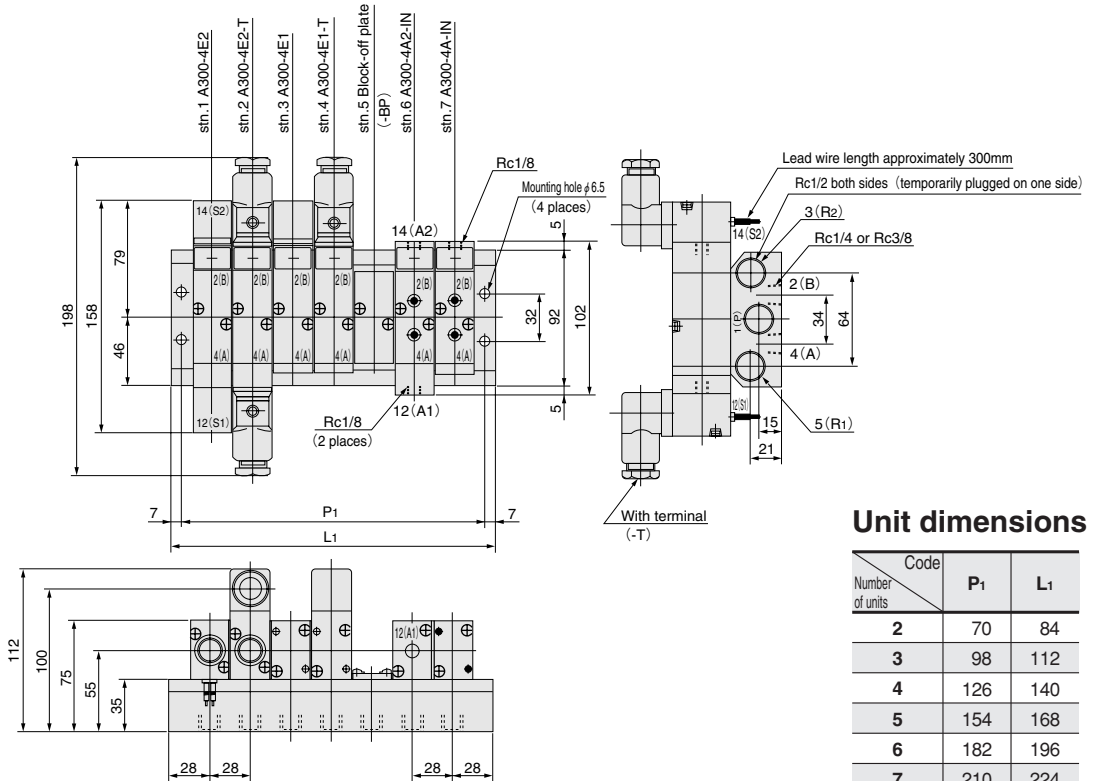

Unit dimensions

Code	P ₁	L ₁
2	70	84
3	98	112
4	126	140
5	154	168
6	182	196
7	210	224
8	238	252
9	266	280
10	294	308

F type

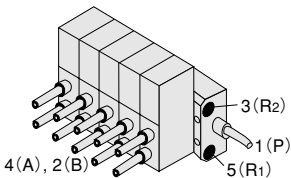

Can be directly connected to the 4(A) and 2(B) ports of the valves, and the valves are the same as the single unit valves.

- Enables collective piping of the 3(R2), 5(R1) ports.

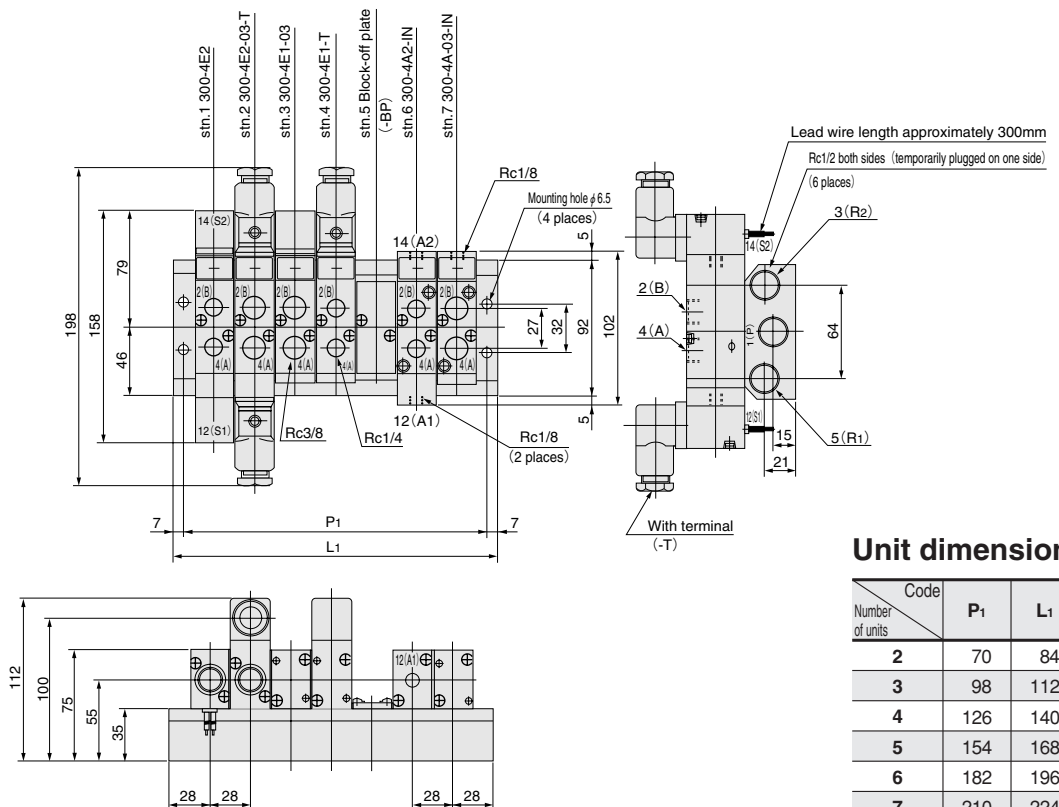

Unit dimensions

Code	P ₁	L ₁
2	70	84
3	98	112
4	126	140
5	154	168
6	182	196
7	210	224
8	238	252
9	266	280
10	294	308

U Type

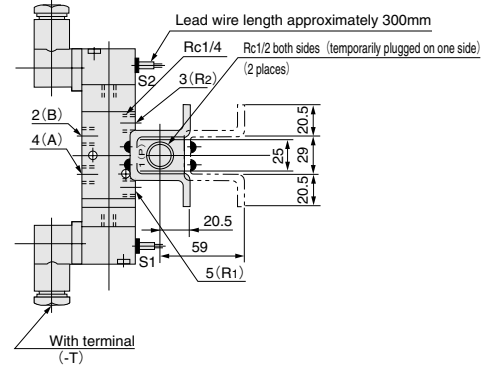
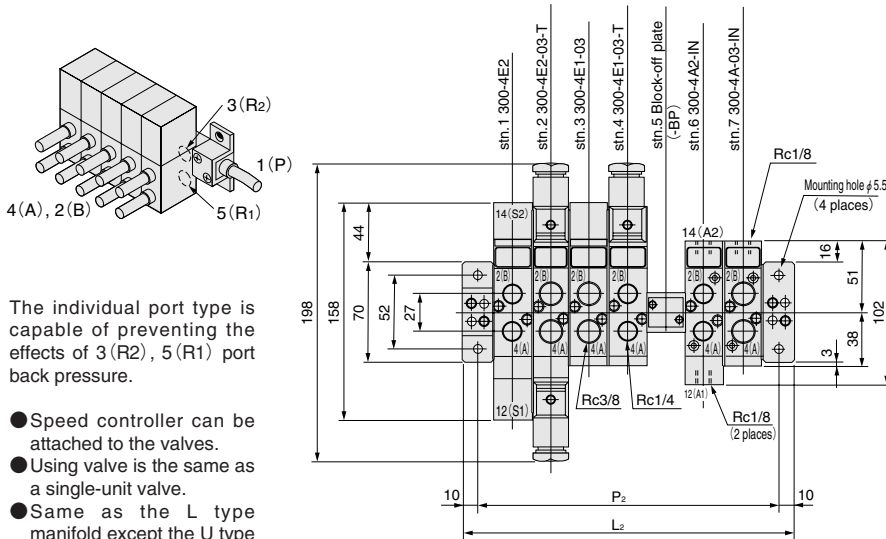

The individual port type is capable of preventing the effects of 3 (R2), 5 (R1) port back pressure.

- Speed controller can be attached to the valves.
- Using valve is the same as a single-unit valve.
- Same as the L type manifold except the U type brackets are included.
- For the muffler on the 3 (R2), 5 (R1) ports, use the KM-22 type.

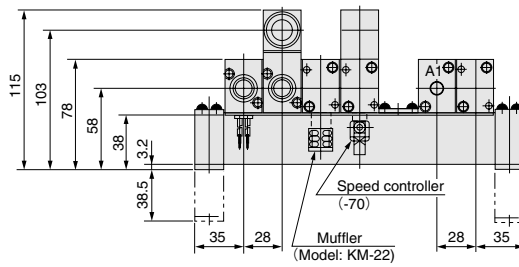

Unit dimensions

Model	P ₂	L ₂
2	78	98
3	106	126
4	134	154
5	162	182
6	190	210
7	218	238
8	246	266
9	274	294
10	302	322

L Type

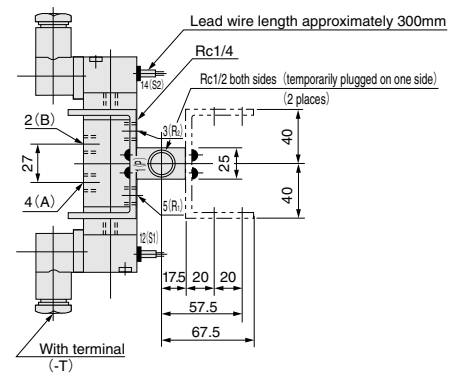
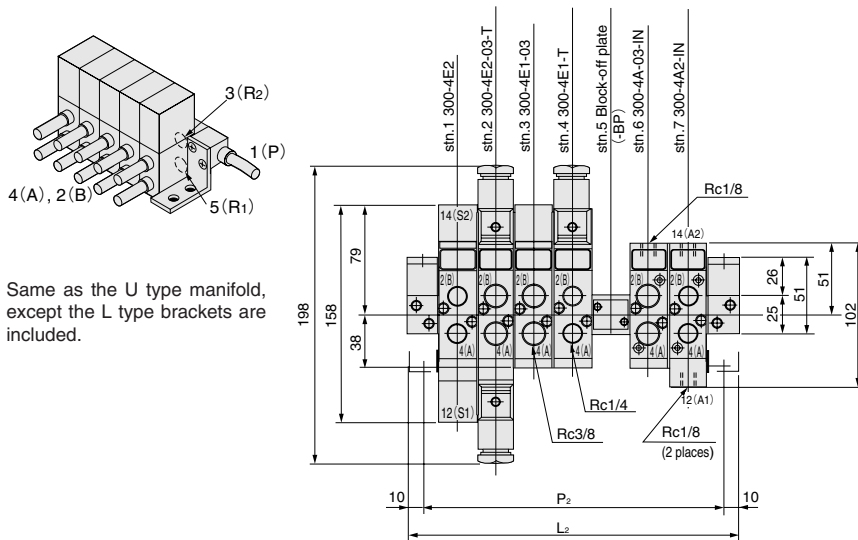

Same as the U type manifold, except the L type brackets are included.

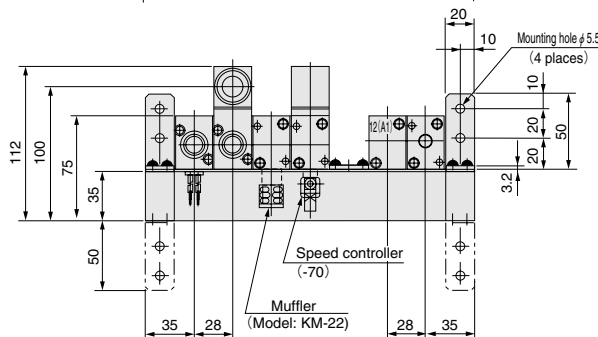

Unit dimensions

Model	P ₂	L ₂
2	78	98
3	106	126
4	134	154
5	162	182
6	190	210
7	218	238
8	246	266
9	274	294
10	302	322

W Type

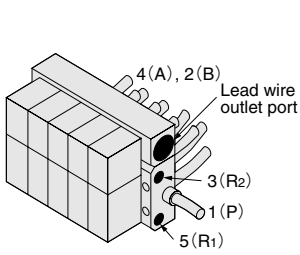

It is a collective wiring type. Except that, it is the same as the A type manifold.

- Mountable valve types are for the W type manifold only. It is different from the A type valve for manifold use; that is, connectors are included in the lead wire, and an O-ring for the seal of the lead wire is also included.

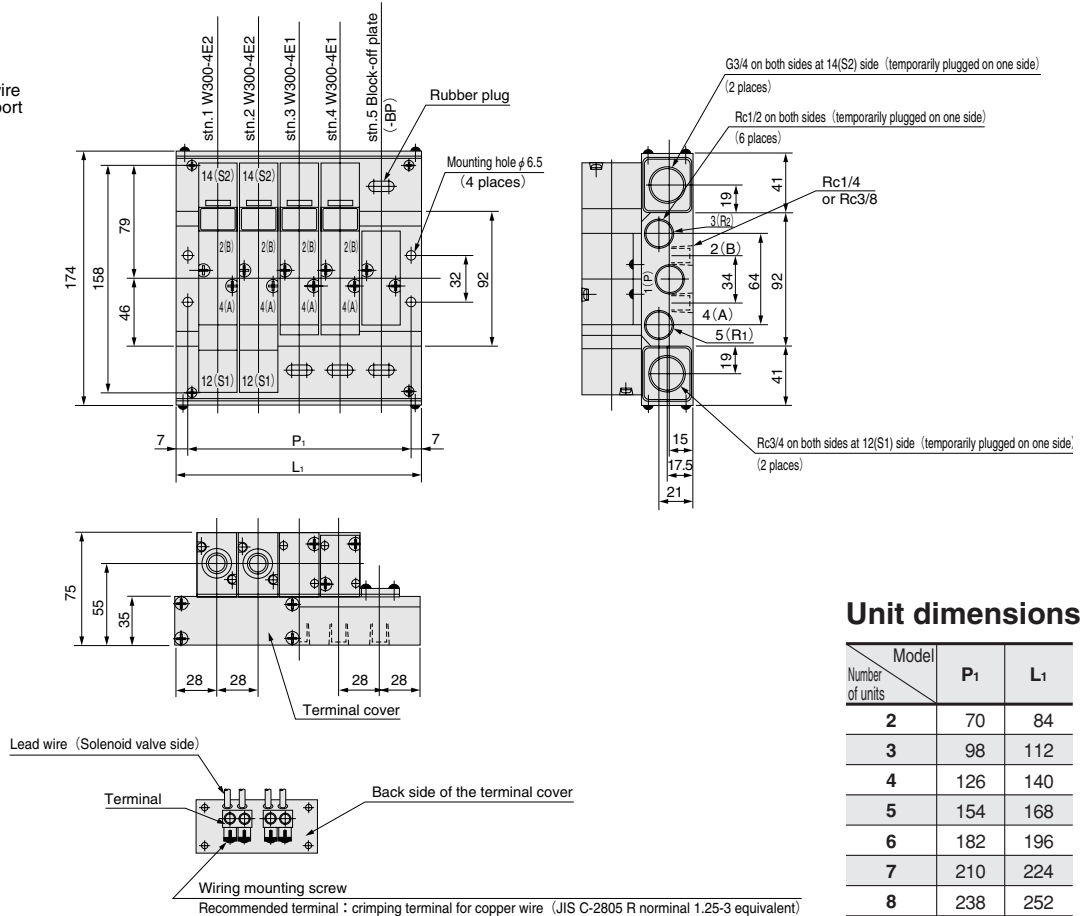

Unit dimensions

Number of units	Model	
	P ₁	L ₁
2	70	84
3	98	112
4	126	140
5	154	168
6	182	196
7	210	224
8	238	252
9	266	280
10	294	308

SOLENOID VALVES 300 SERIES

Option

(For U type, L type manifolds)

KM-22 Muffler

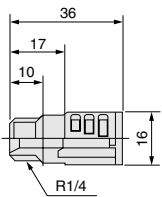

- Materials: Plastic
- Mass: 4.5g
- Effective area: 21mm²
- Noise suppressing effect: 18dB

Made to Order

Air piloted valves 300 series

- The optimum air valves for master valves or pilot valves for all-pneumatic control.



Basic Models and Valve Functions

Item	Basic model	300-4A	300-4A2
		A300-4A	A300-4A2
Number of positions		2	
Number of ports		5	
Valve function		Single pilot	Double pilot

Remark: For optional specifications and order codes, see p.711.

Specifications

Item	Basic model	300-4A	300-4A2
		A300-4A	A300-4A2
Media		Air	
Effective area [Cv] ^{Note 1} mm ²		25 [1.39]	
Port size ^{Note 2}	Main	Rc1/4 or Rc3/8 (3(R2), 5(R1) ports: Rc1/4)	
	Pilot	Rc1/8	
Lubrication		Not required	
Operating pressure range MPa [kgf/cm ²] [psi.]	Main	0.1~0.9 {1.0~9.2} [15~131]	
	Pilot	See the table "Minimum Pilot Pressure"	
Proof pressure MPa [kgf/cm ²] [psi.]		1.35 [13.8] [196]	
Operating temperature range (atmosphere and media) °C[°F]		5~50 [41~122]	
Shock resistance m/s ² [G]	Lateral direction	1373.0 [140.0]	
	Vertical direction	—	
Mounting direction		Any	

- Notes: 1. For details, see the effective area.
2. For details, see the port size.

Effective Area [Cv]

Basic model	Standard (Single valve unit)	mm ²
300-4A 300-4A2		25 [1.39]
A300-4A A300-4A2		25 [1.39]

Air piloted Valve Connection Port

Basic model	Port size	
300-4A	Main	Rc1/4, Rc3/8 (3(R2), 5(R1) ports: Rc1/4)
	Pilot	Rc1/8
300-4A2	Main	Rc1/4, Rc3/8 (3(R2), 5(R1) ports: Rc1/4)
	Pilot	Rc1/8

Manifold Connection Port Size

Manifold model	Port	Location of piping connection	Port size
FM□A	1(P),4(A),2(B),3(R2),5(R1)	Manifold	Rc1/4, Rc3/8
FM□F	1(P), 3(R2), 5(R1)	Manifold	Rc1/4, Rc3/8
	4(A), 2(B)	Valve	Rc1/4
FM□U	1(P)	Manifold	Rc1/4, Rc3/8
FM□L	4(A),2(B),3(R2),5(R1)	Valve	Rc1/4
FM□W	1(P),4(A),2(B),3(R2),5(R1)	Manifold	Rc1/4, Rc3/8

Air piloted Valve Mass

Basic model	Mass	g [oz.]
300-4A		200 [7.05]
300-4A2		240 [8.47]

Manifold Mass

Manifold model	Mass calculation of each unit (n=Number of units)	Block-off plate	g [oz.]
300FM□A	(180×n)+200 [(6.35×n)+7.05]	45 [1.59]	
300FM□F	(190×n)+200 [(6.70×n)+7.05]	45 [1.59]	
300FM□U 300FM□L	(40×n)+200 [(1.41×n)+7.05]	15 [0.53]	

Minimum Pilot Pressure

Main pressure Model	MPa {kgf/cm ² } [psi.]				
	0.1 {1.0} [15]	0.3 {3.1} [44]	0.5 {5.1} [73]	0.7 {7.1} [102]	0.9 {9.2} [131]
300-4A	0.15 {1.5} [22]	0.2 {2.0} [29]	0.25 {2.5} [36]	0.33 {3.4} [48]	0.4 {4.1} [58]
300-4A2	0.1 {1.0} [15]	0.12 {1.2} [17]		0.15 {1.5} [22]	

Time Required for Switching

Valve model	Switching valve	Operation	Pilot line length ℓ m [ft.]				
			2 [6.6]	6 [19.7]	10 [32.8]	50 [164]	100 [328]
300-4A	3-port valve (125P)	ON	0.06	0.10	0.17	1.00	2.20
		OFF	0.08	0.19	0.33	2.65	6.00
300-4A2	4-port valve (125-4E1)	ON	0.06	0.12	0.20	1.20	2.80
		OFF	0.06	0.12	0.20	1.20	2.80
	3-port valves (125P)	ON	0.04	0.07	0.09	0.60	1.30
		OFF	0.04	0.07	0.09	0.60	1.30

Measurement conditions Air pressure (both main and pilot): 0.5MPa [73psi.]
Tube inner diameter: 4mm [0.16in.]

Flow Rate

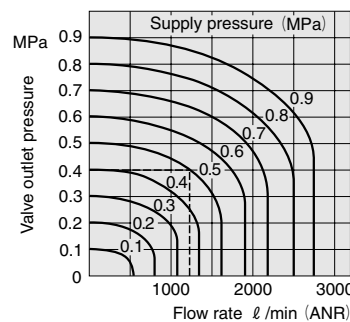

1MPa=145psi. 1 ℓ/min.=0.0353ft³/min.

How to read the graph

When the supply pressure is 0.5MPa [73psi.] and the flow rate is 1250 ℓ/min [44.1ft³/min.] (ANR), the valve outlet pressure becomes 0.4MPa [58psi.].

Major Parts and Materials

Parts	Materials
Body	Aluminum alloy (anodized)
Stem	
Stem spring	Stainless steel
Lip seal	Synthetic rubber
Seal	
O-ring	
Insert	Aluminum alloy (anodized)
Base	Mild steel (zinc plated)

Operating Principles and Symbols

5-port, 2-position

Single pilot

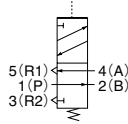

Double pilot

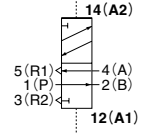

300-4A

Normal condition

Actuated condition

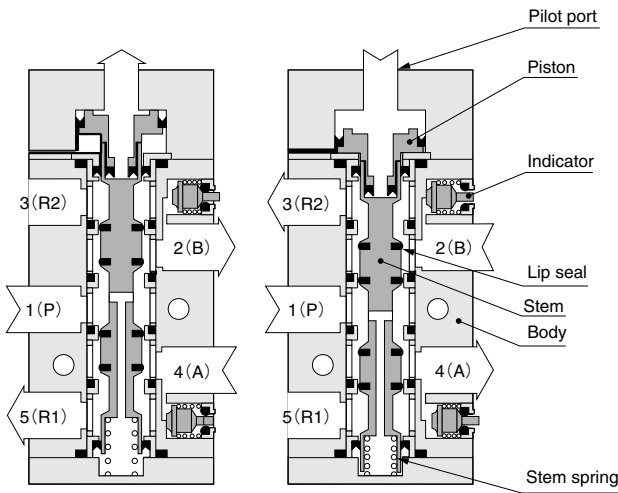

Note: Schematic diagram shows unit with indicator.

300-4A2

Holding condition (Released condition after piloted on 14(A2))

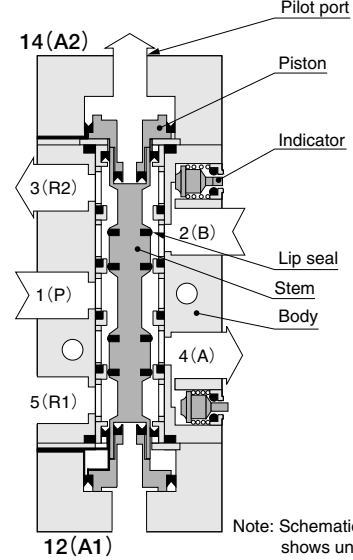

Note: Schematic diagram shows unit with indicator.

Dimensions of Air Piloted Valve (mm)

300-4A

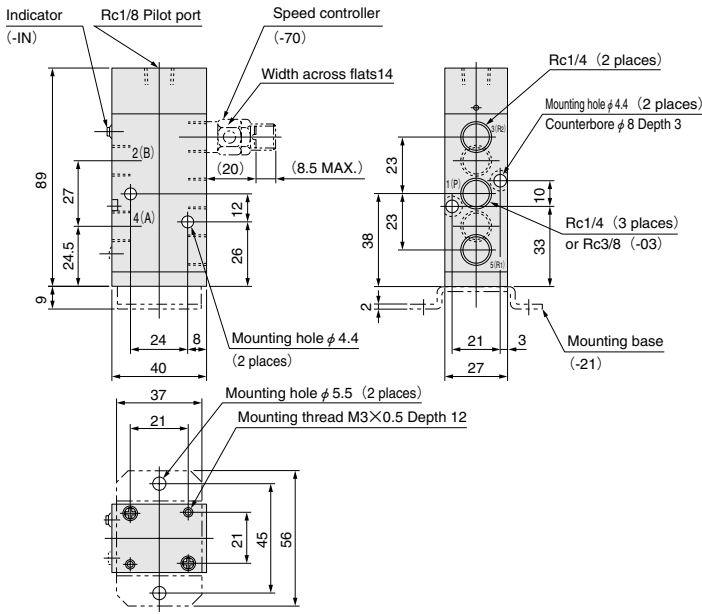

300-4A2

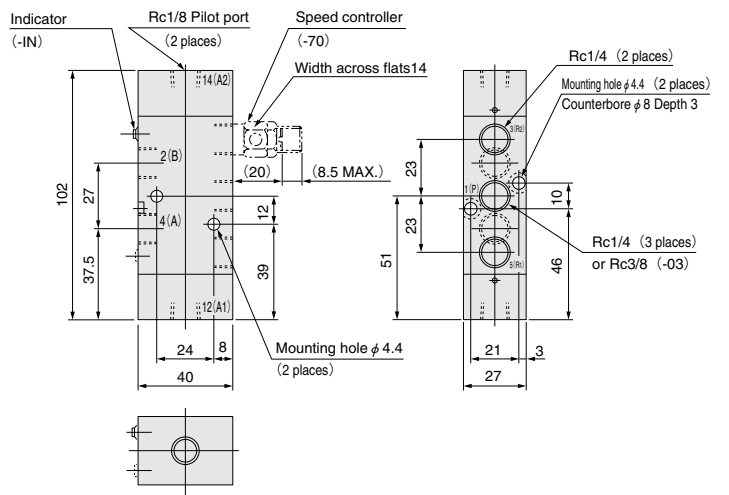

LED indicator



Integrated LED indicator for confirmation of operation in the compact cover offers a clear monoblock look.

● When ordering, enter -L before the voltage code.

AC100V AC200V

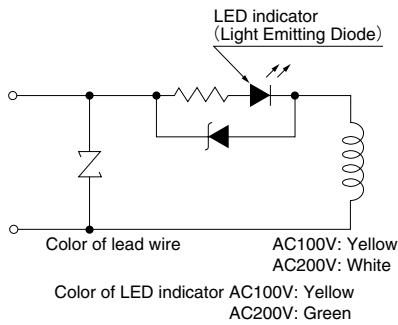

DC24V

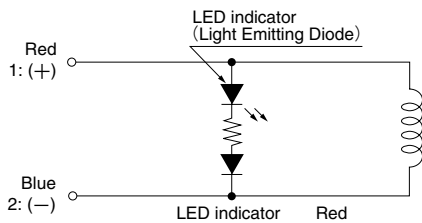

Handling Instructions and Precautions



Manual override

Non-locking type

To operate the manual override, press it all the way down. For the single solenoid, the valve works the same as when in the energized state as long as the manual override is pushed down, and returns to the normal position upon release.

For the double solenoid, pressing the manual override on the 12(S1) side switches the state of the 12(S1) to enter the energized position, and the unit remains in that state even after the manual override is released. To return it to the normal position, operate the manual override on the 14(S2) side. This is the same for the solenoid 14(S2).

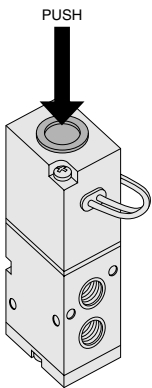

※ Illustration shows the 200 series.

Caution: The 300 series valves are internal pilot type solenoid valves. As a result, the manual override cannot switch the main valve without air supplied from the 1(P) port.

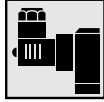

Terminal connector

Wiring instructions

- Remove the terminal cover mounting screw ②, pull out and lift off the terminal cover ③ from the solenoid body ①.
- Insert the cable from the wiring port on the terminal cover ③, and connect the cable to the terminal ④ of the solenoid body ①.
- While pulling the cable, position the terminal cover ③ on the solenoid body ①, and use the terminal cover mounting screw ② to secure the terminal cover on the solenoid body ① in place.

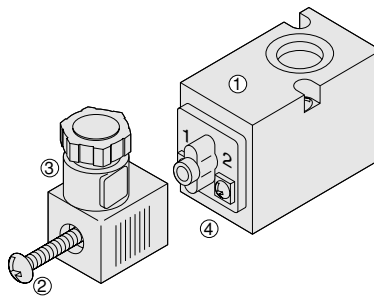

For DC 1: (+)
2: (-)

