

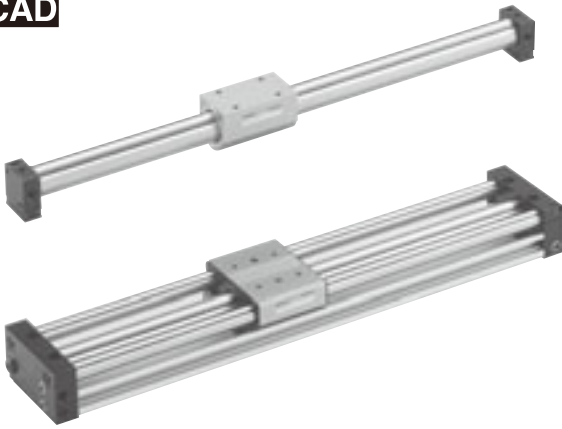

CAD drawing data catalog
is available.



KOGANEI

ACTUATORS GENERAL CATALOG

MAGNET TYPE RODLESS CYLINDERS MRC, MRG SERIES CONTENTS

Features	1159
MRC Series	
Specifications	1161
Order Codes	1162
Inner Construction, Major Parts and Materials	1163
Dimensions	1164
MRG Series	
Specifications	1166
Order Codes	1168
Inner Construction, Major Parts and Materials	1169
Dimensions	1170
Sensor Switches	1172
Handling Instructions and Precautions	1175

MAGNET TYPE RODLESS CYLINDERS MRC, MRG SERIES



Caution

Before use, be sure to read the "Safety Precautions" on p. 57.

Magnet Type Rodless Cylinders

MRC, MRG

We promise strong retaining force and stable operation because of the neodymium rare earth magnet being used.

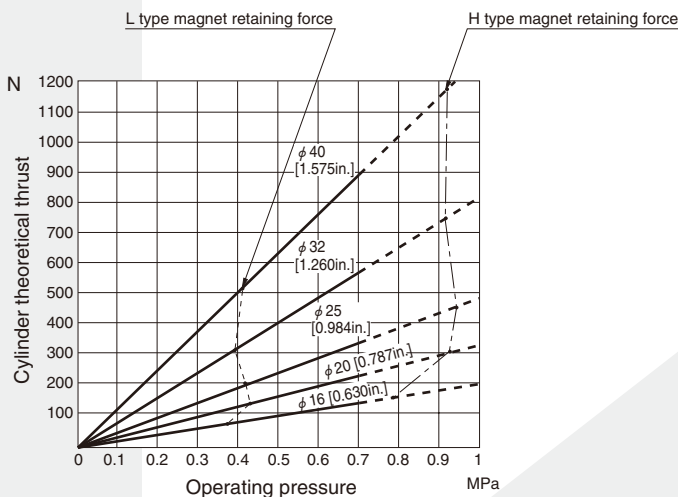
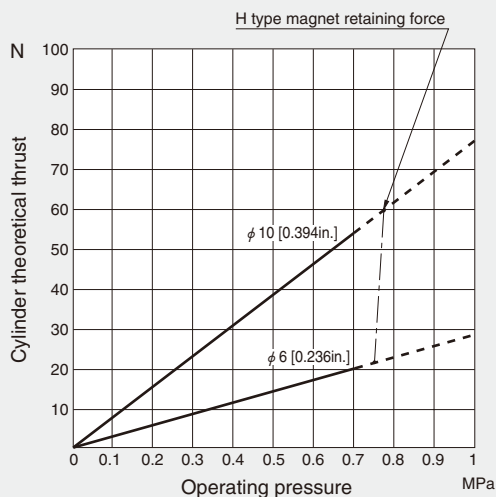

1N = 0.2248lbf., 1MPa = 145psi.

MRC <Basic type>

1. The installation is easy.

The end cover can be installed directly as the block type, without using a mounting bracket.

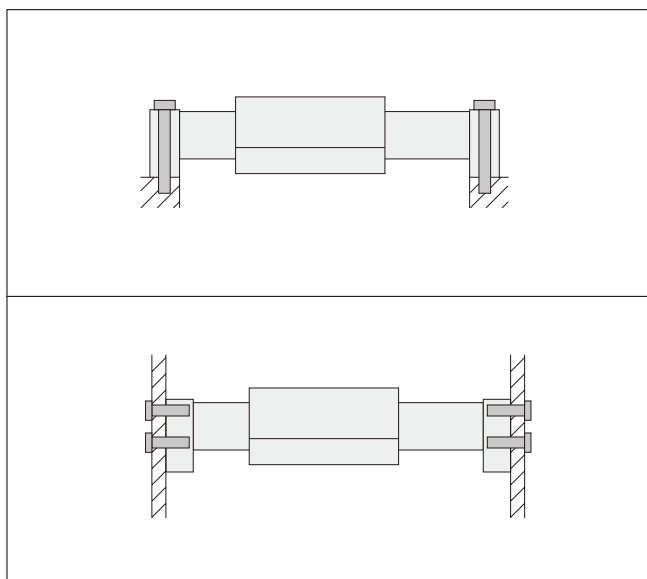

2. The sensor switch can be used.

The end of the stroke position can be easily detected in the H types by just installing a sensor switch, except for bore size 6mm [0.236in.].

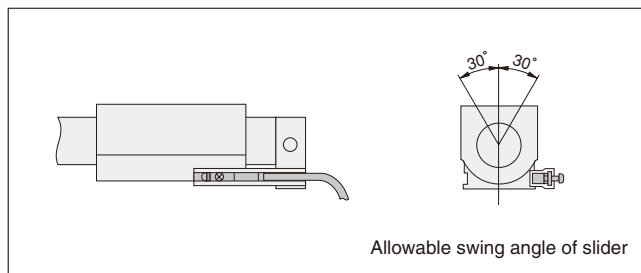

3. Installation of M mount

M mount which eliminates excessive load by moment is optional. When M mount is used, compensating misalignment and smooth operation becomes possible.

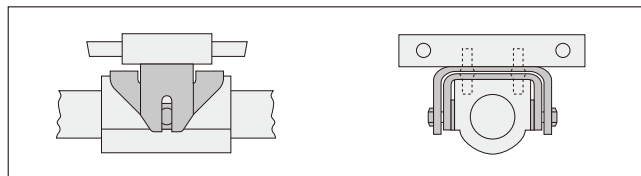

Wide product range saves space and simplifies operations

Bore size : $\phi 6$ [0.236in.], $\phi 10$ [0.394in.], $\phi 16$ [0.630in.], $\phi 20$ [0.787in.],
 $\phi 25$ [0.984in.], $\phi 32$ [1.260in.], and $\phi 40$ [1.575in.]



MRG <With guide>

1. Durability is increased, and guides have been used to enable heavy load capacity.

The load, which applied to the cylinder tube, is distributed to 2 guide shafts. A heavy load capacity (490.3N [110.2lbf.] or less for $\phi 40$ [1.575in.]) and a large allowable moment are obtained.



2. The stroke can be finely adjusted.

The stroke can be finely adjusted with the stroke adjusting bolt within the range of +1~-6mm [+0.039~-0.236in.] for one side.



3. It is possible to install a double rod type shock absorber.

A double rod type shock absorber which can be installed in the slider is optional. With multi orifice type operation, which needs no adjustment, the shock is smoothly absorbed.



4. Concentrated piping on one side

Concentrated piping on one side is possible on the end surface or the side as shown in the diagram to the right. Moreover, the piping location can be selected according to installation requirements because there are many connection ports.

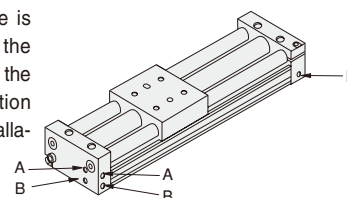

5. Sensor switches can be used.

The magnet for the sensor switch and the mounting rail are standard equipment. Many kinds of small sized sensor switches can be attached.





Specifications

Bore size mm [in.]		6 [0.236]	10 [0.394]	16 [0.630]	20 [0.787]	25 [0.984]	32 [1.260]	40 [1.575]
Item								
Operation type		Double acting type						
Media		Air						
Operating pressure range MPa [psi.]	H type	0.18~0.7 [26~102]			0.15~0.7 [22~102]			
	L type	—			0.1~0.34 [15~49]			
Proof pressure	MPa [psi.]	1.03 [149]						
Operating temperature range	°C [°F]	0~60 [32~140]						
Operating speed range	mm/s [in./sec.]	100~400 [3.9~15.7]						
Cushion		Rubber bumper						
Lubrication		Not required						
Stroke tolerance mm [in.]	1000 or less	+1.5 [+0.059]			0 [0]			
	1001~1500	+2.0 [+0.079]			0 [0]			
Port size		M5×0.8			Rc1/8		Rc1/4	

Remark: For details of the sensor switches, see p.1544.

Symbol

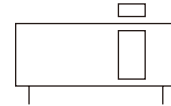

- Neither **MRCH6**, **MRCL16**, **MRCL20**, nor **MRCL25** are suitable for vertical mounting operation.

Magnet Retaining Force

Bore size mm [in.]		6 [0.236]	10 [0.394]	16 [0.630]	20 [0.787]	25 [0.984]	32 [1.260]	40 [1.575]
Item								
H type		20.6 [4.6]	58.8 [13.2]	156.9 [35.3]	294.2 [66.1]	451.1 [101.4]	715.9 [160.9]	1147.4 [257.9]
L type		—	—	73.5 [16.5]	127.5 [28.7]	196.1 [44.1]	313.8 [70.5]	500.1 [112.4]

Remark: Bore sizes 6mm [0.236in.] and 10mm [0.394in.] are available only for H type.

Bore Size and Stroke

Bore size	Standard strokes	Available stroke range
6	50, 100, 150, 200	50~300
10	50, 100, 150, 200, 250, 300	50~500
16	100, 150, 200, 250, 300, 350, 400, 450, 500	50~1000
20	150, 200, 250, 300, 350, 400, 450, 500, 600	50~1500
25	200, 250, 300, 350, 400, 450, 500, 600, 700, 800	50~2000
32	200, 250, 300, 350, 400, 450, 500, 600, 700, 800	50~2000
40	200, 250, 300, 350, 400, 450, 500, 600, 700, 800, 900, 1000	50~2000

Note: The minimum available stroke is 50mm.

Mass

Bore size mm [in.]	Zero stroke mass		Additional mass for each 1mm [0.0394in.] stroke	Additional mass	
	H type	L type		M mount	One sensor switch (with holder)
6 [0.236]	0.05 [0.11]	—	0.0006 [0.00013]	0.027 [0.060]	—
10 [0.394]	0.11 [0.24]	—	0.0013 [0.00029]	0.032 [0.071]	A : 0.025 [0.055] B : 0.055 [0.121] (It is not possible to use for L type)
16 [0.630]	0.21 [0.46]	0.19 [0.42]	0.0029 [0.00064]	0.074 [0.163]	
20 [0.787]	0.41 [0.90]	0.36 [0.79]	0.0035 [0.00077]	0.103 [0.227]	
25 [0.984]	0.55 [1.21]	0.49 [1.08]	0.0045 [0.00099]	0.175 [0.386]	
32 [1.260]	1.03 [2.27]	0.94 [2.07]	0.0065 [0.00143]	0.371 [0.818]	
40 [1.575]	1.83 [4.04]	1.61 [3.55]	0.0081 [0.00179]	0.525 [1.158]	

Order Codes

Magnet retaining force

H type

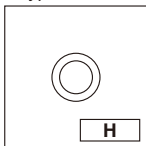

L type

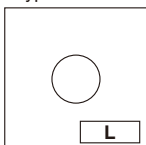

● 6mm [0.236in.] and 10mm [0.394in.] bore sizes are not available.

Magnet retaining force		N [lbf.]					
Bore mm [in.]	6	10	16	20	25	32	40
Type	[0.236]	[0.394]	[0.630]	[0.787]	[0.984]	[1.260]	[1.575]
H type	20.6 [4.63]	58.8 [13.22]	156.9 [35.27]	294.2 [66.14]	451.1 [101.41]	715.9 [160.93]	1147.4 [257.94]
L type	—	—	73.5 [16.52]	127.5 [28.66]	196.1 [44.08]	313.8 [70.54]	500.1 [112.42]

Mounting type

Standard mount

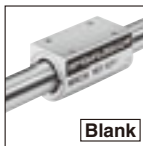

With M mount

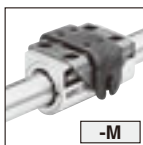

★ Included at shipping.

Sensor switch

(It is not possible to use for L type and the 6mm bore size.)

No sensor switch

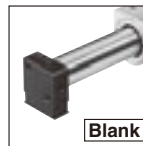

With ZC301

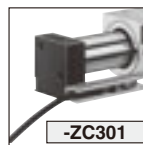

● Reed switch type
● Without indicator lamp
● DC5~28V
● AC85~115V

With ZC305



● Reed switch type
● With indicator lamp
● DC10~28V

Lead wire length

(with sensor switch)

● A : 1000mm [39in.]
● B : 3000mm [118in.]

Number of sensor switches

(with sensor switch)

● 1 : With 1 sensor switch
● 2 : With 2 sensor switches

★ Included at shipping.
★ Due to the end of stroke detection, the maximum number that can be mounted is 2 pcs.

Basic type	Magnet retaining force	Bore size × Stroke	Mounting type	Sensor switch	Lead wire length	Number of sensor switches
MRC	H L	×	-M	-ZC301 -ZC305	A B	1 2

● See the "Bore Size and Stroke" table on the previous page.

● For details, see p.1544.

Inner Construction

H type MRCH10~40

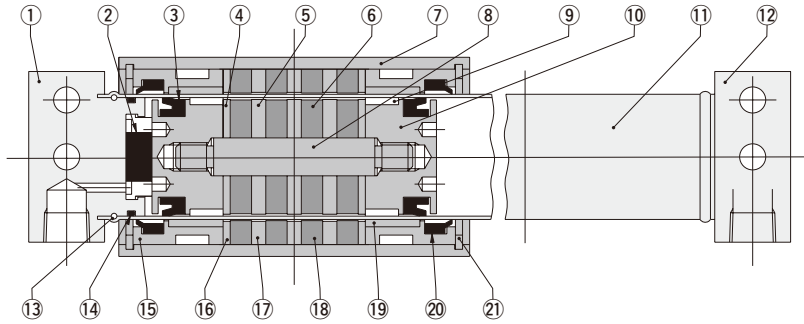

MRCH6

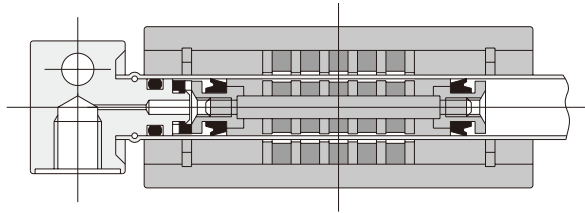

L type MRCL16~40

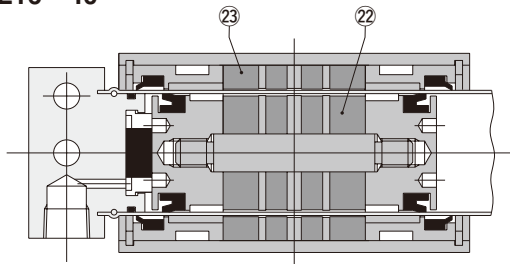

Major Parts and Materials

No.	Parts	Materials	Quantity	Remarks
①	End cover R ^{Note1}	Aluminum alloy (anodized)	1	
②	Bumper	Synthetic rubber (NBR)	2	
③	Piston seal	Synthetic rubber (NBR)	1	2 pcs. for $\phi 6$ [0.236in.]
④	Inner yoke B	Steel (nickel plated)	2	
⑤	Inner yoke A	Steel (nickel plated)	3	1 pc. for L type (4pcs. for $\phi 6$ [0.236in.] and 2pcs. for $\phi 10$ [0.394in.])
⑥	Inner magnet	Rare earth magnet	4	2 pcs. for L type (5pcs. for $\phi 6$ [0.236in.] and 3pcs. for $\phi 10$ [0.394in.])
⑦	Slider	Aluminum alloy (anodized)	1	
⑧	Shaft	Stainless steel	1	
⑨	Inner wear ring	Special plastic	2	
⑩	Piston	Aluminum alloy	2	$\phi 6$ [0.236in.] is brass.
⑪	Cylinder tube	Stainless steel	1	
⑫	End cover L ^{Note2}	Aluminum alloy (anodized)	1	
⑬	Set hoop	Stainless steel	2	
⑭	Tube gasket	Synthetic rubber (NBR)	2	
⑮	Wear ring holder	Aluminum alloy	2	$\phi 6$ [0.236in.] is special plastic, one piece construction with ⑰.
⑯	Outer yoke B	Steel (nickel plated)	2	
⑰	Outer yoke A	Steel (nickel plated)	3	1 pc. for L type (4pcs. for $\phi 6$ [0.236in.] and 2pcs. for $\phi 10$ [0.394in.])
⑱	Outer magnet	Rare earth magnet	4	2 pcs. for L type (5pcs. for $\phi 6$ [0.236in.] and 3pcs. for $\phi 10$ [0.394in.])
⑲	Outer wear ring	Special plastic	2	$\phi 6$ [0.236in.] is one piece construction with ⑮.
⑳	Scraper	Synthetic rubber (NBR)	2	
㉑	Snap ring	Steel	2	
㉒	Inner spacer	Aluminum alloy	2	L type only
㉓	Outer spacer	Aluminum alloy	2	L type only

Notes: 1. When looking the connection ports front, this is the left sided one.
2. When looking the connection ports front, this is the right sided one.

Dimensions of MRC (mm)

MRC Bore size × Stroke



MRC- Bore size

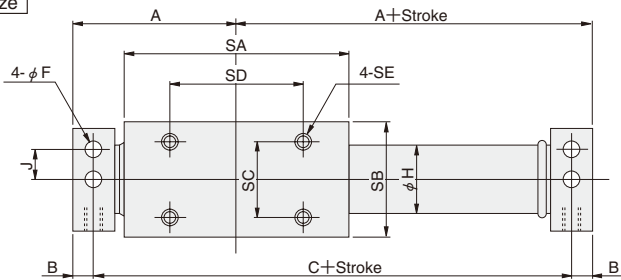

Dimensions of MRCH6 end cover

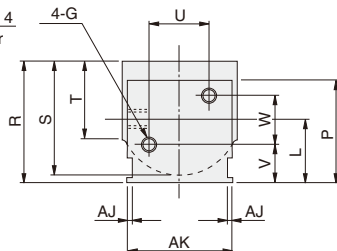
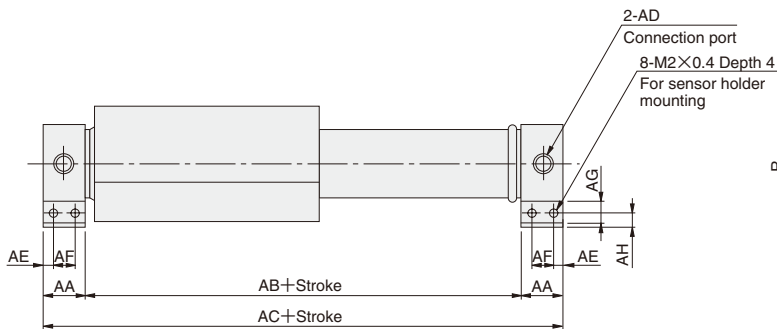
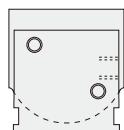
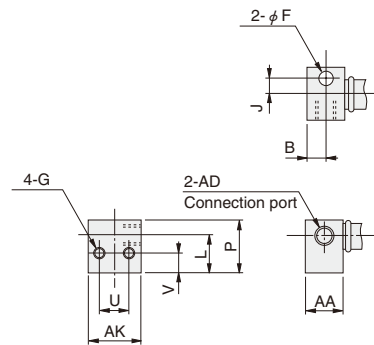

For MRCH10 and MRCL10

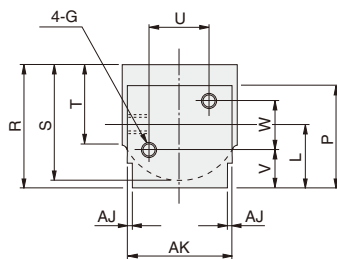

● For MRCH10 connection ports only, 1mm [0.039in.] is offset above the cylinder center line (L+1).

Bore mm [in.]	Code	A	B	C	F	G	H	J	L	P	R	S	T	U	V	W
6	[0.236]	32.5	5	55	3.4	M3×0.5 Depth5	6.8	4	10	14	18.5	17	11	8	5	0
10	[0.394]	33.5	5.5	56	3.4	M3×0.5 Depth6	11	6.5	14	22	26.5	25	16	13	9.5	9
16	[0.630]	43	5.5	75	4.5	M4×0.7 Depth6	17.4	8	17	27	32	30	20	16	11	12
20	[0.787]	53	8	90	4.5	M4×0.7 Depth9	21.4	11	21	33	39	36	24	22	13	16
25	[0.984]	56	8	96	5.5	M5×0.8 Depth9	26.4	12	23	38	44	42	28	24	13	20
32	[1.260]	64	8	112	6.6	M6×1 Depth9	33.6	16	30	48	56	52	35	32	18	24
40	[1.575]	76	10	132	6.6	M6×1 Depth12	41.6	18	37	60	69	64	43	36	23	28

Note : There are no 2 mounting holes in the center line of MRCH6.

Bore mm [in.]	Code	AA	AB	AC	AD	AE	AF	AG	AH	AJ	AK	SA	SB	SC	SD	SE
6	[0.236]	10	45	65	M5×0.8	—	—	—	—	14	41	17	10	25	M3×0.5 Depth4	
10	[0.394]	11	45	67	M5×0.8	2.5	6	6	3.7	0.5	22	41	25	16	22	M3×0.5 Depth6
16	[0.630]	11	64	86	M5×0.8	2.5	6	6	4	1	27	59	30	20	35	M4×0.7 Depth6
20	[0.787]	16	74	106	Rc1/8	2.5	11	6	6	0.5	32	68	36	26	40	M4×0.7 Depth9
25	[0.984]	16	80	112	Rc1/8	2.5	11	6	5	1	36	74	42	30	42	M5×0.8 Depth9
32	[1.260]	16	96	128	Rc1/8	2.5	11	6	8	2	46	87	52	38	55	M6×1 Depth9
40	[1.575]	20	112	152	Rc1/4	2.5	15	6	9	1	50	102	64	50	65	M6×1 Depth15

● M mount: -M

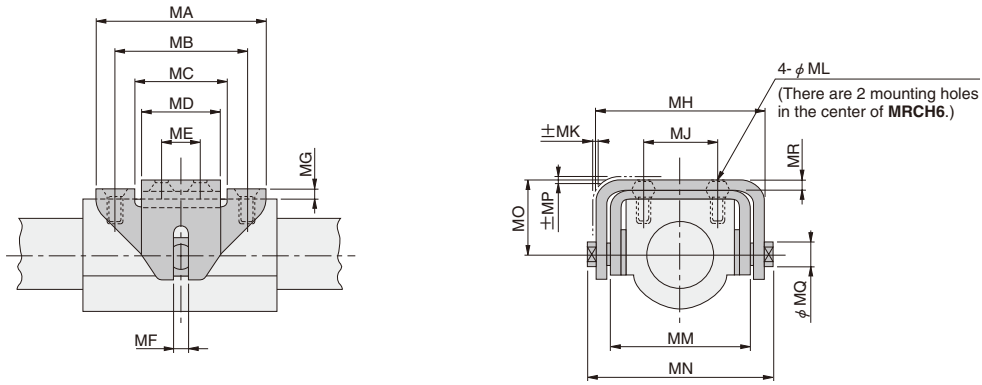

Code Bore size mm [in.]	MA	MB	MC	MD	ME	MF	MG	MH	MJ	MK	ML	MM	MN	MO	MP	MQ	MR
6 [0.236]	32	25	18	16	9	2	2	29	0	1	3.5	23	32	13	2	3	2
10 [0.394]	29	22	15	14	7	2.5	2	37	16	1	3.5	31	40	17	2	4	2
16 [0.630]	45	35	24	20	10	4	2.5	45	20	1	4.5	38	50	20	2	6	2.6
20 [0.787]	52	40	30	26	16	5	2.5	51.2	26	1	4.5	44	54	23	2	8	2.6
25 [0.984]	57	42	31	29	17	6	3.2	61.8	30	1.5	5.5	52.4	66	27	2	10	3.2
32 [1.260]	73	55	39	37	20	8	4.5	79	38	2	6.6	66	84	34	2.5	12	4.5
40 [1.575]	83	65	49	46	30	10	4.5	91	50	2	6.6	78	96	40	2.5	16	4.5

Note : MRCH6 cannot be used in vertical applications.

MRG

With Guide

Symbol

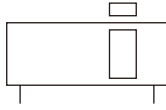

● MRCH6 cannot be used in vertical applications.

Specifications

Bore size mm [in.]		6 [0.236]	10 [0.394]	16 [0.630]	20 [0.787]	25 [0.984]	32 [1.260]	40 [1.575]
Operation type		Double acting type						
Media		Air						
Operating pressure range MPa [psi.]	H type	0.25~0.7 [36~102]			0.2~0.7 [29~102]			
	L type	—			0.18~0.34 [26~49]			
Proof pressure MPa [psi.]		1.03 [149]						
Operating temperature range °C [°F]		0~60 [32~140]						
Operating speed range ^{Note} mm/s [in./sec.]		100~500 [3.9~19.7]						
Cushion		Rubber bumper						
Lubrication		Not required						
Stroke adjusting range mm [in.]		+1~-6 [+0.039~-0.236] (One side) (Fine adjustment at the end of the stroke only)						
Stroke tolerance mm [in.]	1000 or less	+1.5 [+0.059] 0 [0]						
	1001~1500	+2.0 [+0.079] 0 [0]						
Port size		M5×0.8			Rc1/8		Rc1/4	

Note: Adjust the maximum operating speed at 300mm/s [11.8in./sec.] or less when you use the sensor switch for the intermediate positioning because of the response speed of the load relay, etc.

Remark: For details of the sensor switches, see p.1544.

Magnet Retaining Force

Bore size mm [in.]		N [lbf.]						
Type		6 [0.236]	10 [0.394]	16 [0.630]	20 [0.787]	25 [0.984]	32 [1.260]	40 [1.575]
H type		20.6 [4.63]	58.8 [13.21]	156.9 [35.27]	294.2 [66.14]	451.1 [101.41]	715.9 [160.93]	1147.4 [257.94]
L type		—	—	73.5 [16.52]	127.5 [28.66]	196.1 [44.08]	313.8 [70.54]	500.1 [112.42]

Remark: Bore size 6mm [0.236in.] and 10mm [0.394in.] are only available in H type.

MAGNET TYPE RODLESS CYLINDERS MRC, MRG SERIES

Bore Size and Stroke

Bore size	Standard strokes		Available stroke range
	mm		
6	50, 100, 150, 200		0~300
10	50, 100, 150, 200, 250, 300		0~500
16	100, 150, 200, 250, 300, 350, 400, 450, 500		0~750
20	150, 200, 250, 300, 350, 400, 450, 500, 600		0~1000
25	200, 250, 300, 350, 400, 450, 500, 600, 700, 800		0~1500
32	200, 250, 300, 350, 400, 450, 500, 600, 700, 800		0~1500
40	200, 250, 300, 350, 400, 450, 500, 600, 700, 800, 900, 1000		0~1500

Specifications of Shock Absorber (Optional)

Item	Model	KSHDM	KSHDM	KSHDM	KSHDM	KSHDM	KSHDM	KSHDM
		5×6	5×8	5×10	6×10	8×12	10×15	12×18
Applicable cylinder		MRGH6	MRGH10	MRG□16	MRG□20	MRG□25	MRG□32	MRG□40
Maximum absorption	J [ft·lbf]	0.5 [0.37]	1.0 [0.74]	2.5 [1.84]	3.9 [2.88]	5.9 [4.35]	13.3 [9.81]	26.5 [19.55]
Absorbing stroke	mm [in.]	6 [0.236]	8 [0.315]	10 [0.394]	10 [0.394]	12 [0.472]	15 [0.591]	18 [0.709]
Maximum impact speed	mm/s [in./sec.]	800 [31.5]						
Maximum operating frequency	cycle/min	60						
Spring return force ^{Note}	N [lbf.]	4.9 [1.10]	7.8 [1.75]	6.9 [1.55]	6.9 [1.55]	19.6 [4.41]	14.7 [3.30]	16.7 [3.75]
Angle variation		2° or less						
Operating temperature range	°C [°F]	0~60 [32~140]						

Note : The value at retracted position.

Caution: The life of the shock absorber may vary from the magnet type rodless cylinder, depending on its operating conditions.

Mass

Bore size mm [in.]	Zero stroke mass		Additional mass for each 1mm [0.0394in.] stroke	Additional mass	
	H type	L type		Shock absorber	One sensor switch (with holder)
6 [0.236]	0.26 [0.57]	—	0.0007 [0.0015]	0.015 [0.033]	A : 0.05 [0.11] B : 0.09 [0.20]
10 [0.394]	0.47 [1.04]	—	0.0016 [0.0035]	0.027 [0.060]	
16 [0.630]	0.77 [1.70]	0.71 [1.57]	0.0023 [0.0051]	0.033 [0.073]	
20 [0.787]	1.27 [2.80]	1.22 [2.69]	0.0032 [0.0071]	0.055 [0.121]	
25 [0.984]	1.67 [3.68]	1.61 [3.55]	0.0040 [0.0088]	0.086 [0.190]	
32 [1.260]	3.11 [6.86]	3.00 [6.62]	0.0060 [0.0132]	0.166 [0.366]	
40 [1.575]	5.20 [11.47]	4.88 [10.76]	0.0090 [0.0198]	0.225 [0.496]	

Order Codes

Magnet retaining force

H type

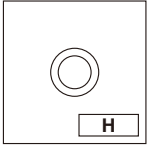

L type

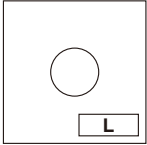

● 6mm [0.236in.] and 10mm [0.394in.] bore size are not available.

Magnet retaining force		N [lbf.]					
Bore mm [in.]	6	10	16	20	25	32	40
Type	[0.236]	[0.394]	[0.630]	[0.787]	[0.984]	[1.260]	[1.575]
H type	20.6 [4.63]	58.8 [13.22]	156.9 [35.27]	294.2 [66.14]	451.1 [101.41]	715.9 [160.93]	1147.4 [257.94]
L type	—	—	73.5 [16.52]	127.5 [28.66]	196.1 [44.08]	313.8 [70.54]	500.1 [112.42]

Shock absorber

● Standard comes with a stopper bolt.

No shock absorber



With shock absorber

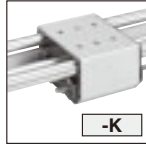

★ Included at shipping.

Sensor switch

No sensor switch

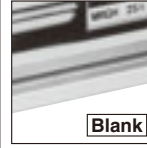

With ZG530



● Solid state type
● With indicator lamp
● DC10~28V

With ZG553



● Solid state type
● With indicator lamp
● DC4.5~28V

With CS3M



● Reed switch type
● With indicator lamp
● DC10~30V
AC85~230V

With CS4M

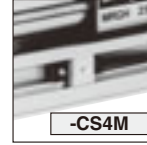

● Reed switch type
● With indicator lamp
● DC10~30V
AC85~230V

With CS5M

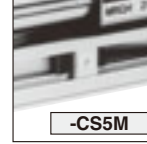

● Reed switch type
● Without indicator lamp
● DC3~30V
AC85~115V

Lead wire length (with sensor switch)

● A : 1000mm [39in.]
● B : 3000mm [118in.]

Number of sensor switches (with sensor switch)

● 1 : With 1 sensor switch
● 2 : With 2 sensor switches

★ Included at shipping.
★ Please fill in the quantities when you use 3 or more sensor switches.

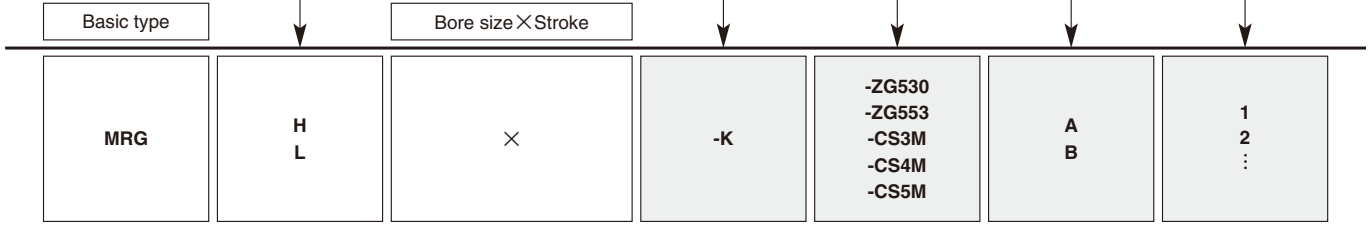

● For details, see p.1544.

● With a shock absorber for cylinder strokes less than 100mm, it is made to order.

● See the "Bore Size and Stroke" table on the previous page.

Additional Parts (To be Ordered Separately)

Shock absorber



- For ϕ 6 [0.236in.] cylinder — **KSHDM 5×6**
- For ϕ 10 [0.394in.] cylinder — **KSHDM 5×8**
- For ϕ 16 [0.630in.] cylinder — **KSHDM 5×10**
- For ϕ 20 [0.787in.] cylinder — **KSHDM 6×10**
- For ϕ 25 [0.984in.] cylinder — **KSHDM 8×12**
- For ϕ 32 [1.260in.] cylinder — **KSHDM 10×15**
- For ϕ 40 [1.575in.] cylinder — **KSHDM 12×18**

Note: Mounting nut is not included, please use the mounting nut of the stopper bolt (common parts) to install.

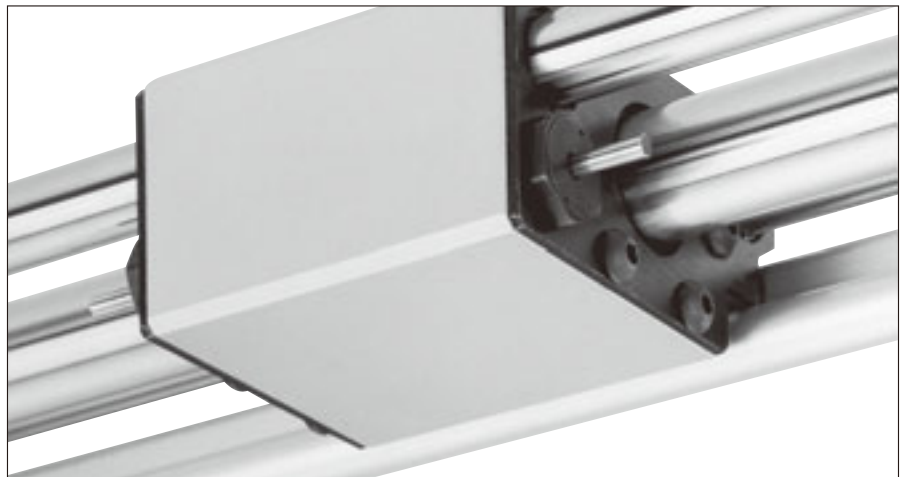

Inner Construction

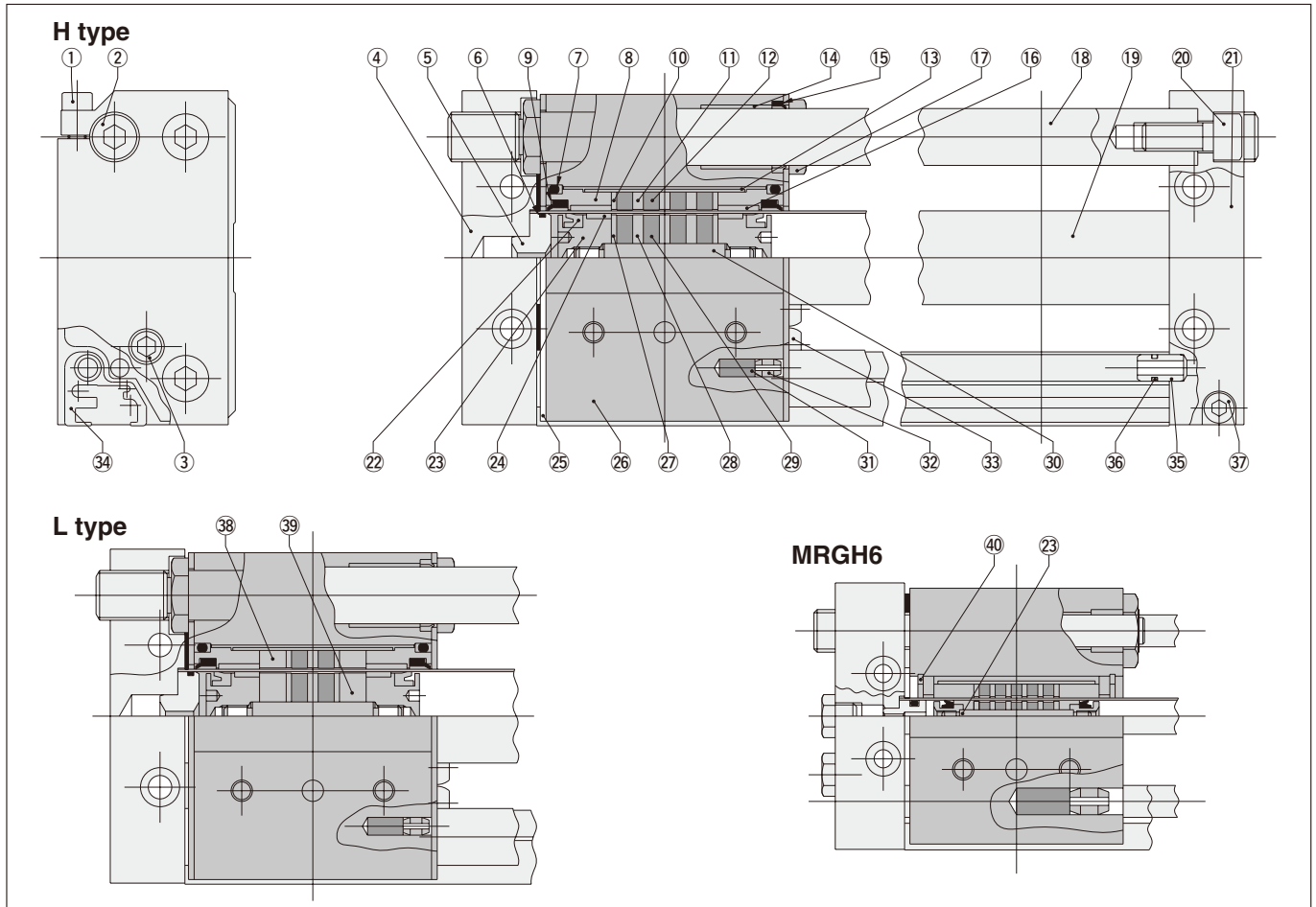

Major Parts and Materials

No.	Parts	Materials	Quantity	Remarks
①	Lock screw for stroke adjusting bolt	Alloy steel	2	Hexagon socket head bolt
②	Stroke adjusting bolt	Alloy steel	2	
③	Plug	Steel	3	
④	End cover R ^{Note1}	Aluminum alloy (anodized)	1	
⑤	End pipe	Aluminum alloy	2	
⑥	Cylinder gasket	Synthetic rubber (NBR)	2	
⑦	Slider gasket	Synthetic rubber (NBR)	2	Not available in $\phi 6$ [0.236in.]
⑧	Scraper holder	Aluminum alloy (anodized)	2	Steel for $\phi 6$ [0.236in.]
⑨	Scraper	Synthetic rubber (NBR)	2	
⑩	Outer yoke B	Steel (nickel plated)	2	
⑪	Outer yoke A	Steel (nickel plated)	3	1 pc. for L type (4 for $\phi 6$ and 2 for $\phi 10$)
⑫	Outer magnet	Rare earth magnet	4	2 pcs. for L type (5 for $\phi 6$ and 3 for $\phi 10$)
⑬	Slider tube	Stainless steel	1	
⑭	Bushing	PTFE layer with filling material	4	
⑮	Scraper	Synthetic rubber (NBR)	4	Not available in $\phi 6$ [0.236in.]
⑯	Bushing	Special plastic	2	
⑰	Stopper bolt	Carbon steel	1	Shock absorber (Optional)
⑱	Guide shaft	Carbon steel (hard chrome plated)	2	
⑲	Cylinder tube	Aluminum alloy (anodized)	1	Stainless steel for $\phi 6$, $\phi 10$ and $\phi 16$
⑳	Guide shaft mounting screw	Alloy steel	3	Hexagon socket head bolt
㉑	End cover L ^{Note2}	Aluminum alloy (anodized)	1	

No.	Parts	Materials	Quantity	Remarks
㉒	Piston seal	Synthetic rubber (NBR)	1	
㉓	Piston	Aluminum alloy	2	Brass for $\phi 6$ piston
㉔	Inner wear ring	Special plastic	2	
㉕	Scraper plate	Steel (phosphate coating)	2	Not available in $\phi 6$ [0.236in.]
㉖	Slider	Aluminum alloy (anodized)	1	
㉗	Inner yoke B	Steel (nickel plated)	2	
㉘	Inner yoke A	Steel (nickel plated)	3	1 pc. for L type (4 for $\phi 6$ and 2 for $\phi 10$)
㉙	Inner magnet	Rare earth magnet	4	2 pcs. for L type (5 for $\phi 6$ and 3 for $\phi 10$)
㉚	Shaft	Stainless steel	1	
㉛	Magnet for sensor switch	Rare earth magnet	1	
㉜	Magnetic holder	Plastic	1	
㉝	Scraper plate mounting screw	Alloy steel	6	Hexagon socket head bolt, brass for $\phi 6$ [0.236in.]
㉞	Sensor switch mounting rail	Aluminum alloy (anodized)	1	Also used as bypass pipe
㉟	Pipe	Aluminum alloy	2	
㊱	Pipe gasket	Synthetic rubber (NBR)	2	
㊲	Pipe mounting screw	Alloy steel	1	Hexagon socket head bolt
㊳	Outer spacer	Aluminum alloy	2	L type only
㊴	Inner spacer	Aluminum alloy	2	L type only
㊵	Snap ring	Steel	2	

Notes: 1. This is the side where concentrated piping can be done.
 2. When looking the sensor rail front, this is the right sided one.

Dimensions of MRG (mm)

MRG Bore size × Stroke

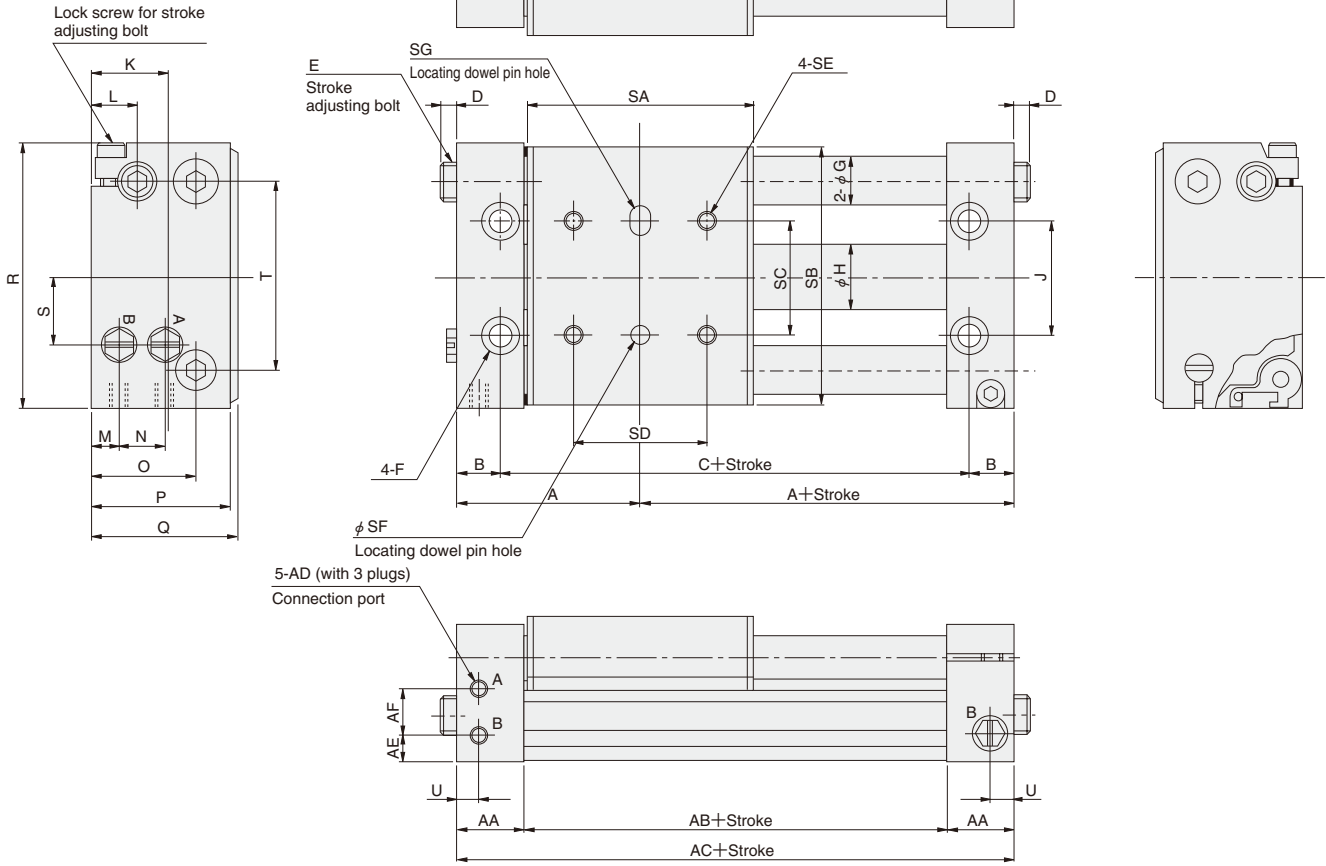

Code	A	B	C	D	E	F	G	H	J	K	L
Bore size mm [in.]											
6 [0.236]	34	9	50	4	M8×1.25 l = 14	φ 3.4 Counterbore φ 6.5 Depth 3.3	6	6.8	16	14.5	10
10 [0.394]	37.5	9	57	3	M10×1.5 l = 15	φ 4.5 Counterbore φ 8 Depth 4.5	10	11	20	18	12
16 [0.630]	48	11	74	4	M10×1.5 l = 18	φ 5.5 Counterbore φ 9.5 Depth 5	12	17.4	30	20	12
20 [0.787]	52.5	13	79	3	M12×1.75 l = 19	φ 5.5 Counterbore φ 9.5 Depth 5.5	14	21.4	35	24	15
25 [0.984]	57	14	86	4	M14×2 l = 20	φ 6.6 Counterbore φ 11 Depth 6.5	16	26.4	40	26	16
32 [1.260]	68.5	16	105	2	M18×2.5 l = 22	φ 9 Counterbore φ 14 Depth 8.5	20	33.6	50	31	20
40 [1.575]	76.5	19	115	4	M20×2.5 l = 25	φ 9 Counterbore φ 14 Depth 8.5	25	41.6	65	37.5	24

Code	M	N	O	P	Q	R	S ^{Note}	T	U	AA	AB	AC	AD
Bore size mm [in.]													
6 [0.236]	6	8.5	22	26	27	50	11	32	5	13	42	68	M5×0.8
10 [0.394]	6	11.5	26	33	34	60	16	44	5	14	47	75	M5×0.8
16 [0.630]	7	12	27	36	38	70	18	50	5.5	17	62	96	M5×0.8
20 [0.787]	8	14.5	33	44	46	84	23	60	7.5	19	67	105	Rc1/8
25 [0.984]	8.5	16.5	36	48	50	94	25	68	7.5	21	72	114	Rc1/8
32 [1.260]	10	20	44	58	60	116	32	85	8	25	87	137	Rc1/8
40 [1.575]	12	24	52	70	72	140	41	102	10	28	97	153	Rc1/4

Note : The distance to the connection port 'A' of MRGH6 is 0.

Code	AE	AF	SA	SB	SC	SD	SE	SF	SG
Bore size mm [in.]									
6 [0.236]	6	10.5	40	48	20	20	M4×0.7 Depth 7	φ 4H8 Depth 4	4 ^{+0.1} ₀ × 6 (Oval shape) Depth 4
10 [0.394]	6	11.5	45	59	25	25	M4×0.7 Depth 7	φ 4H8 Depth 4	4 ^{+0.1} ₀ × 6 (Oval shape) Depth 4
16 [0.630]	7	12	60	68	30	35	M5×0.8 Depth 8	φ 5H8 Depth 5	5 ^{+0.1} ₀ × 7 (Oval shape) Depth 5
20 [0.787]	8	14.5	65	82	36	38	M5×0.8 Depth 9	φ 5H8 Depth 5	5 ^{+0.1} ₀ × 7 (Oval shape) Depth 5
25 [0.984]	8.5	16.5	70	92	42	40	M6×1 Depth 10	φ 6H8 Depth 6	6 ^{+0.1} ₀ × 8 (Oval shape) Depth 6
32 [1.260]	10	20	85	114	52	50	M8×1.25 Depth 14	φ 8H8 Depth 8	8 ^{+0.1} ₀ × 10 (Oval shape) Depth 8
40 [1.575]	12	24	95	138	62	55	M8×1.25 Depth 16	φ 8H8 Depth 8	8 ^{+0.1} ₀ × 10 (Oval shape) Depth 8

Additional Parts

● Shock absorber

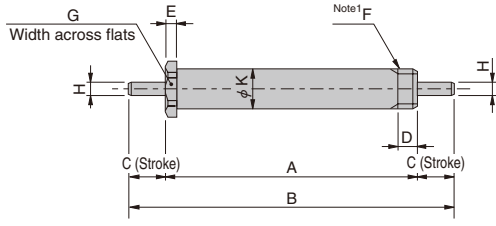

mm [in.]

Code	A	B	C	D	F	G	H	K	E
KSHDM5×6 (For ϕ 6 [0.236])	46	58	6	5	M8×1	12	2.5	8 ^{-0.03} _{-0.17}	2.8
KSHDM5×8 (For ϕ 10 [0.394])	51	67	8	5	M10×1	14	3	10 ^{-0.03} _{-0.18}	2.8
KSHDM5×10 (For ϕ 16 [0.630])	66	86	10	5	M10×1	14	3	10 ^{-0.03} _{-0.18}	2.8
KSHDM6×10 (For ϕ 20 [0.787])	73	93	10	7	M12×1	17	3	12 ^{-0.04} _{-0.19}	3.8
KSHDM8×12 (For ϕ 25 [0.984])	80	104	12	8	M14×1.5	19	5	14 ^{-0.04} _{-0.21}	4.8
KSHDM10×15 (For ϕ 32 [1.260])	99	129	15	10	M18×1.5	22	5	18 ^{-0.05} _{-0.22}	6.8
KSHDM12×18 (For ϕ 40 [1.575])	109	145	18	10	M20×1.5	24	5	20 ^{-0.05} _{-0.22}	6.8

- Notes: 1. Mounting nut is not included, use the mounting nut of the stopper bolt (common parts) to install.
 2. Tightening torque of the nut when installing the shock absorber should not be exceeding the value of the table below.

N-cm [in-lbf]

Model	Tightening torque
KSHDM5×6	196 [17.3]
KSHDM5×8	588 [52.0]
KSHDM5×10	588 [52.0]
KSHDM6×10	1177 [104.2]
KSHDM8×12	1569 [138.9]
KSHDM10×15	1961 [173.6]
KSHDM12×18	2942 [260.4]

SENSOR SWITCHES

Solid State Type, Reed Switch Type

Order Codes for Sensor Switch

Sensor switch for MRC (Not available in MRC6)

● Sensor switch (with holder)

			Sensor switch model	Lead wire length	Basic cylinder type	Bore size	
Reed switch type	Without indicator lamp	DC5~28V	ZC301	A B	-MRC	10	
		AC85~115V				16	
	With indicator lamp	DC10~28V				ZC305	20
							25
					32		
					40		

- A : 1000mm [39in.]
- B : 3000mm [118in.]

● Order codes for sensor holder only

C3 - MRC

Basic cylinder type

Bore size

- 10 : For ϕ 10 [0.394in.]
- 16 : For ϕ 16 [0.630in.]
- 20 : For ϕ 20 [0.787in.]
- 25 : For ϕ 25 [0.984in.]
- 32 : For ϕ 32 [1.260in.]
- 40 : For ϕ 40 [1.575in.]

Sensor switch for MRG

● Sensor switch (with holder)

			Sensor switch model	Lead wire length	Basic cylinder type	Bore size
Solid state type	2-lead wire	With indicator lamp	ZG530	A B	-MRG	6
		DC10~28V				10
Solid state type	3-lead wire	With indicator lamp	ZG553			16
		DC4.5~28V				20
Reed switch type	2-lead wire	With indicator lamp	CS3M			25
		DC10~30V				32
Reed switch type	2-lead wire	With indicator lamp	CS4M			40
		DC10~30V				
Reed switch type	2-lead wire	Without indicator lamp	CS5M			
		DC3~30V				
		AC85~115V				

- A : 1000mm [39in.]
- B : 3000mm [118in.]

● Order codes for sensor holder only

G5 - MRG

Basic cylinder type

Bore size

- 6 : For ϕ 6 [0.236in.]
- 10 : For ϕ 10 [0.394in.]
- 16 : For ϕ 16 [0.630in.]
- 20 : For ϕ 20 [0.787in.]
- 25 : For ϕ 25 [0.984in.]
- 32 : For ϕ 32 [1.260in.]
- 40 : For ϕ 40 [1.575in.]

● For details of the sensor switches, see p.1544.

Moving Sensor Switch

● For MRC

Loosening the mounting screw allows the sensor switch to be moved freely in the cylinder's axial direction. Tighten the mounting screw with a tightening torque of 0.2N·m [1.8in·lbf].

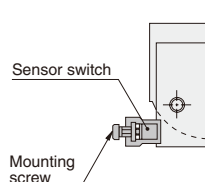

● For MRG

Loosening the sensor holder mounting screw (screw size M3) with an Allen wrench (nominal size 1.5) allows the sensor switch to be moved in the direction of the stroke.

(Tightening torque should be 0.2N·m [1.8in·lbf].)

● MRG6~16

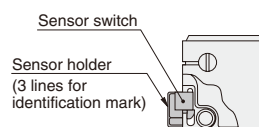

● MRG20~40

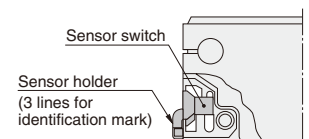

Sensor Switch Operating Range, Response Differential, and Maximum Sensing Location

● Operating range: ℓ

The distance the piston travels in one direction, while the switch is in the ON position.

● Response differential: C

The distance between the point where the piston turns the switch ON and the point where the switch is turned OFF as the piston travels in the opposite direction.

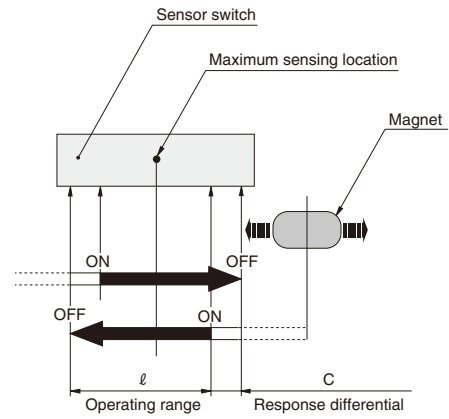

● MRC (Basic type)

mm [in.]

Sensor switch model	ZC301□, ZC305□					
Bore size	10 [0.394]	16 [0.630]	20 [0.787]	25 [0.984]	32 [1.260]	40 [1.575]
Operating range: ℓ	4.3~6.8 [0.169~0.268]	4.2~7.0 [0.165~0.276]	6.0~9.3 [0.236~0.366]	5.5~8.5 [0.217~0.335]	7.0~9.6 [0.276~0.378]	8.3~11.2 [0.327~0.441]
Response differential ^{Note1} : C	1.3 [0.051] or less	1.5 [0.059] or less	1.2 [0.047] or less	1.2 [0.047] or less	1.2 [0.047] or less	1.2 [0.047] or less
Maximum sensing location ^{Note2}			ZC301 : 7 [0.276]	ZC305 : 10.5 [0.413]		

Remark: The values in the above table are reference values.

- Notes: 1. These are values at the ambient temperature of 25°C [77°F].
 2. They are values measured from the end of the sensor switch.

● MRG (with guide)

mm [in.]

Sensor switch model	ZG530□, ZG553□	CS3M□, CS4M□, CS5M□
Operating range: ℓ	3.0~5.0 [0.118~0.197]	5~9.8 [0.197~0.386]
Response differential ^{Note1} : C	0.7 [0.028] or less	1.5 [0.059] or less
Maximum sensing location ^{Note2}	11 [0.433]	

Remark : The values in the above table are reference values.

- Notes: 1. These are values at the ambient temperature of 25°C [77°F].
 2. This is the length measured from the switch's opposite end side to the lead wire.

Dimensions of Sensor Switches and Mounting Location

● For MRC

When the sensor switch is mounted in the locations shown below (the A and B dimensions in the table are reference values), the magnet comes to the maximum sensing location of the sensor switch at the end of the stroke.

Note: Secure the SUS plate on the sensor switch with a screw.

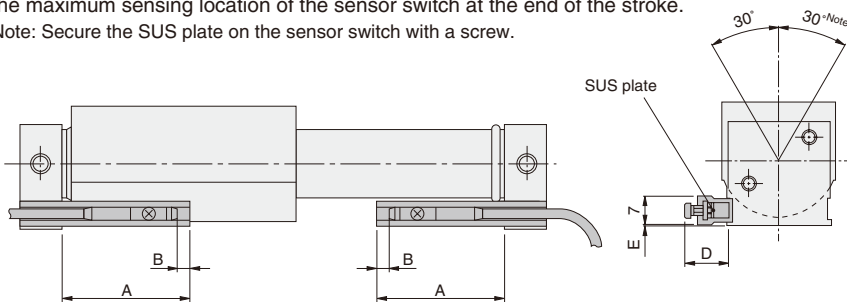

Note: This is the allowable swing angle of the slider at the end of the stroke.

■ H type

mm [in.]

Cylinder model	Sensor switch model	Code			
		A	B	D	E
MRCH10	ZC301 □	28	3.5 [0.138]	12	0.2
	ZC305 □	[1.102]	0	[0.472]	[0.008]
MRCH16	ZC301 □	33	3.5 [0.138]	11.5	0.5
	ZC305 □	[1.299]	0	[0.453]	[0.020]
MRCH20	ZC301 □	36	3.5 [0.138]	11.5	2.5
	ZC305 □	[1.417]	0	[0.453]	[0.098]
MRCH25	ZC301 □	39	3.5 [0.138]	11.5	1.5
	ZC305 □	[1.535]	0	[0.453]	[0.059]
MRCH32	ZC301 □	43.5	3.5 [0.138]	10.5	4.5
	ZC305 □	[1.713]	0	[0.413]	[0.177]
MRCH40	ZC301 □	49	3.5 [0.138]	11.5	5.5
	ZC305 □	[1.929]	0	[0.453]	[0.217]

Notes: 1. Sensor switch cannot be used for L type and MRCH6.
2. The intermediate stroke position cannot be detected with a sensor switch.

● For MRG

When the sensor switch is mounted in the locations shown below, the magnet comes to the maximum sensing location of the sensor switch at the end of the stroke.

● MRG6~16

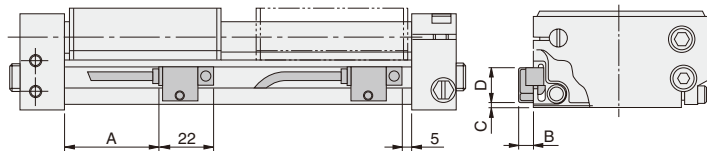

● MRG20~40

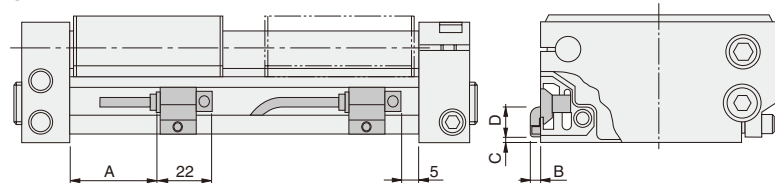

■ H type and L type

mm [in.]

Code	A	B	C	D
MRGH6	16 [0.630]	6 [0.236]	2 [0.079]	13.5 [0.531]
MRGH10	21 [0.827]	6 [0.236]	2 [0.079]	13.5 [0.531]
MRG □ 16	35 [1.378]	6 [0.236]	2.5 [0.098]	13.5 [0.531]
MRG □ 20	40 [1.575]	4.5 [0.177]	1 [0.039]	11 [0.433]
MRG □ 25	45 [1.772]	4.5 [0.177]	2.5 [0.098]	11 [0.433]
MRG □ 32	60 [2.362]	3.5 [0.138]	7.5 [0.295]	11 [0.433]
MRG □ 40	70 [2.756]	3.5 [0.138]	11.5 [0.453]	11 [0.433]

If the stroke in the cylinder is less than the figures in the table below, the intermediate stroke position can be detected with a sensor switch.

Maximum stroke that enables detection of intermediate stroke positions

Bore size	6 [0.236]	10 [0.394]	16 [0.630]	20 [0.787]	25 [0.984]	32 [1.260]	40 [1.575]
Stroke	300	500	750	750	800	800	800

Handling Instructions and Precautions



Selection and Mounting

Allowable load and moment

Although the magnet type rodless cylinders MRC, MRG series can be used with directly applying loads, make sure that the load and moment do not exceed the values in the table below.

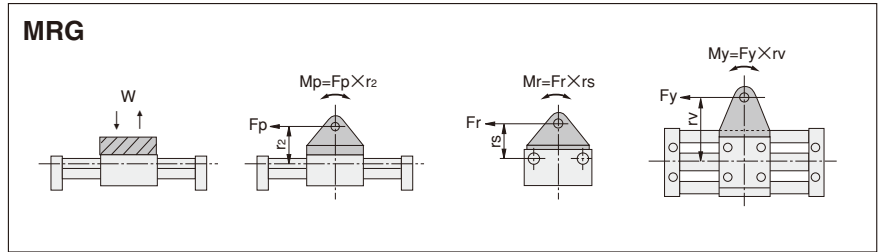
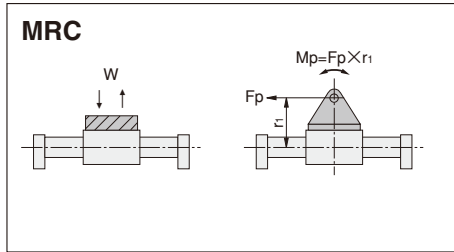

Bore size mm [in.]	MRC			MRG			
	Maximum load capacity W ^{Note1} N [lbf.]		Pitching moment M_p N·m [ft·lbf]	Maximum load capacity W ^{Note1} N [lbf.]	Pitching moment M_p N·m [ft·lbf]	Rolling moment M_r ^{Note1} N·m [ft·lbf]	Yawing moment M_y N·m [ft·lbf]
	H type	L type					
6 [0.236]	3.9 [0.88]	—	0.10 [0.07]	14.7 [3.30]	0.29 [0.21]	0.06 [0.04]	0.29 [0.21]
10 [0.394]	11.8 [2.65]	—	0.29 [0.21]	39.2 [8.81]	0.98 [0.72]	0.20 [0.15]	0.98 [0.72]
16 [0.630]	29.4 [6.61]	14.7 [3.30]	1.18 [0.87]	78.5 [17.65]	2.45 [1.81]	0.49 [0.36]	2.45 [1.81]
20 [0.787]	49 [11.02]	24.5 [5.51]	2.45 [1.81]	127.5 [28.66]	5.39 [3.98]	1.08 [0.80]	5.39 [3.98]
25 [0.984]	78.5 [17.65]	39.2 [8.81]	3.92 [2.89]	196.1 [44.08]	9.81 [7.24]	1.96 [1.45]	9.81 [7.24]
32 [1.260]	117.7 [26.46]	58.8 [13.22]	8.83 [6.51]	313.8 [70.54]	15.7 [11.6]	3.14 [2.32]	15.7 [11.6]
40 [1.575]	176.5 [39.68]	88.3 [19.85]	13.7 [10.11]	490.3 [110.22]	24.5 [18.1]	4.90 [3.61]	24.5 [18.1]

Notes: 1. W and Mr are the maximum values, and are different depending on the stroke. Refer to the graphs below.
2. Cylinder thrust Fp and Fy should be 60% or less of the magnet retaining force.

The maximum load capacity and stroke

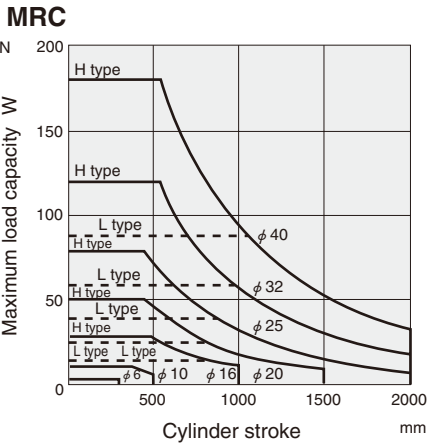

Cylinder stroke and rolling moment

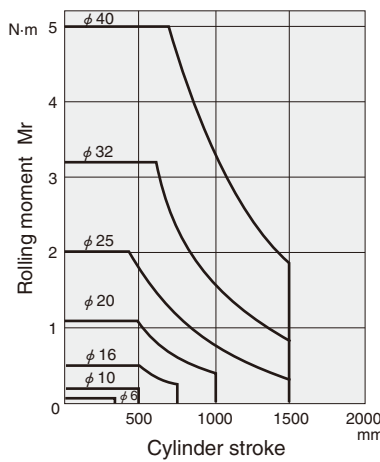

The mass and speed that can be stopped with a stopper bolt

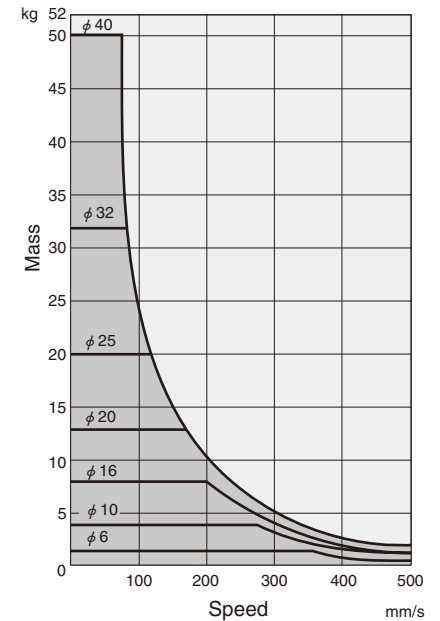

1kg = 2.205lb. 1mm/s = 0.0394in./sec.

Range of possible use

For the MRG series with stopper bolts, use within the allowable operating range of the mass and speed in the graph. If one of these is exceeded, use a type with a shock absorber.

MRG

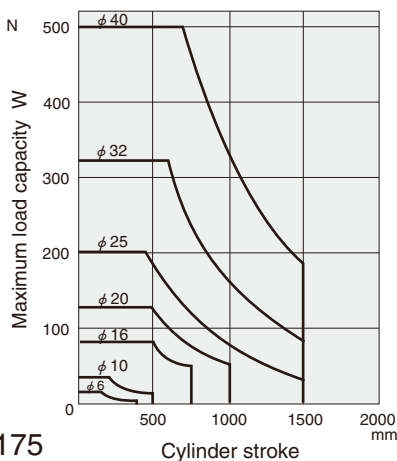

1N = 0.2248lbf.
1mm = 0.0394in.
1N·m = 0.7376ft·lbf

Relationship between the load and operating pressure in vertical operation

MRCL

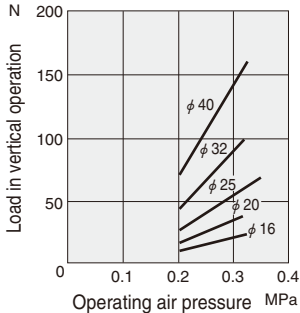

MRCH

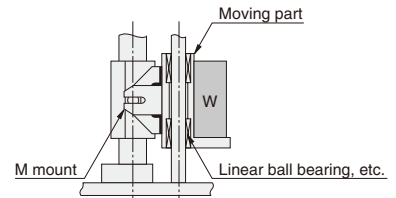
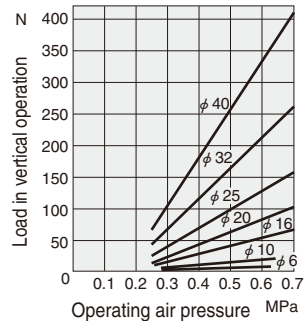

Caution: Neither **MRCH6**, **MRCL16**, **MRCL20** nor **MRCL25** are suitable for operation with vertical installation.

MRG

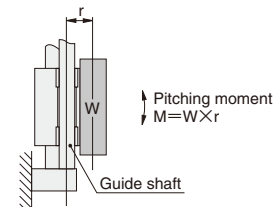
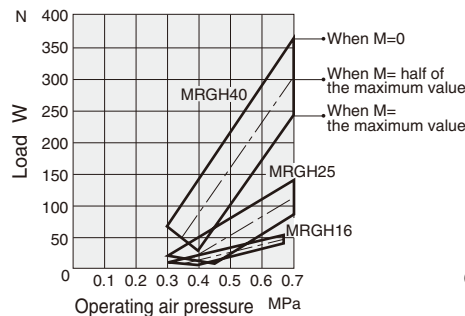
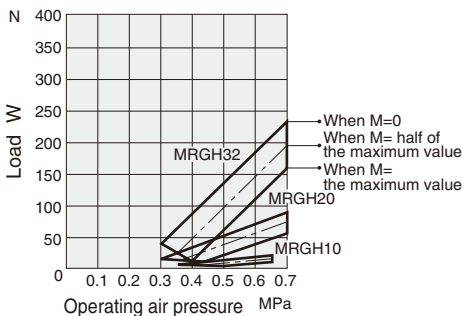

Caution: **MRGH6** cannot be used with vertical installation.

1N = 0.2248lbf. 1MPa = 145psi.

Stopping at the intermediate stroke

The operating air pressure when the load is stopped during the stroke by an external stopper, etc., should be less than 0.55MPa [80psi.] with the H type, and less than 0.27MPa [39psi.] with the L type.

If used with more pressure than the above, the piston alignment may be off, please be careful.

Mounting

1. Because strong magnets are built into the **MRC** and the **MRG** series magnet type rodless cylinder's tube, they cannot be used where there is any magnetized cutting oil or metal chips, etc.
2. Care must be exercised not to damage or dent the cylinder tube or the guide shaft.
3. If misalignment between slider and piston occurs, or if they come out due to external force exceeding the magnet retaining force, apply an external force to the slider and put the slider back in its correct alignment when the piston comes to the end of the stroke.
4. Clean periodically when using where the cylinder tube or the guide shaft easily becomes smeared. Apply lubricant on the surface of the cylinder tube and the guide shaft after cleaning.
5. With the **MRC** series, be sure to install a guide outside by using an M mount, as shown in the diagrams to the right, because the slider rotates freely.
6. With the **MRG** series, do not use an external guide such as a linear ball bearing. Install and use an **M** mount for the **MRC** series when the external guide is installed and used.
7. The **H** type of the **MRC** series (except **MRCH6**) can detect the position at the end of the stroke just by installing a sensor switch, but the sensor switch does not always work properly, depending on how the cylinder is mounted.

When the bottom of the slider is close to the magnetic material mounting surface of the equipment, use a spacer etc., as shown in the diagram to the right, and install it 5mm [0.20in.] or more apart.

8. Periodic greasing is necessary for the **MRC** and the **MRG** series.

For the **MRC** series, apply grease on outer surface of the cylinder tube, and for the **MRG**, grease on the outer surface of the cylinder tube and the guide shaft, about every 300km [186mi.] traveling distance.

(Recommended grease)

MRC6 and **MRG6**: Fluorine-contained lithium type grease

Excluding the above: Synthetic hydrocarbon type grease

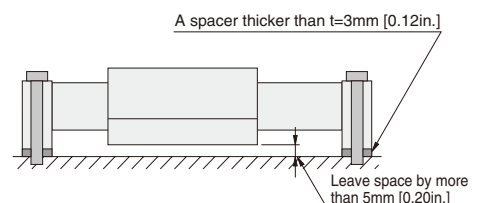
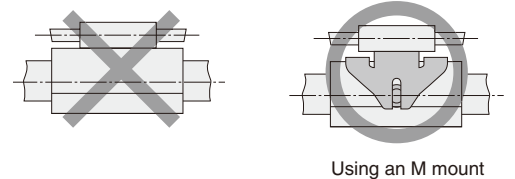

Handling Instructions and Precautions



General precautions

Piping

Always thoroughly blow off (use compressed air) the tubing before connecting it to the cylinder. Entering chips, sealing tape, rust, etc., generated during piping work could result in air leaks or other defective operation.

Atmosphere

1. If using in locations subject to dripping water, dripping oil, etc., or to large amounts of dust, use a cover to protect the unit.
2. The product cannot be used when the media or ambient atmosphere contains any of the substances listed below.
Organic solvents, phosphate ester type hydraulic oil, sulphur dioxide, chlorine gas, or acids, etc.

Lubrication

The product can be used without lubrication, if lubrication is required, use Turbine Oil Class 1 (ISO VG32) or equivalent.

Avoid using spindle oil or machine oil.

Media

1. Use air for the media. For the use of any other media, consult us.
2. Air used for the rodless cylinder should be clean air that contains no deteriorated compressor oil, etc. Install an air filter (filtration of a minimum 40 µm) near the rodless cylinder or valve to remove collected liquid or dust. In addition, drain the air filter periodically.