

MPS/MST

SERIES

S PIN - ON FILTER SUCTION - RETURN



MPFILTRI
filtri per oleodinamica



Maximum working pressure 175 PSI

Flow rates to 80 GPM

Description

MPS / MST

The **MPS** spin-on filter series is a complete product range suitable, for both suction and return applications.

Utilising spin-on canisters, the MPS series are quick and easy to service and provide a 'clean' solution when changing elements.

The filter elements are either resin-impregnated paper ($\beta_x > 2$), glass fibre ($\beta_x \geq 75$) or square wire mesh.

The unique filter head is designed for both European CS and American CSG standard canister series. One head design series accommodates both styles of elements.

Also available is a new design utilizing a pressure differential visual and electrical indicators - ideal for lubrication applications.

MPS filters are specifically designed for contamination control in hydraulic and lubrication circuits, mobile and agricultural applications and machine tool systems.

The **CSGW** series of canister removes water from oil while filtering the oil at the same time.

Water absorbent polymers up to 800 times their own weight, provide this major feature.

Water holding capacities: - CSGW 050 - 240 ml.
CSGW 150 - 788 ml.

DIFFERENTIAL INDICATORS For Use with series "1" filter heads.



For Use with series "0" filter head.

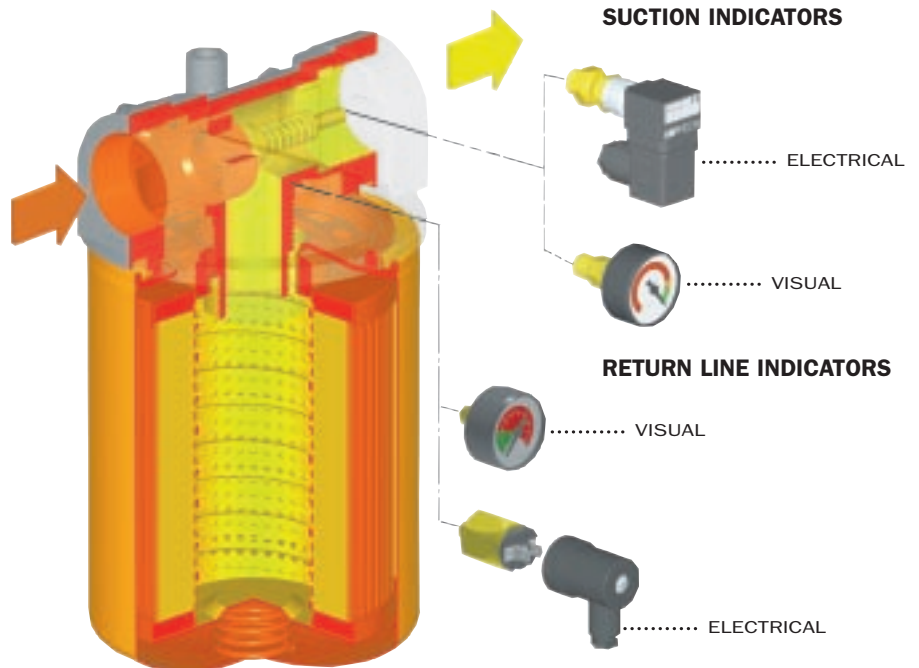

New

absolute filter elements
independently tested
in the following Institutes:

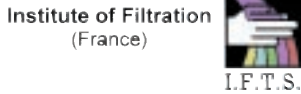

Filter element:

Materials

End caps:

Galvanized steel

Support tube:

Galvanized steel

Support frames:

Galvanized steel with an epoxy coating

A Series

Inorganic microfibre

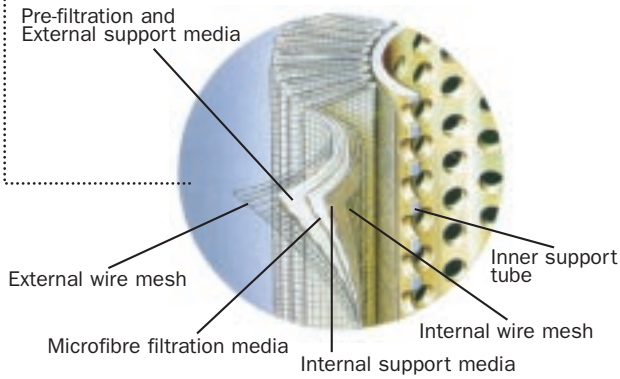

MP Filter elements - Conform to the following ISO standards

- ISO 2941 - Verification of collapse/burst resistance.
- ISO 2942 - Verification of fabrication integrity and determination of the first bubble point.
- ISO 2943 - Verification of material compatibility with fluids.
- ISO 3723 - Method for end load test.
- ISO 3724 - Verification of flow fatigue characteristics.
- ISO 3968 - Evaluation of pressure drop versus flow characteristics.
- ISO 16889 - Multi-pass method for evaluating filtration performance.

Element material Absolute filtration

A Series

Inorganic microfibre with acrylic support

Contamination retention

as per ISO 16889: Multi-pass test.

New improved $\beta \geq 75$ filter elements with greater efficiency and increased dirt holding capacity

Filter elements	Dimensions for β (μm) values				Filtration ratios			ΔP (psi)
	$\beta \geq 2$ (50%)	$\beta \geq 20$ (95%)	$\beta \geq 75$ (98,7%)	$\beta \geq 200$ (99,5%)	β_2	β_{10}	β_{20}	
A03	-	2	2,4	3	20	> 10.000	> 10.000	100
A06	-	3	4,6	6	8	> 2.000	> 10.000	100
A10	3	6	7,8	10	1,5	≥ 200	> 10.000	100
A25	13	19	22	25	-	> 1,5	> 35	100

N.B. Other materials giving different degrees of filtration are available on request.

Filtering area Filter elements

Type CS-CSG-CT	050	070	100	150
A03/A06	300	500	620	840
A10/A25	300	500	620	840

Values in in^2

Element material Nominal filtration

P Series

Resin - impregnated paper

M Series

Square wire mesh (filtration degree is defined in microns by the maximum diameter of a sphere corresponding to the mesh size)

Filtering area Filter elements

Type CS-CSG-CT	050	070	100	150
P10/P25	380	650	670	900
M25	160	200	310	375
M60	160	200	310	375
M90	160	200	310	375

Values in m^2

CSGW Series

Resin - impregnated paper

Type CSGW	050	150
P10/P25	310	475

Materials	Head Aluminium	Bypass valve Nylon
	Seals A Series: Nitrile (Buna-N) V Series: Viton	Indicator Brass
Working temperature	From -13 to +230°F For temperatures outside this range, please consult our Sales Network Organization	
Pressure filter body	Maximum working pressure up to	175 psi
Collapse pressure filter elements		60 psi
Bypass valve Calibration pressure	Bypass valve, differential opening pressure:	S series: 4,0 psi ± 10% (MPS series only) R series: 25 psi ± 10%
Types of indicators for MPS series "0" (MPS 050-070-100...) and MST series		
	Description: MPS series filters are fitted with indicators switching: Suction filters at a pressure of: 3 psi ± 10% Line filters at a pressure of: 18 psi ± 10% (MPS series only) Return filter at a pressure of: 18 psi ± 10% (MPS-MST series only)	
Visual indicator	Suction filter: (MPS series only) VS vacuum switch	scale 0 - 30 in Hg
	Return and line filter VR colour coded pressure gauge	scale 0 - 30 psi
Electrical indicator	Suction filter (MPS series only) "E0" Vacuum switch with change over contact	Operational information: Switching at 3 psi ± 10% Max voltage: 250V 50÷60 Hz Max current: 5 A resistive, 2 A inductive Protection degree IP65
	Return filter ER Pressure switch with N.O. contacts EC Pressure switch with N.C. contacts	Switching at 18 psi ± 10% Max voltage: 48V 50÷60 Hz Max current: 0,5A resistive 0,2A inductive
Types of indicators for MPS series "1" (MPS 051-071-101-151-301-351)		
	MPS filter series 1 (051-071-101... and so on) are fitted with, differential style indicators.	
Visual indicator	1V - Z1 Series for Filter with bypass set to 25 psi	switching at 18 psi ± 10%
	V6 - Z6 Series for Filter without bypass	switching at 30 psi ± 10%
Electrical indicator	N1 Series for Filter with bypass set to 25 psi	switching at 18 psi ± 10%
	N6 Series for Filter without bypass	switching at 30 psi ± 10%
Visual-electrical indicator	1E - K1* Series for Filter with bypass set to 25 psi	switching at 18 psi ± 10%
	E6 - K6* Series for Filter without bypass	switching at 30 psi ± 10%
	*For K visual-electrical indicator, specify the voltage (il. K61 = LED: 24 volt)	

* { 1 - 24 Volt
2 - 115 Volt
3 - 230 Volt

Pressure differential indicator option

K - E - N Series

Supply voltage (50/60 Hz) (V)	Resistive load (A)	Inductive load (A)
Vca 125	5	2
Vca 250	5	2
Vcc 30	5	3
Vcc 125	0,5	0,03
Vcc 250	0,25	0,03

CONNECTOR DIN 43650

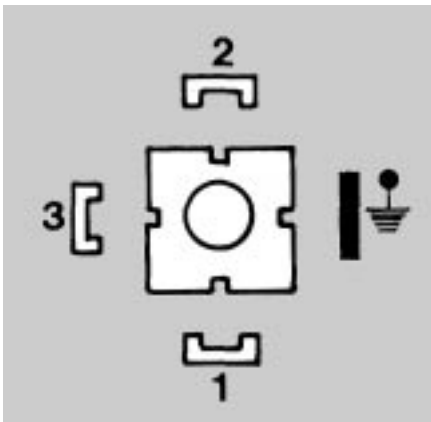

ELECTRICAL CONNECTION E - N SERIES

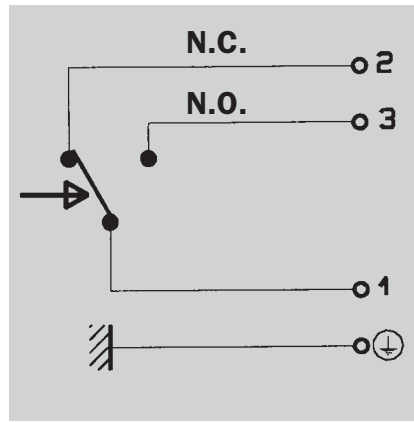

ELECTRICAL CONNECTION K SERIES

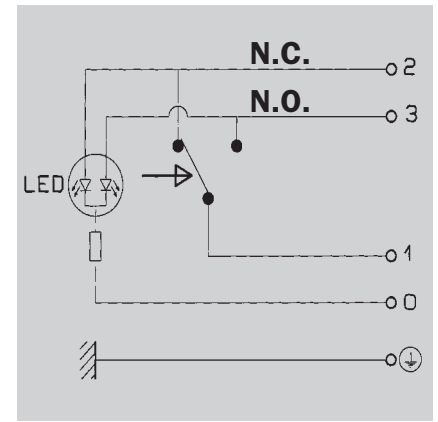

Visual V series

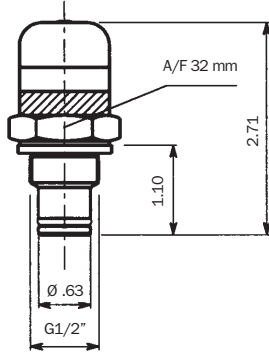

Visual Z series

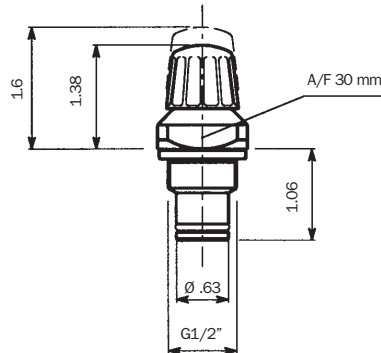

Electrical N series

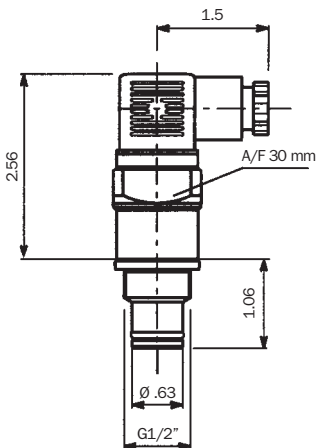

Visual led - Electrical K series

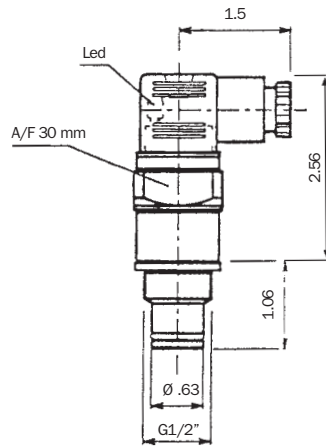

Visual - Electrical E series

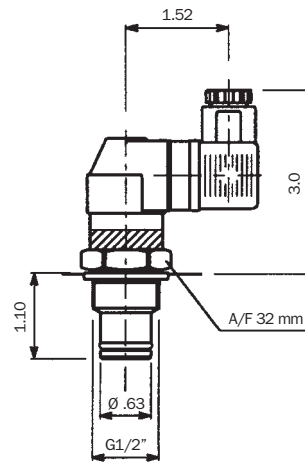

Fluid

Compatibility

Filter head and bowls

compatible for use with:

- mineral oils
(types HH-HL-HM-HR-HV-HG as per ISO 6743/4)
- water-based emulsions
(types HFAE-HFAS as per ISO 6743/4)
- synthetic fluids
(types HS-HFDR-HFDS-HFDU as per ISO 6743/4)
- water-glycol (types HFC as per ISO 6743/4)

Seals

A Series

Nitrile (Buna-N) compatible with mineral oils
(types HH-HL-HM-HR-HV-HG as per ISO 6743/4)

water-based emulsions

(types HFAE-HFAS as per ISO 6743/4)

water - glycol (types HFC as per ISO 6743/4)

V Series

Viton compatible with synthetic fluids

(types HS-HFDR-HFDS-HFDU as per ISO 6743/4)

Filter elements

As per ISO 2943; suitable for mineral oils

(types HH-HL-HM-HR-HV-HG as per ISO 6743/4)

and synthetic fluids (A and M series only)

(types HS-HFDR-HFDS-HFDU as per ISO 6743/4)

For water-based emulsions (types HFAE-HFAS as per ISO 6743/4) and fluids other than those mentioned, please consult our Sales Network Organization.

International standards for contamination fluid control

A general (no direct) comparison between ISO 4406 and NAS 1638 is given in table below.

Contamination codes ISO 4406			Correspondent codes NAS 1638	Recommended filtration degree	Typical applications
<i>4µm(c)</i>	<i>6µm(c)</i>	<i>14µm(c)</i>		<i>B x ≥ 75</i>	
14	12	9	3	3	High precision and laboratory servo-systems
17	15	12	6	3-6	Robotic and servo-systems
18	16	13	7	10-12	Very sensitive - high reliability systems
20	18	15	9	12-15	Sensitive - reliable systems
21	19	16	10	15-25	General equipment of limited reliability
23	21	18	12	25-40	Low - pressure equipment not in continuous service

Selection & installation information

Filter elements A Series

types

Absolute inorganic microfibre filtration media, available in 3, 6, 10 and 25 micron
Example - **A03, A06, A10** or **A25**

P Series

Nominal cellulose impregnated paper media, available in 10 and 25 micron.
Example - **P10** or **P25**

M Series

Metal mesh media, available in 25, 60, and 90 micron.
Example - **M25, M60** or **M90**.

Please refer to individual pressure drop curves to obtain filter assembly pressure drop information

The following filter sizing recommendations are based using a mineral oil fluid at 150 SUS with a maximum total filter assembly (housing and filter element) pressure drop of 30% of the filter condition indicator (6 psi) for line and return filter and 1.15 psi for suction filter.

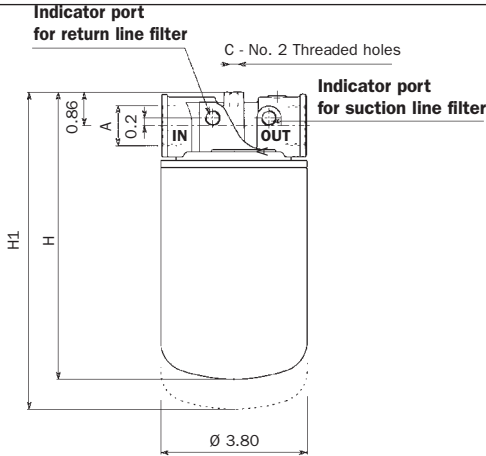

Lengths

Type	H	H1
050-051	7.08	7.87
070-071	9.76	10.55

050-051 MPS 070-071

MPS SERIES 050-051 SIZES

Filter assembly	Line Flow rate gpm *	Suction Flow rate gpm *	Port size BSP/NPT/SAE	Weight lbs **
A03	10.5	2.3	SEE TABLE BELOW	2,2
A06	11.6	2.9		
A10	12.7	3.7		
A25	15.3	4.7		
P10	14.5	4.2		
M60-M90	-	6.3		

MPS SERIES 070-071 SIZES

Filter assembly	Line Flow rate gpm *	Suction Flow rate gpm *	Port size BSP/NPT/SAE	Weight lbs **
A03	12.0	2.9	SEE TABLE BELOW	2,9
A06	13.0	3.4		
A10	14.0	4.0		
A25	16.7	5.3		
P10	15.3	4.7		
M60-M90	-	6.9		

MPS 050-070 Series

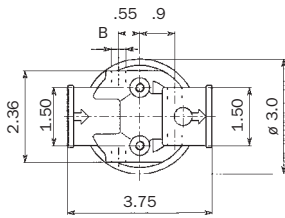

MPS 051-071 Series

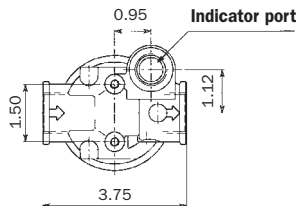

Indicator for suction filter MPS 050-070 (only for option G2-G3-G4-G6)

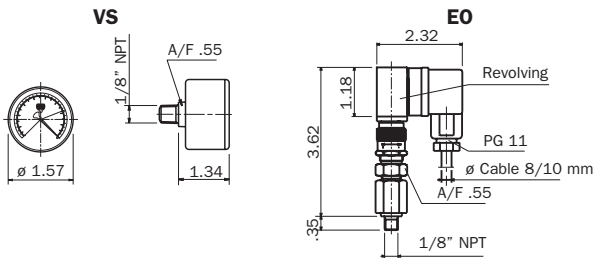

Thread connections

Type	A	B	C
G1	3/4" BSP	1/8" BSP	M6
G2	3/4" NPT	1/8" NPT	1/4" UNC
G3	SAE 12 - 1 1/16" - 12 UN	1/8" NPT	1/4" UNC
G4	SAE 8 - 3/4" - 16 UNF	1/8" NPT	1/4" UNC
G5	1" BSP	1/8" BSP	M6
G6	1" NPT	1/8" NPT	1/4" UNC

Indicator for return filter MPS 050-070 (only for option G2-G3-G4-G6)

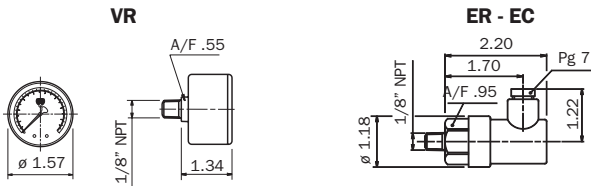

Indicator for line filter MPS 051-071

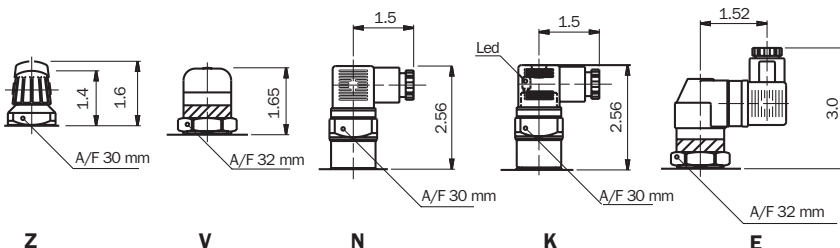

Suction filter - Housing pressure drop

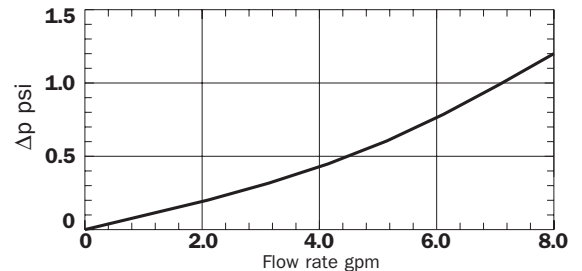

Return line filter - Housing pressure drop

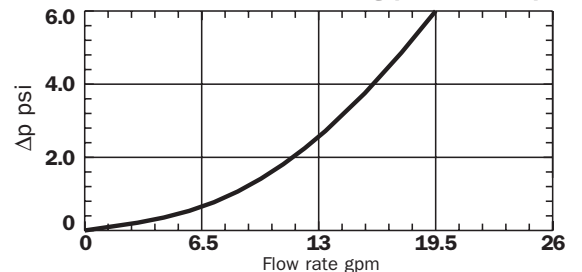

Selection & installation information

Please refer to individual pressure drop curves to obtain filter assembly pressure drop information

The following filter sizing recommendations are based using a mineral oil fluid at 150 SUS with a maximum total filter assembly (housing and filter element) pressure drop of 30% of the filter condition indicator (6 psi) for line and return filter and 1.15 psi for suction filter.

Indicator port
for return line filter

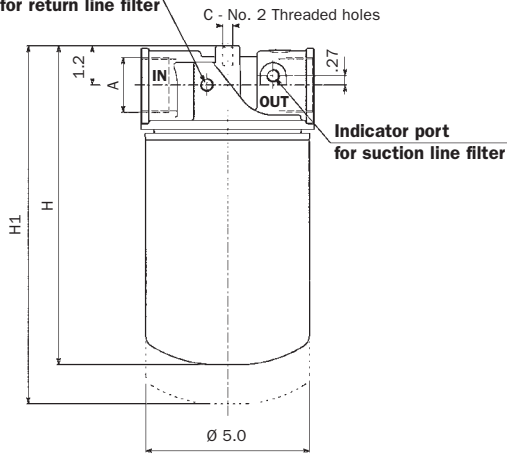

MPS 100-101
150-151

Lengths

Type	H	H1
100-101	9.48	11.50
150-151	11.26	12.25

MPS 100-150 Series

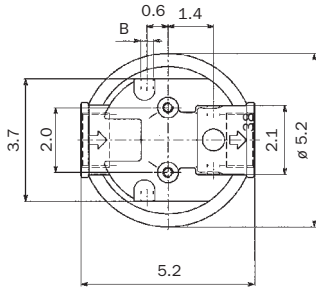

MPS 101-151 Series

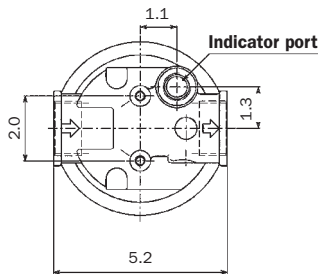

MPS SERIES 100-101 SIZES

Filter assembly	Line Flow rate gpm *	Suction Flow rate gpm *	Port size BSP/NPT/SAE	Weight lbs **
A03	19.8	4.2	1 1/4"	4.88
A06	22.5	5.0		
A10	29.0	6.6		
A25	37.0	10.5		
P10	34.0	9.2		
M60-M90	-	17.0		

MPS SERIES 150-151 SIZES

Filter assembly	Line Flow rate gpm *	Suction Flow rate gpm *	Port size BSP/NPT/SAE	Weight lbs **
A03	22.5	4.7	1 1/4"	5.10
A06	26.4	5.8		
A10	30.4	7.9		
A25	42.3	11.9		
P10	37.0	10.5		
M60-M90	-	18.0		

* Flow rates with 150 SUS fluid viscosity
** Weight including filter element

Indicator for suction filter MPS 100-150 (only for option G2-G3)

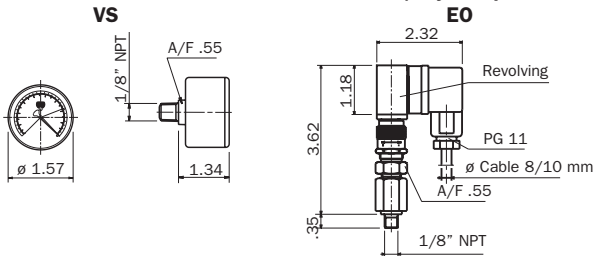

Thread connections

Type	A	B	C
G1	1 1/4" BSP	1/8" BSP	M8
G2	1 1/4" NPT	1/8" NPT	5/16" UNC
G3	SAE 20 - 1 5/8" - 12 UN	1/8" NPT	5/16" UNC

Suction filter - Housing pressure drop

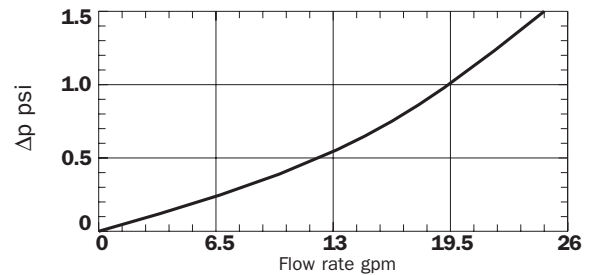

Indicator for return filter MPS 100-150 (only for option G2-G3)

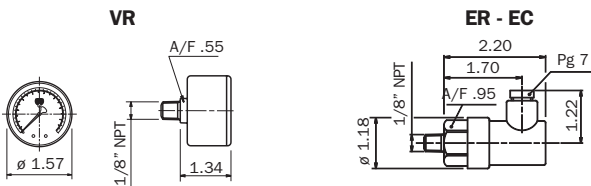

Return line filter - Housing pressure drop

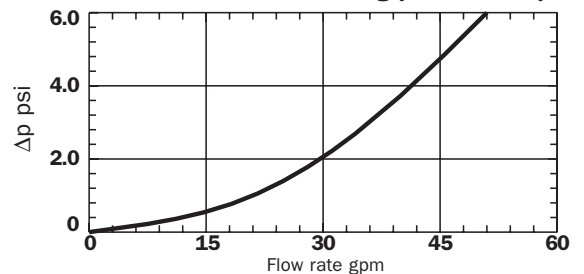

Indicator for line filter MPS 101-151

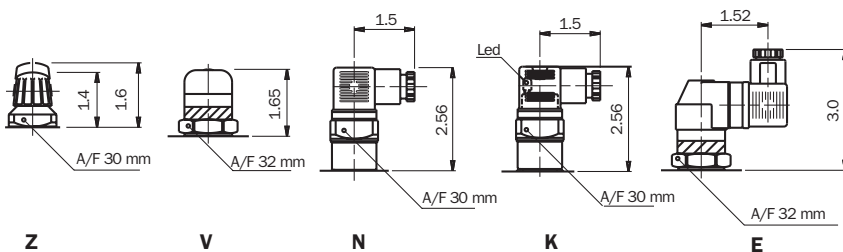

Selection & installation information

Please refer to individual pressure drop curves to obtain filter assembly pressure drop information

The following filter sizing recommendations are based using a mineral oil fluid at 150 SUS with a maximum total filter assembly (housing and filter element) pressure drop of 30% of the filter condition indicator (6 psi) for line and return filter and 1.15 psi for suction filter.

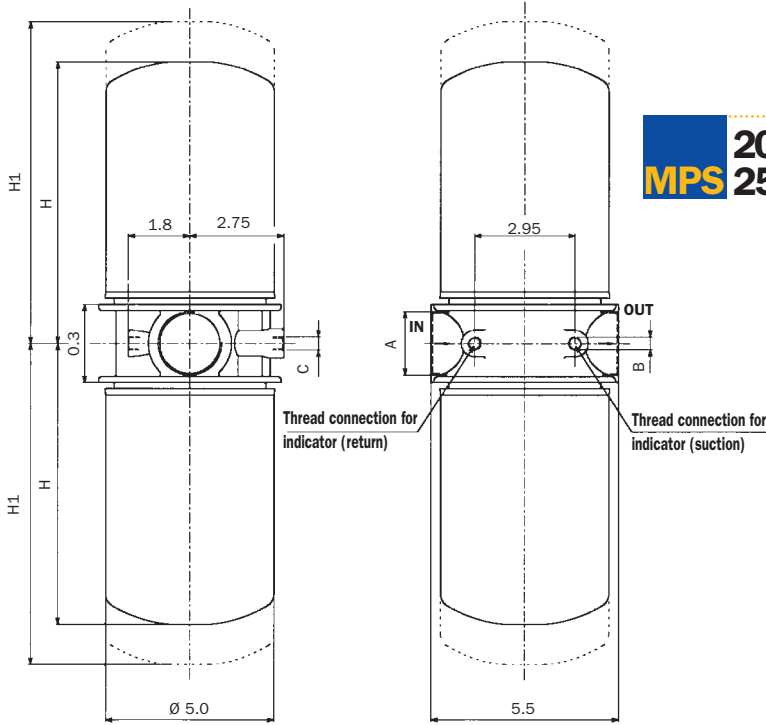

MPS 200
MPS 250

MPS SERIES 200 SIZES

Filter assembly	Line Flow rate gpm *	Suction Flow rate gpm *	Port size BSP/NPT/SAE	Weight lbs **
A03	34.3	7.9	1 1/2"	8.90
A06	45.0	11.9		
A10	58.0	17.0		
A25	76.7	29.0		
P10	71.4	26.4		
M60-M90	-	31.7		

MPS SERIES 250 SIZES

Filter assembly	Line Flow rate gpm *	Suction Flow rate gpm *	Port size BSP/NPT/SAE	Weight lbs **
A03	47.6	13.2	1 1/2"	9.35
A06	55.5	15.8		
A10	66.0	21.0		
A25	82.0	33.0		
P10	74.0	31.2		
M60-M90	-	34.3		

* Flow rates with 150 SUS fluid viscosity
** Weight including filter element

Lengths

Type	H	H1
200	8.50	9.50
250	10.27	11.26

Thread connections

Type	A	B	C
G1	1 1/2" BSP	1/8" BSP	M10
G2	1 1/2" NPT	1/8" NPT	3/8" UNC
G3	SAE 24 - 1 7/8" - 12 UN	1/8" NPT	3/8" UNC

Indicator for suction filter (only for option G2-G3)

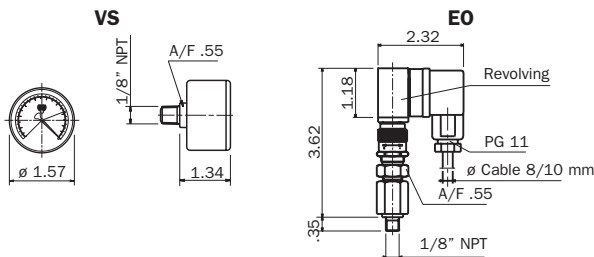

Suction filter - Housing pressure drop

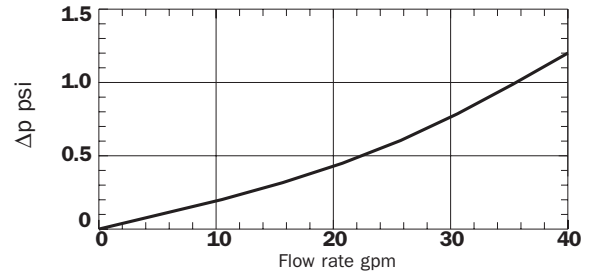

Indicator for return filter (only for option G2-G3)

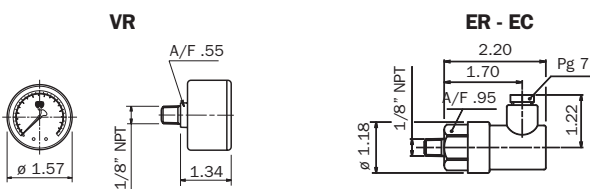

Return line filter - Housing pressure drop

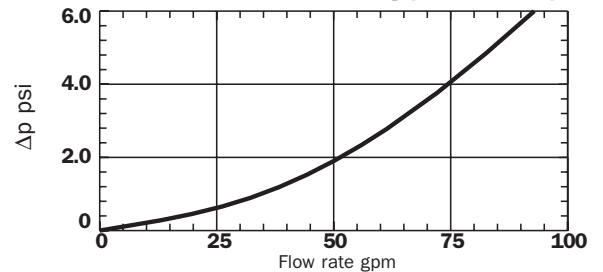

Selection & installation information

Please refer to individual pressure drop curves to obtain filter assembly pressure drop information

The following filter sizing recommendations are based using a mineral oil fluid at 150 SUS with a maximum total filter assembly (housing and filter element) pressure drop of 30% of the filter condition indicator (6 psi) for line and return filter and 1,15 psi for suction filter.

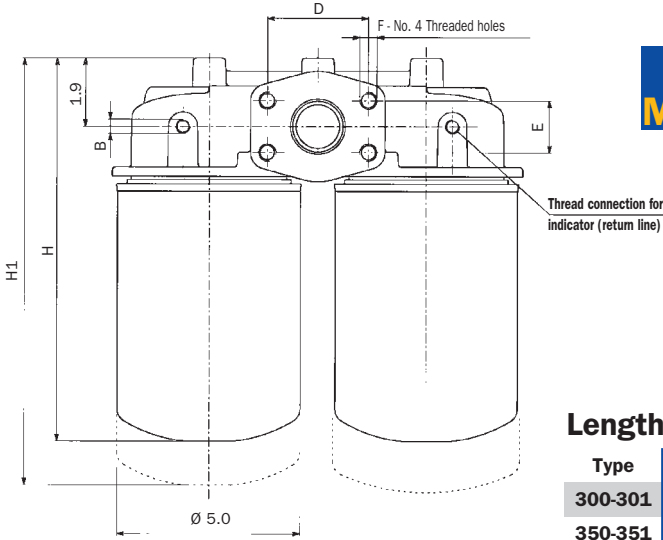

MPS 300-301
MPS 350-351

MPS SERIES 300-301 SIZES

Filter assembly	Line Flow rate gpm *	Suction Flow rate gpm *	Port size BSP/NPT/SAE	Weight lbs **
A03	34.4	7.9	1 1/2"	12.0
A06	45.0	11.9		
A10	58.2	17.0		
A25	76.7	29.0		
P10	71.4	26.4		
M60-M90	-	31.7		

Lengths

Type	H	H1
300-301	10.45	11.42
350-351	12.20	13.20

MPS SERIES 350-351 SIZES

Filter assembly	Line Flow rate gpm *	Suction Flow rate gpm *	Port size BSP/NPT/SAE	Weight lbs **
A03	47.6	13.2	1 1/2"	12.5
A06	55.5	15.8		
A10	66.0	21.0		
A25	82.0	33.0		
P10	74	31.2		
M60-M90	-	34.3		

* Flow rates with 150 SUS fluid viscosity
** Weight including filter element

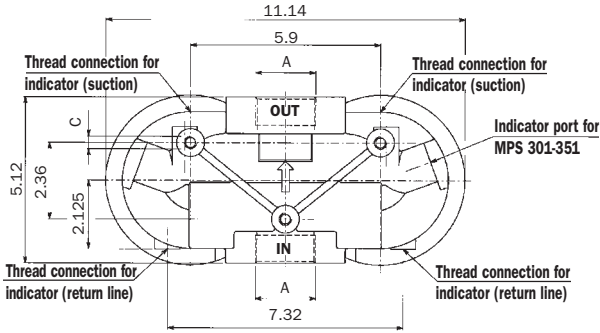

Thread connections

Type	A	B	C
G1	1 1/2" BSP	1/8" BSP	M10
G2	1 1/2" NPT	1/8" NPT	3/8" UNC
G3	SAE 24 - 1 7/8" - 12 UN	1/8" NPT	3/8" UNC

Indicator for suction filter MPS 300-350 (only for option G2-G3-F2)

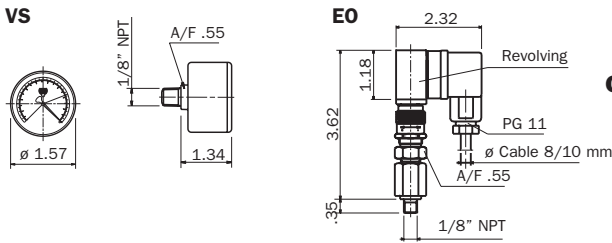

Flange connections

Type	A	B	C	D	E	F
F1	1 1/2" SAE 3000 PSI/M	1/8" BSP	M12	2.75	1.406	M12
F2	1 1/2" SAE 3000 PSI/UNC	1/8" NPT	1/2" UNC	2.75	1.406	1/2" UNC

Indicator for return filter MPS 300-350 (only for option G2-G3-F2)

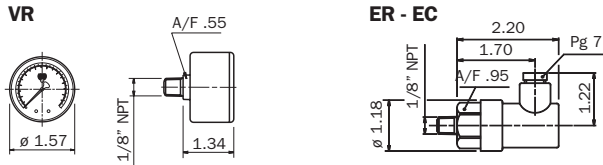

Indicator for line filter MPS 301-351

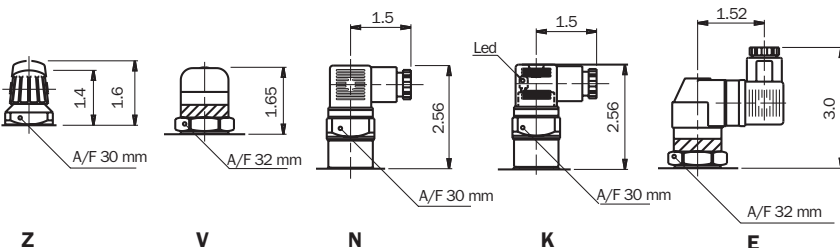

Suction filter - Housing pressure drop

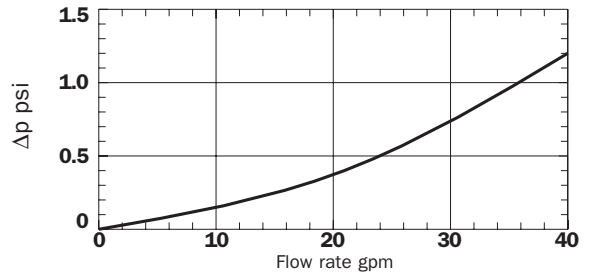

Return line filter - Housing pressure drop

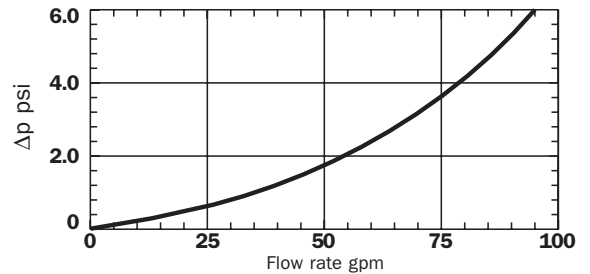

FILTER ELEMENT SERIES -

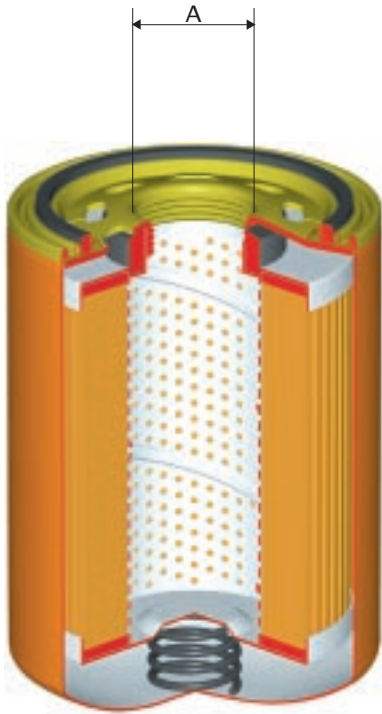

CS

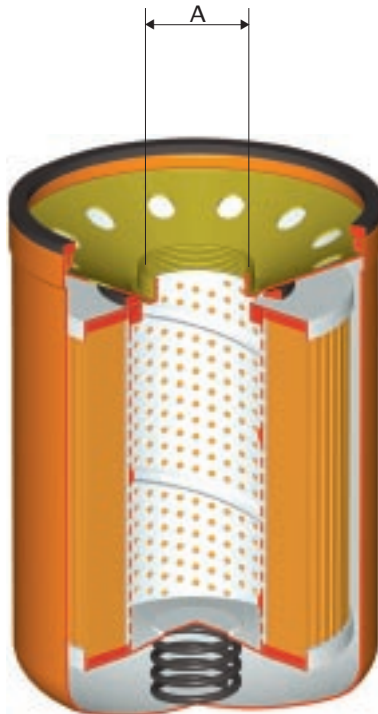

CSG

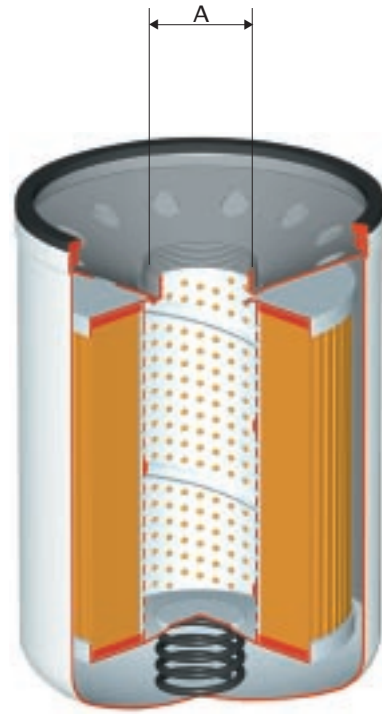

CSGW

New

absolute filter elements
independently tested
in the following Institutes:

Thread connections

Type	A
CS 050-070	3/4" BSP
CS 100-150	1 1/4" BSP

Type	A
CSG 050-070	1" - 12 UN
CSG 100-150	1 1/2" - 16 UN

Type	A
CSGW 050	1" - 12 UN
CSGW 150	1 1/2" - 16 UN

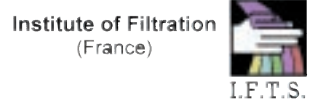

Description

MST - Suitable for installation on return lines, mounted tank top where the flow does not exceed 350 l/min.
MST use spin-on canisters incorporating a bypass valve.
To avoid oil leaks during maintenance, the canisters have a special anti-drain membrane.
MST - filter is ideal for machine tool and agricultural applications.

New

absolute filter elements
independently tested
in the following Institutes:

Institute of Filtration
(France)
I.F.T.S.

KUNGL. TEKNISKA
HÖGSKOLAN
Royal Institute of Technology

UNI EN ISO 9001
N° 037/98
ITALCERT

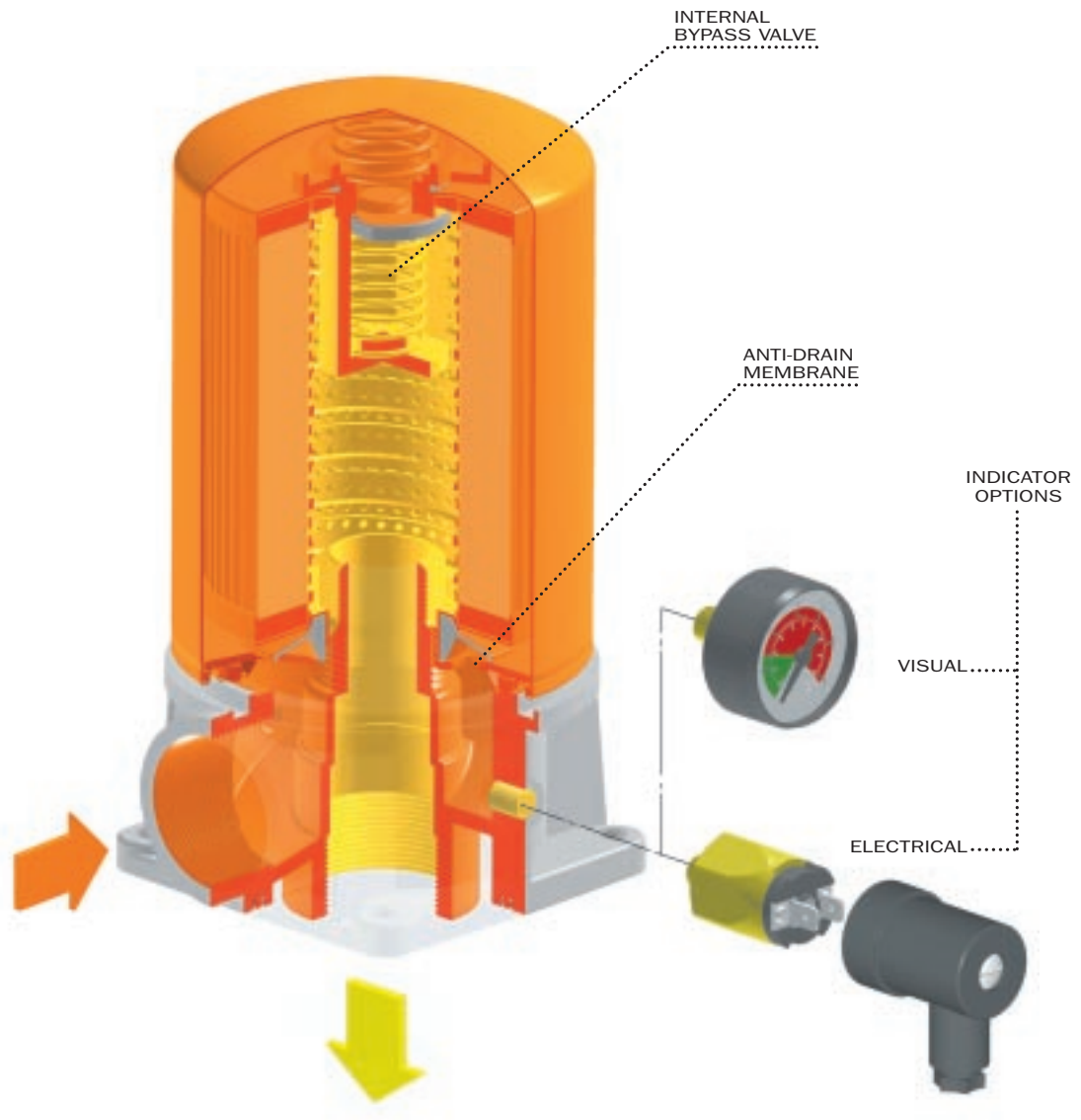

Selection & installation information

Filter elements **A Series**

types

Absolute inorganic microfibre filtration media, available in 3, 6, 10 and 25 micron
Example - **A03, A06, A10** or **A25**

P Series

Nominal cellulose impregnated paper media, available in 10 and 25 micron.
Example - **P10** or **P25**

M Series

Metal mesh media, available in 25, 60, and 90 micron.
Example - **M25, M60** or **M90**.

Please refer to individual pressure drop curves to obtain filter assembly pressure drop information

The following filter sizing recommendations are based using a mineral oil fluid at 150 SUS with a maximum total filter assembly (housing and filter element) pressure drop of 30% of the filter condition indicator (6 psi) for line and return filter.

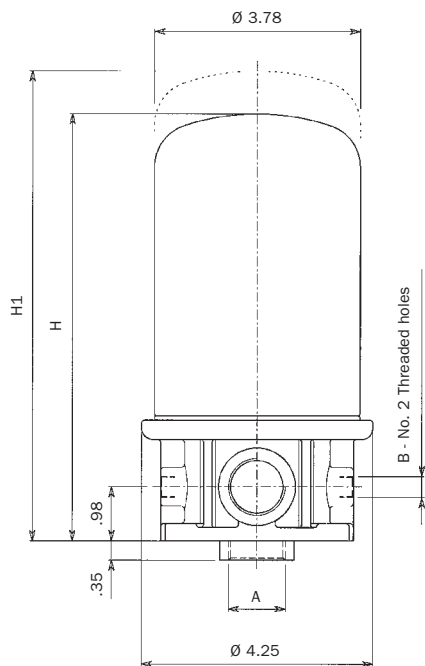
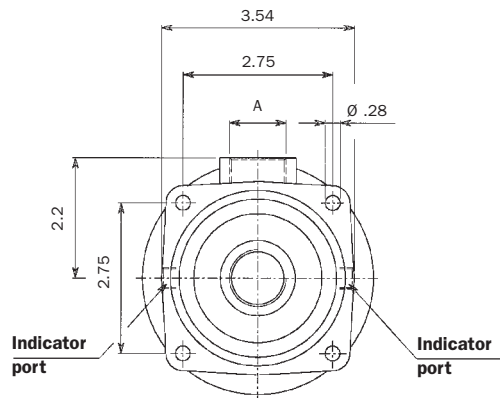

Indicator (only for option G2-G3)

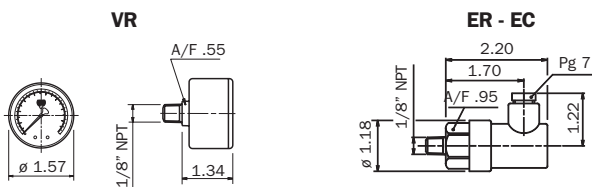

MST SERIES 050 SIZES

MST 050-070

Filter assembly	Line Flow rate gpm *	Port size BSP/NPT/SAE	Weight lbs **
A03	11.0	3/4"	2.66
A06	13.2		
A10	17.0		
A25	19.8		
P10	18.0		

MST SERIES 070 SIZES

Filter assembly	Line Flow rate gpm *	Port size BSP/NPT/SAE	Weight lbs **
A03	14.5	3/4"	3.35
A06	15.8		
A10	18.0		
A25	21.0		
P10	20.0		

* Flow rates with 150 SUS fluid viscosity
** Weight including filter element

Thread connections

Type	A	B
G1	3/4" BSP	1/8" BSP
G2	3/4" NPT	1/8" NPT
G3	SAE 8 - 3/4" - 16 UNF	1/8" NPT

Lengths

Type	H	H1
050	7.48	8.20
070	10.43	11.15

Housing pressure drop

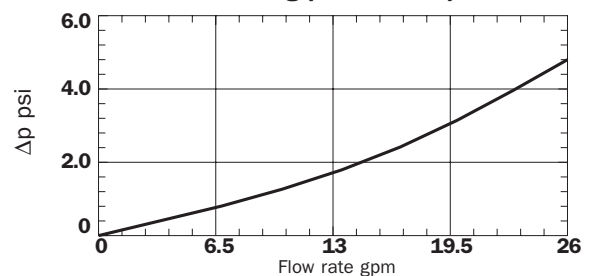

Selection & installation information

Please refer to individual pressure drop curves to obtain filter assembly pressure drop information

The following filter sizing recommendations are based using a mineral oil fluid at 150 SUS with a maximum total filter assembly (housing and filter element) pressure drop of 30% of the filter condition indicator (6 psi) for line and return filter.

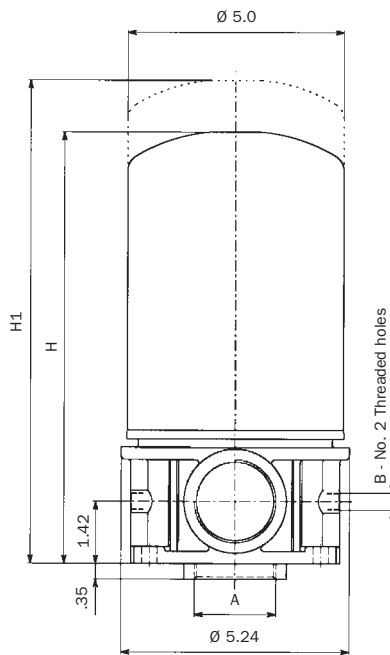
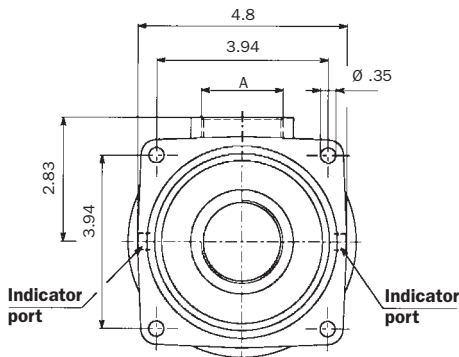

Indicator (only for option G2-G3)

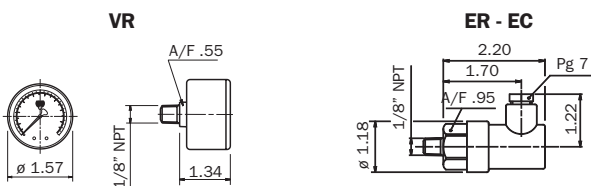

MST 100-150

MST SERIES 100 SIZES

Filter assembly	Line Flow rate gpm *	Port size BSP/NPT/SAE	Weight lbs **
A03	21.0	1 1/2"	5.2
A06	23.8		
A10	33.0		
A25	49.0		
P10	46.3		

MST SERIES 150 SIZES

Filter assembly	Line Flow rate gpm *	Port size BSP/NPT/SAE	Weight lbs **
A03	23.8	1 1/2"	5.4
A06	29.0		
A10	37.0		
A25	55.5		
P10	50.3		

* Flow rates with 150 SUS fluid viscosity
** Weight including filter element

Thread connections

Type	A	B
G1	1 1/2" BSP	1/8" BSP
G2	1 1/2" NPT	1/8" NPT
G3	SAE 20 - 1 5/8" - 12 UNF	1/8" NPT

Lengths

Type	H	H1
100	9.84	10.9
150	11.02	12.0

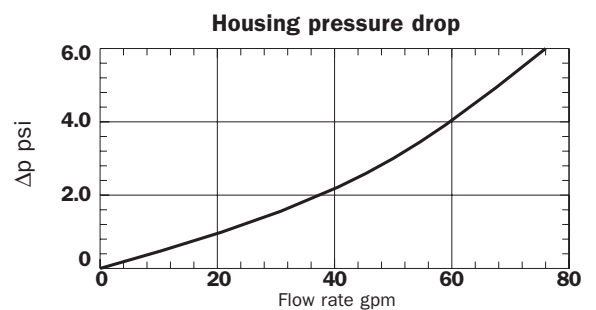

General

Pressure drop versus flow rate curve information for both housing and filter elements is in accordance with ISO 3968

Filter assembly pressure drop - $\Delta p_{\text{Total}} = \Delta p_{\text{Housing}} + \Delta p_{\text{Filter element}}$

Housing pressure drop - The housing pressure drop is proportional to the fluid density

Filter element pressure drop - Filter element pressure drop is proportional to kinematic viscosity therefore always check the fluid operating temperature and fluid type to obtain the working viscosity according to the following formula:

$$\Delta p_1 \text{ Filter element} = (\text{working viscosity} / \text{brochure viscosity}) \times \Delta p \text{ filter element}$$

Brochure viscosity 150 SUS

Filter assembly sizing example

- Customer requires a 26 gpm filter assembly
- Mineral oil fluid: 230 SUS at 104 °F
- 25 micron absolute filtration
- return line application

Selection :

- **Housing pressure drop** - MPS 100/101 with 26 gpm $\Delta p = 1.85$ psi (see curve on page 8)
- **Filter element pressure drop** brochure viscosity - CS100A25 with 26 gpm $\Delta p = 1.3$ psi (see curve on page 17)
- **Filter element pressure drop** working viscosity - With 230 SUS $\Delta p_1 = 1.3 \times (230/150) = 2.0$ psi
- **Filter assembly pressure drop** $\Delta p_{\text{Total}} = \Delta p_{\text{Housing}} + \Delta p_1 \text{ Filter element} = 1.85 + 2.0 = \mathbf{3.85 \text{ psi}^*}$ } Acceptable pressure drop value, as per our recommendations

Bypass valves pressure drop

The curves were obtained using a mineral oil with a density of 0,86
The Δp varies proportionally to the density.

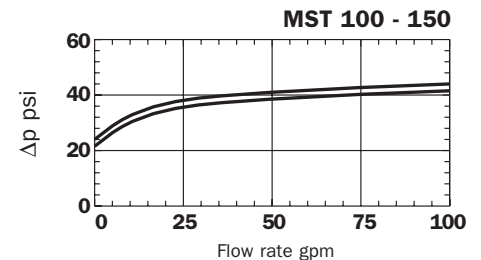
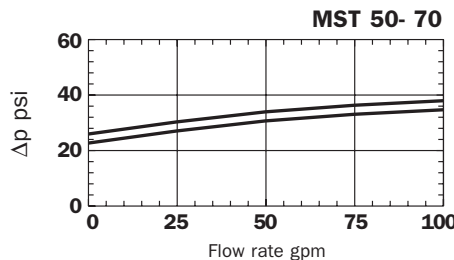
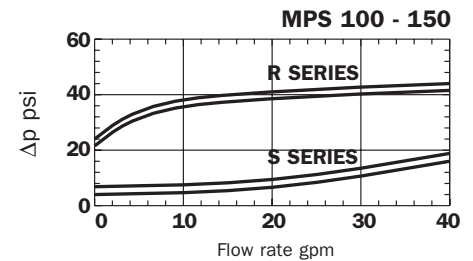
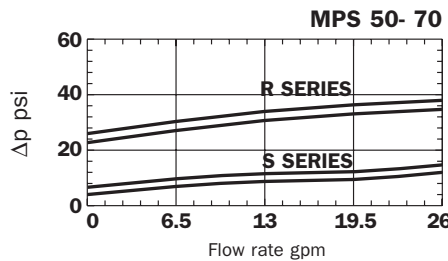

R series: Return filter
S series: Suction filter

SUCTION FILTER

Filter elements - P/M Series

The curves were obtained using a mineral oil with a kinematic viscosity of 150 SUS.
The Δp varies proportionally to the fluid kinematic viscosity.

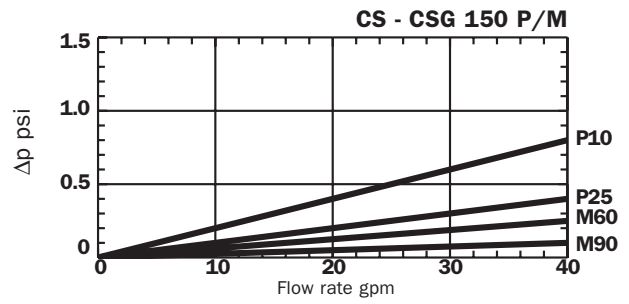
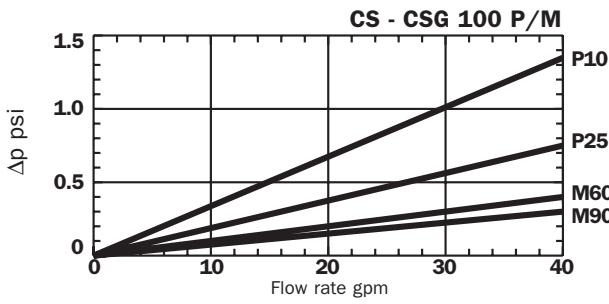
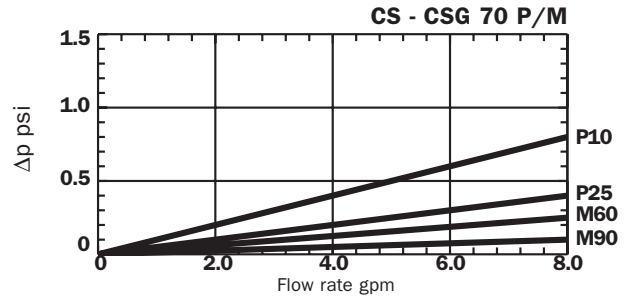
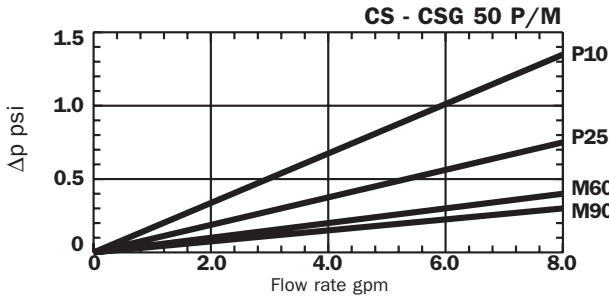

Filter elements - A Series

The curves were obtained using a mineral oil with a kinematic viscosity of 150 SUS.
The Δp varies proportionally to the fluid kinematic viscosity.

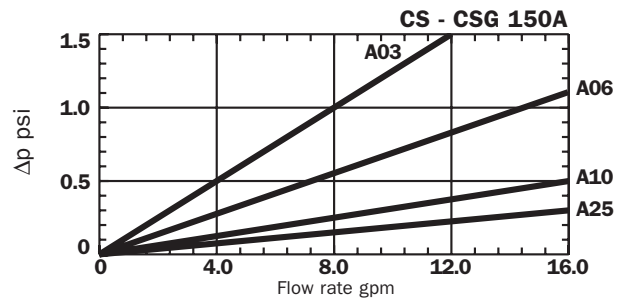
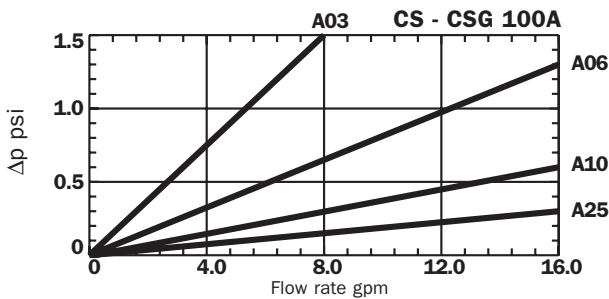
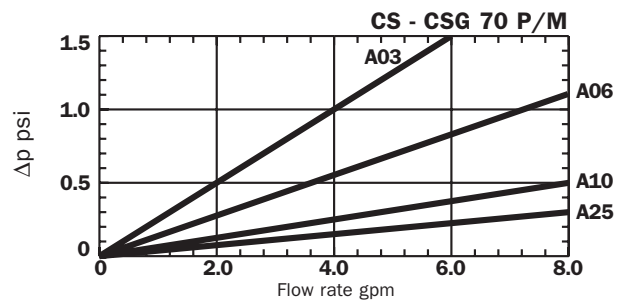
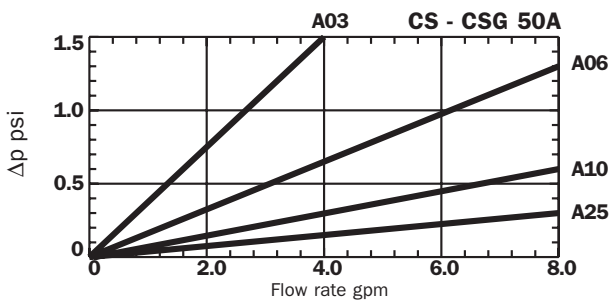

RETURN FILTER

Filter elements - P/M Series

The curves were obtained using a mineral oil with a kinematic viscosity of 150 SUS.
The Δp varies proportionally to the fluid kinematic viscosity.

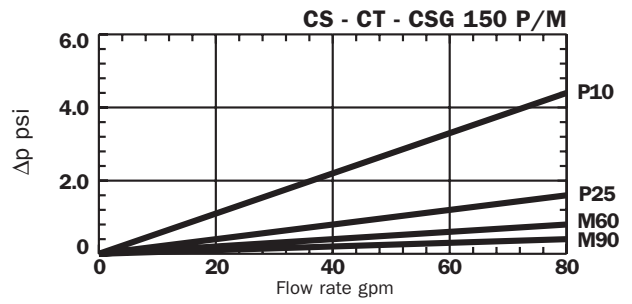
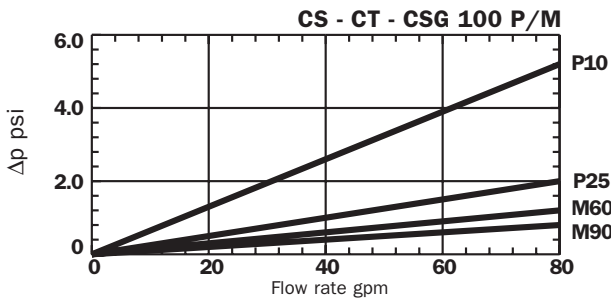
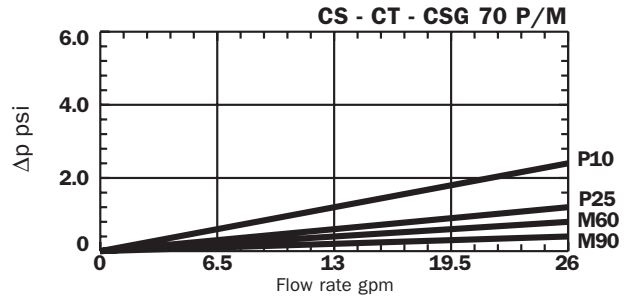
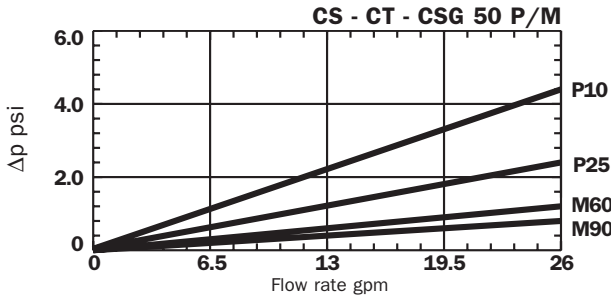

Filter elements - A Series

The curves were obtained using a mineral oil with a kinematic viscosity of 150 SUS.
The Δp varies proportionally to the fluid kinematic viscosity.

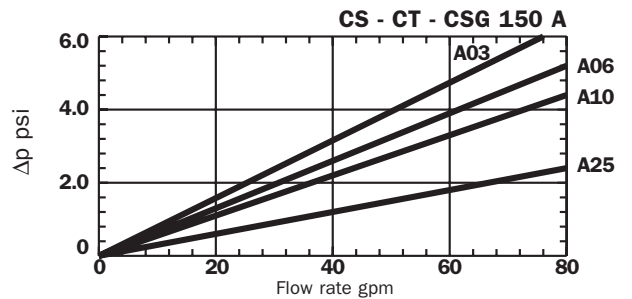
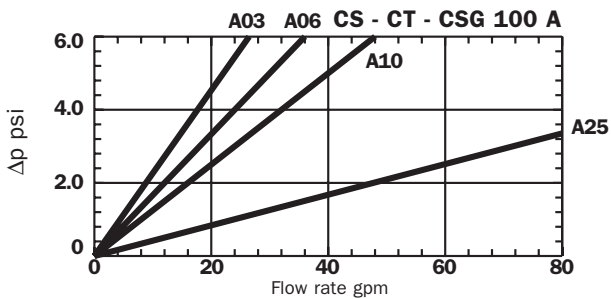
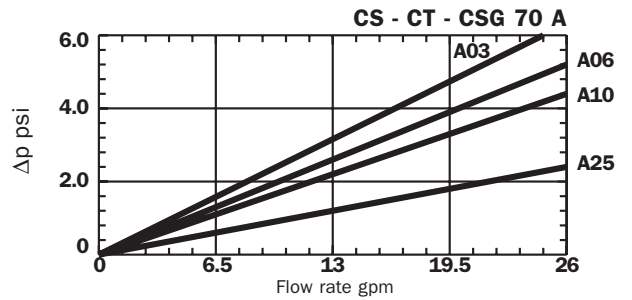
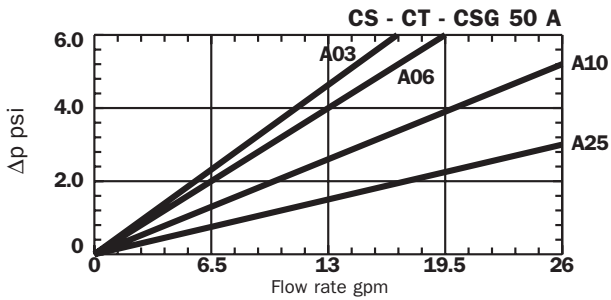

MPS

Nominal sizes

Series 0	Series 1
050	051
070	071
100	101
150	151
200	-
250	-
300	301
350	351

Bypass valve

Filter series "0"	
C	With bypass 25 psi - 4 indicator ports
O	Without bypass with indicator ports on suction
P	Without bypass with indicator ports on return
R	with bypass 25 psi and indicator ports on return
S	With bypass 4.5 psi and indicator ports on suction
U	Without bypass without indicator ports
Filter series "1"	
R	With bypass 25 psi
P	Without bypass

Port options

Type	MPS 050-071	MPS 100-151	MPS 200-250	MPS 300-351
G1	3/4" BSP	1 1/4" BSP	1 1/2" BSP	1 1/2" BSP
G2	3/4" NPT	1 1/4" NPT	1 1/2" NPT	1 1/2" NPT
G3	SAE 12	SAE 20	SAE 24	SAE 24
G4	SAE 8	-	-	-
G5	1" BSP	-	-	-
G6	1" NPT	-	-	-
F1	-	-	-	1 1/2" SAE 3000 Psi/M
F2	-	-	-	1 1/2" SAE 3000 Psi/UNC

G4 Option without bypass only

Series

CS	European std. filter element
CSG	USA standard filter element
CSGW	USA standard filter element (water removal type)

Filter condition indicator

S	With threaded hole only
T	With plug
Indicators for suctions filters (MPS series only)	
VS	Visual vacuum gauge
EO	Electrical vacuum switch exchange contact
Indicators for return filters (for MPS/MST series)	
VR	Colour coded pressure gauge
ER	Pressure switch with N.O. contacts
EC	Pressure switch with N.C. contacts
Differential Indicators for line filters (only for series "1")	
S	With threaded hole only
T2	Plug for indicator port
1V	Visual 15 psi
V6	Visual 30 psi
Z1	Visual 18 psi
Z6	Visual 30 psi
N1	Electrical 18 psi
N6	Electrical 30 psi
1E	Visual-electrical 18 psi
E6	Visual-electrical 30 psi
K1*	Visual-Electrical 18 psi
K6*	Visual-Electrical 30 psi

*For K visual-electrical indicator, specify the voltage (f.i. K61)

Seals

A	Nitrile (Buna - N)
V	Viton

Filter elements M/P series

P10	Resin-impregnated paper $\beta_x \geq 2$
P25	
M25	Square wire mesh
M60	
M90	

Filter elements A series

A03	Inorganic microfibre $\beta_x \geq 75$
A06	
A10	
A25	

Nominal sizes

050	use 1 element for MPS 050-051
070	use 1 element for MPS 070-071
100	use 1 element for MPS 100-101
100	use 2 elements for MPS 200
100	use 2 elements for MPS 300-301
150	use 1 element for MPS 150-151
150	use 2 elements for MPS 250
150	use 2 elements for MPS 300-301

CS

Replacement element

MP Filtri - Filtration products will only be guaranteed if original MP Filtri replacement elements and spares are used

Data held in this publication is given only for indicative purposes. MP Filtri reserves to introduce modifications to described items for technical or commercial reasons. Copyright reserved.

MST

Nominal sizes

050
070
100
150

Seals

A	Nitrile (Buna - N)
V	Viton

Port options

Type	MST 050-070	MST 100-150
G1	3/4" BSP	1 1/2" BSP
G2	3/4" NPT	1 1/2" NPT
G3	SAE 8	SAE 20

Filter elements indicator

S	With threaded hole only
T	With plug
VR	Colour coded pressure gauge
ER	Pressure switch with N.O. contacts
EC	Pressure switch with N.C. contacts

Bypass valve

B	Calibration: 25 psi
---	---------------------

Seals

A	Nitrile (Buna - N)
V	Viton

Filter elements M/P series

P10 P25	Resin-impregnated paper $\beta_x \geq 2$
M25 M60 M90	
Square wire mesh	

Filter elements A series

A03 A06 A10 A25	Inorganic microfibre $\beta_x \geq 75$
--------------------------	--

CT

Replacement element

MP Filtri - Filtration products will only be guaranteed if original MP Filtri replacement elements and spares are used

Data held in this publication is given only for indicative purposes. MP Filtri reserves to introduce modifications to described items for technical or commercial reasons. Copyright reserved.



Head Quarter :

MP FILTRI S.p.A. Italy

Via Matteotti, 2
20060 Pessano con Bornago (Milano) Italy
Tel. ++39.02/95703.1
Fax ++39.02/95741497-95740188
email: sales@mpfiltri.com
<http://www.mpfiltri.com>



GREAT BRITAIN

MP FILTRI U.K. Ltd.

Bourton Industrial Park
Bourton on the Water
Gloucestershire GL54 2HQ UK
Phone: 01451-822522
Fax: 01451-822282
email: sales@mpfiltri.co.uk
<http://www.mpfiltri.co.uk>

GERMANY

MP FILTRI D GmbH

Am Wasserturm 5
D-66265 Heusweiler/Holz
Phone: 06806/85022-0
Fax: 06806/85022-18
email: mpfiltrink@aol.com

U.S.A.:

MP FILTRI U.S.A. Inc.

1256C Oakbrook Drive - Norcross,
Georgia - U.S.A. 30093
Phone: 770-263-0090
Fax: 770-242-4069
email: mpusasales@aol.com

CANADA:

MP FILTRI CANADA Inc.

210 Jacob Keffer Parkway Concord,
Ontario Canada L4K 4W3
Phone: 905-303-1369
Fax: 905-303-7256
email: mail@mpfiltricanada.com
<http://www.mpfiltricanada.com>