



MACRON DYNAMICS, INC.

1-800-MACRON-1 (1-800-622-7661)

460 Caredean Drive · Horsham, PA 19044-1325

215-443-8888 Fax 215-443-0981

macron@macrondynamics.com

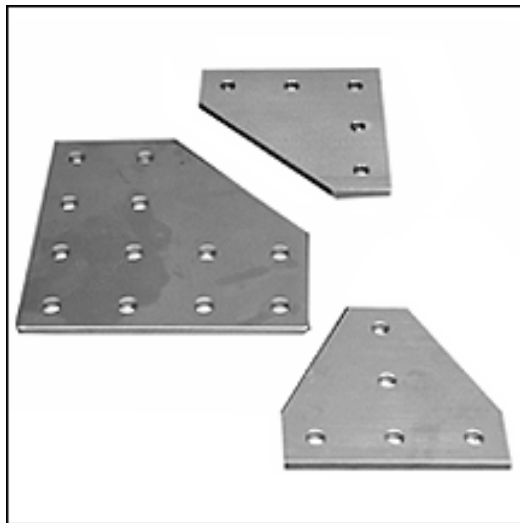
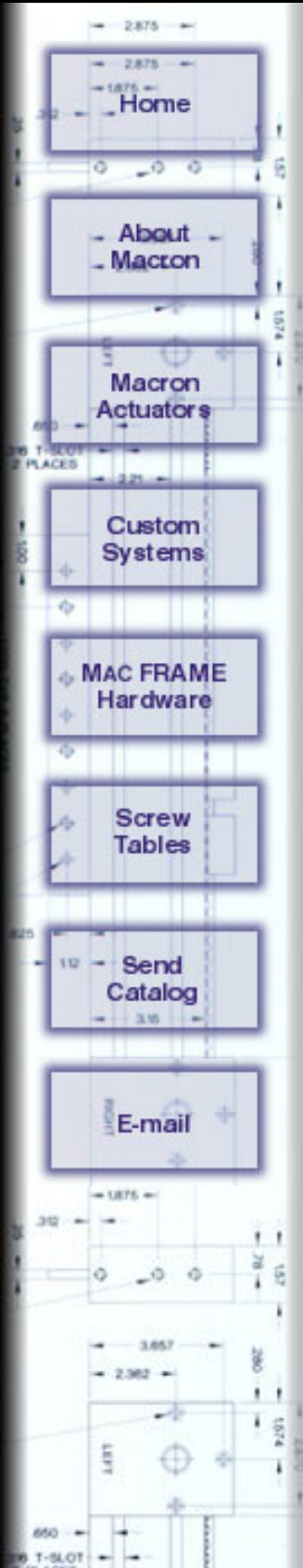

Connecting Plates

PART NO.	DESCRIPTION
M20107	Connecting Plate 40, Sgl.
M20108	Connecting Plate 80, Sgl.
M20109	Corner Connecting Plate, 40 - Five hole
M20110	T-Connecting Plate, 40
M20111	Connecting Plate, 40 Dbl.
M20112	Connecting Plate, 80 Dbl.
M20113	Corner Connecting Plate, 80
M20114	T-Connecting Plate, 80
M20115	Corner Connecting Plate, 40 - Four hole
M20116	Corner Connecting Plate, 40 - Seven hole

Technical Specifications

Material: 6061-T6 Aluminum, .25 thick

Finish: Clear Anodized

Hardware Required: One M20058 and one M8x18 BHCS for each hole

M20107

M20108

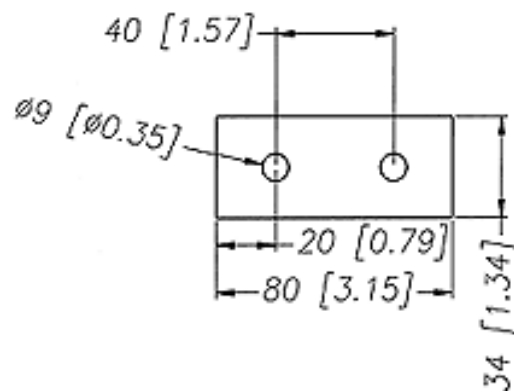

Made In
USA

MACRON DYNAMICS, INC.

[Site Map](#)



MACRON DYNAMICS, INC.

1-800-MACRON-1 (1-800-622-7661)

460 Caredean Drive · Horsham, PA 19044-1325

215-443-8888 Fax 215-443-0981

macron@macrondynamics.com

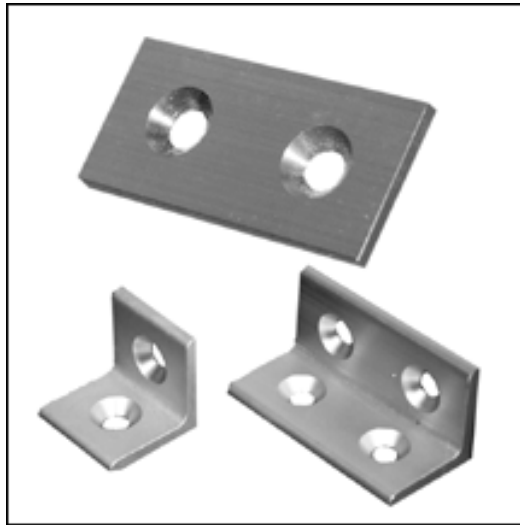
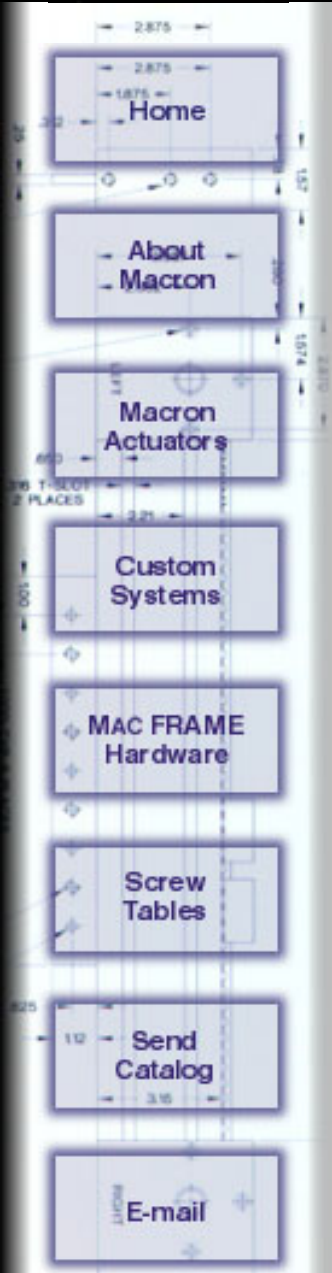

Connecting Bracket

PART NO. DESCRIPTION

- M22140 Flat Bracket, 40
- M22141 Angle Bracket, 40
- M22142 Angle Bracket, 80

Technical Specifications

Material: 6061-T6 Aluminum, 3/16 thick

Finish: Clear Anodized

Fastening Hardware Required: One M20058, M8 T-Slot Nut and one M8x16 FHCS for each hole

**Made In
USA**

MACRON DYNAMICS, INC.

[Site Map](#)



MACRON DYNAMICS, INC.

1-800-MACRON-1 (1-800-622-7661)

460 Caredean Drive · Horsham, PA 19044-1325

215-443-8888 Fax 215-443-0981

macron@macrondynamics.com

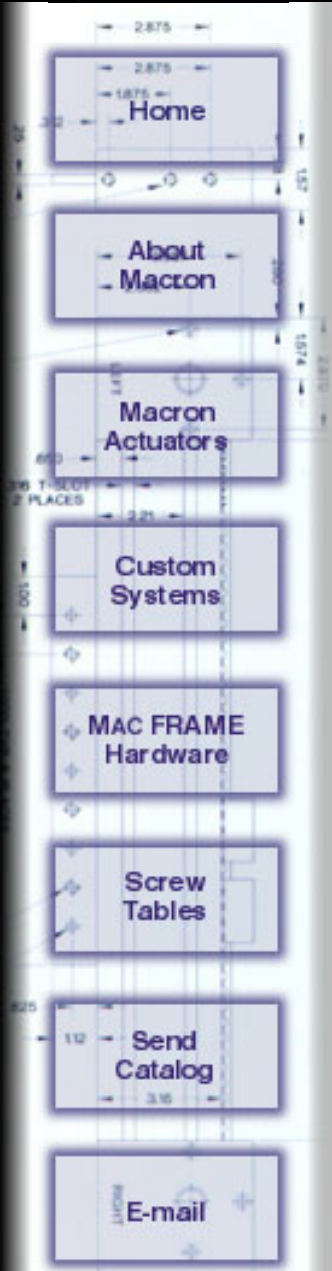

Standard Duty Leveling Foot

PART NO.	DESCRIPTION
M21007	Standard Duty Leveling Foot 1/2-13 Thread

Technical Specifications

Material:	Black Plastic Base, Steel Galvanized Stem & Nut
Maximum Load :	6,677 N (1,500 lbs.) vertical

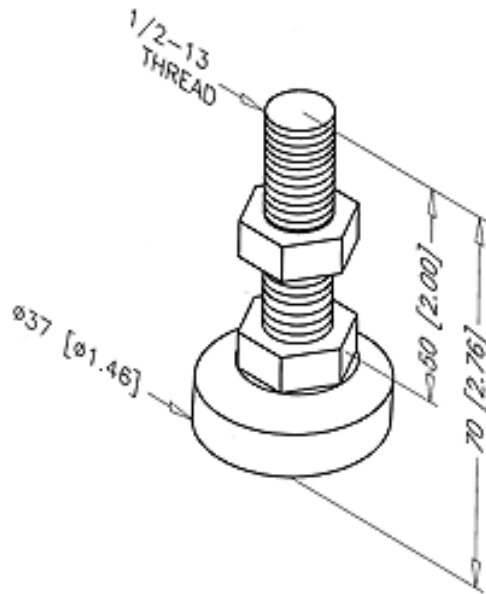

**Made In
USA**

MACRON DYNAMICS, INC.

[Site Map](#)