

CATALOG

valves

140 Series

High Flow, Solenoid Pilot or Pilot Actuated Valves



NUMATICS®

Table of Contents



140 Series	3-6
Technical and Operating Data	3
How to Order	4
Valve on Individual Base	5
Plugging Arrangements	6
Base Assembly Kits	6
Service Kits and Parts	6
Solenoid Capsule Assemblies	6



140 Series

PA single air pilot 2 position 4-way

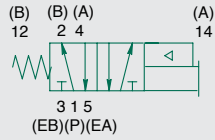

PP double air pilot 2 position 4-way

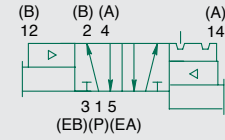

SPA single solenoid pilot 2 position 4-way

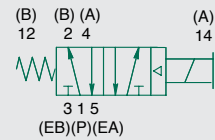

SPA double solenoid pilot 2 position 4-way

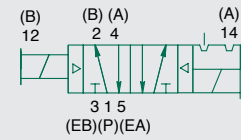

5 Ported, 2 position, 4-way, Spool & Sleeve
Cv: 14.5 - 16.5

- Solenoid pilot or air pilot actuated
- Plug-in solenoid with indicator light
- Unlubricated or lubricated service
- Base with side and bottom ports and individual exhaust
- NEMA4 / IP65



Technical Data

VALVE DATA	1 NPTF	1-1/4 NPTF	1-1/2 NPTF
Cv	14.5	16.0	16.5
Flow capacity	671.5 SCFM	741 SCFM Upstream pressure to atmosphere @80 PSIG	764 SCFM
Pilot Pressure Range: Models 140BA4 and 140PA4	20 to 125 PSIG	20 to 125 PSIG	20 to 125 PSIG
Pilot Pressure Range: Models 140BB4 and 140PP4	15 to 125 PSIG	15 to 125 PSIG	15 to 125 PSIG
Operating Pressure Range: main valve	28" HG. Vacuum to 150 PSIG	28" HG. Vacuum to 150 PSIG	28" HG. Vacuum to 150 PSIG
Temperature Range (ambient)	-10°F to +115°F	-10°F to +115°F	-10°F to +115°F

Operating Data: Solenoid-Pilot

STANDARD VOLTAGES	INRUSH CURRENT (amps)	HOLDING CURRENT (amps)	DC POWER (Watts)	ENERGIZE IN SECONDS	DE-ENERGIZE IN SECONDS
				2-POSITION 140 SOLENOID-PILOT VALVES	2-POSITION 140 SOLENOID-PILOT VALVES
120/60 AC	0.40	0.09	N/A	0.012	0.012
12 VDC	0.50	0.50	6.0 W	0.038	0.012
24 VDC	0.25	0.25	6.0 W	0.038	0.012



140 Series

How to Order

Valves

146 BB 4 3A M 0 000 61

Valve Series & Port Size

- 146 = 1
- 147 = 1-1/4
- 148 = 1-1/2
- 140 = Valve Unit Only

Valve Type

- PA = Single Air Pilot Spring Return
- PP = Double Air Pilot
- BA = Single Solenoid Pilot w/Flush Non-locking Override and Spring Return
- BB = Double Solenoid Pilot w/Flush Non-locking Override

Function

- 4 = 2 Position, 4-Way

Mounting

- 00 = Valve Unit Only
- 3A = Base, Side Ports, Individual Exhaust

Voltage

- 30 = 110-120/50-60 VAC
- 60 = 12 VDC
- 61 = 24 VDC
- 40 = 220-240/50-60 VAC
- 00 = Not Applicable (Air Pilot)

Options

- 11B = Flush Locking Override
- 11Z = Extended Locking Override
- 14X = External Pilot
- 17N = DC Solenoid w/Diode
- 46T = Zinc Plated T Armature

Port Type

- 0 = NPTF

Wiring Option

- K = Std. AC w/Light
- M = Std. DC w/Light
- O = Air Pilot
- 2 = DIN AC w/o Light
- 4 = DIN DC w/o Light



Valve on Individual Base

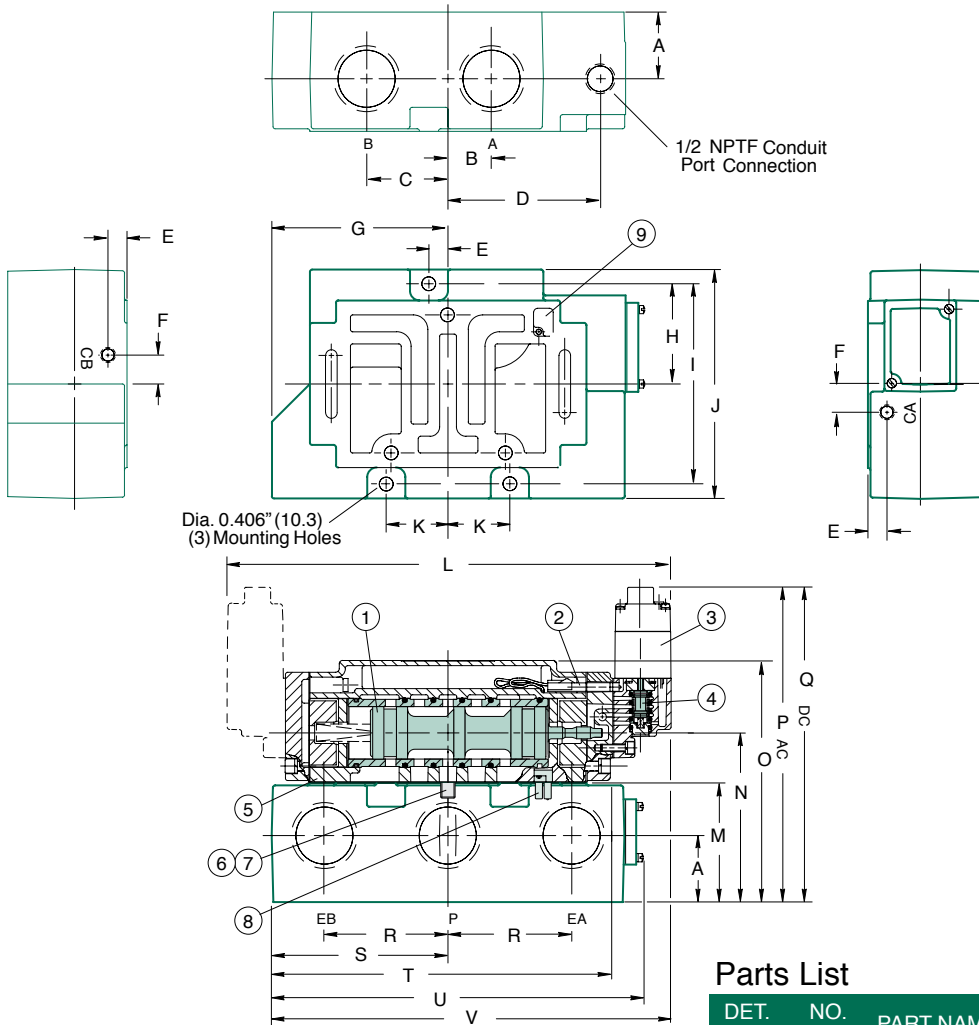

Parts List

DET. NO.	NO. REQ'D	PART NAME	PART NO.
1	1	Valve Sleeve Ass'y w/Seals	209-362
2	*	Gasket: solenoid-pilot air-pilot	113-390 113-395
3	*	Sol-Pilot Ass'y: w/Adaptor w/o Adaptor	202-396 202-384
4	*	Solenoid-Pilot Sleeve Assembly w/Seals	209-207
5	1	Gasket body/base	113-394
6	3	Screw	127-555
7	3	Lockwasher	128-150
8	1	Plug Receptacle - valve	230-427
9	1	Plug Receptacle - base	230-229

* (1) for BA4 models or (2) for BB4 models.

Dimensions

top dimensions = inches and bottom dimensions (in parenthesis) = millimeters

A	B	C	D	E	F	G	H	I	J	K
1.75 (44.4)	1.13 (28.7)	2.13 (54.1)	4.00 (101.6)	0.50 (12.7)	0.75 (19.1)	4.26 (108.2)	2.62 (66.5)	5.25 (133.3)	6.00 (152.4)	1.62 (41.1)
L	M	N	O	P	Q	R	S	T	U	V
11.70 (297.0)	3.13 (79.5)	44.4 (112.8)	6.34 (161.0)	7.93 (201.4)	8.62 (218.9)	3.25 (82.6)	4.62 (117.3)	9.07 (203.4)	9.77 (248.2)	10.47 (266.0)



140 Series

Multi-Purpose Pilot Plugging Arrangements for Solenoid-Pilot

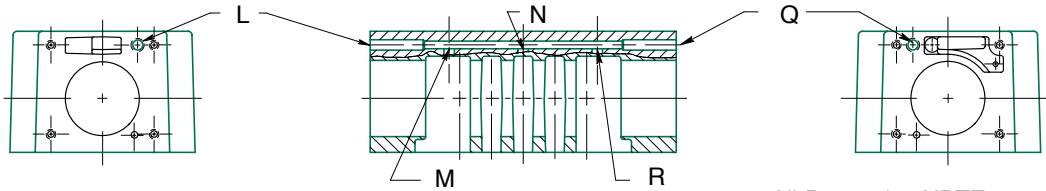

All Ports 1/16 NPTF use plug #129-118.

PILOT PORT	INTERNAL SUPPLY FROM PORT P		EXTERNAL SUPPLY FROM PORT CB*		EXTERNAL SUPPLY FROM PORT CA*		INTERNAL SUPPLY FROM PORT EB		INTERNAL SUPPLY FROM PORT EA	
	BA4	BB4	BA4	BB4	BA4	BB4	BA4	BB4	BA4	BB4
L	Plug	Open	Open	Open	Plug	Open	Plug	Open	Plug	Open
M	Plug	Plug	Plug	Plug	Plug	Plug	Open	Open	Plug	Plug
N	Open	Open	Plug	Plug	Plug	Plug	Plug	Plug	Plug	Plug
Q	Open	Open	Open	Open	Open	Open	Open	Open	Open	Open
R	Plug	Plug	Plug	Plug	Plug	Plug	Plug	Plug	Open	Open

*The standard base for internally piloted valves does not provide pilot ports. For external pilot supply and for all air piloted valves, use only bases with ports CA and CB tapped 1/8NPTF.

Base Assembly Kits

BASE DESCRIPTION	NPTF:	1	1-1/4	1-1/2
No Electrical Receptacle: w/Pilot Ports		203-626	203-627	203-628
With Electrical Receptacle: w/Pilot Ports		203-629	203-630	203-631
With Electrical Receptacle: No Pilot Ports		203-635	203-636	203-637

Service Kits and Parts

DESCRIPTION	PART NO.
Pilot Section	SPA55-KP
Single Air-Pilot: Models 146PA4, 147PA4, 148PA4	PA140-K1
Double Air-Pilot: Models 146PP4, 147PP4, 148PP4	PA140-K2
Single Solenoid-Pilot: Models 146BA4, 147BA4, 148BA4	SPA140-K1
Double Solenoid-Pilot: Models 146BB4, 147BB4, 148BB4	SPA140-K2

(Includes all internal parts except spool, sleeve and solenoid.)

Solenoid Capsule Assemblies

VOLTAGES	120/50-60	230/50-60	12 VDC	24 VDC
Part No.	237-614	237-615	226-754	226-755

NUMATICS

*World Class Supplier
of Pneumatic Components*

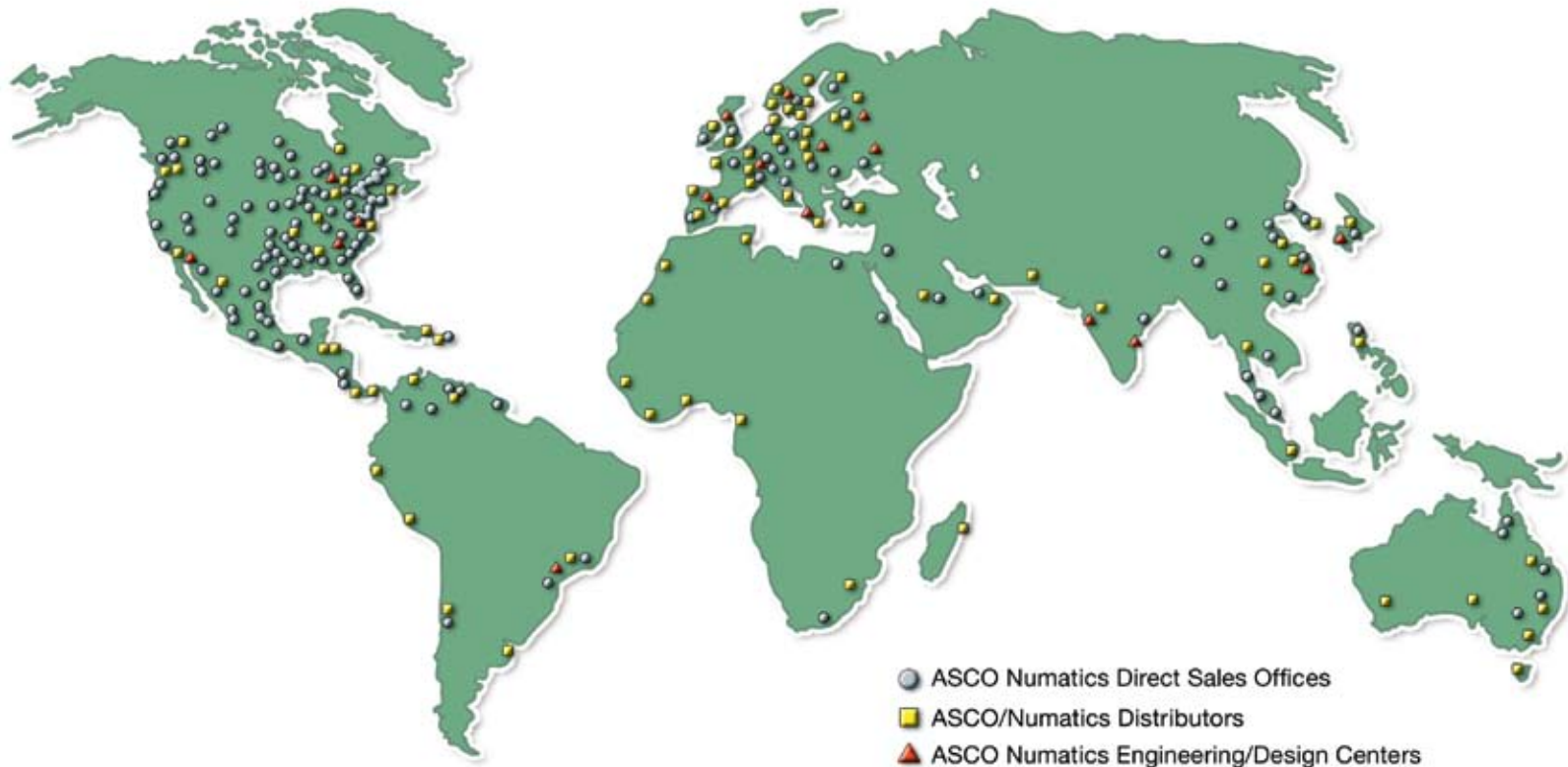

WORLD HEADQUARTERS

USA

Numatics, Incorporated

46280 Dylan Drive
Novi, Michigan 48377

P: 1-888-Numatics
1-888-686-2842

Canada

Numatics, Ltd

P: 519-452-1777

Mexico

Numatics de Mexico S.A. de C.V.

P: 52-222-284-6176

For a comprehensive listing of all Numatics production and distribution facilities worldwide, visit:

www.numatics.com