

CATALOG

slides

CGS Series
Compact Guide Slide



NUMATICS

Table of Contents



CGS Series Compact Guide Slide	3-7
Features and Benefits	3
How To Order	3
Dimensions	4
Technical Specifications	5
Switch Information	6-7



CGS Series Compact Guide Slide

A. Body

Anodized aluminum alloy, lightweight and durable. Precision machined mounting surface with tapped hole accessible from bottom side.

B. Tool Plate

Precision machined anodized aluminum alloy, easy access mounting holes for tooling attachment.

C. Bearings

Two choices, recirculating ball for heavy-duty applications and sintered bronze for medium to light duty applications.

D. Rod Wipers

Steel reinforced rod wiper assures wiping action on guide shafts to protect bearings from operating environment contamination.

E. Guide Shafts

Hardened, ground and polished, Oversized diameter for additional load support and rigidity.

F. Piston

Internal to body. Magnetic band for position sensing standard on all sizes and strokes.

G. Sensor Mounting Track

Machined directly in body, no external brackets, easy access for Hall effect and Reed switches.

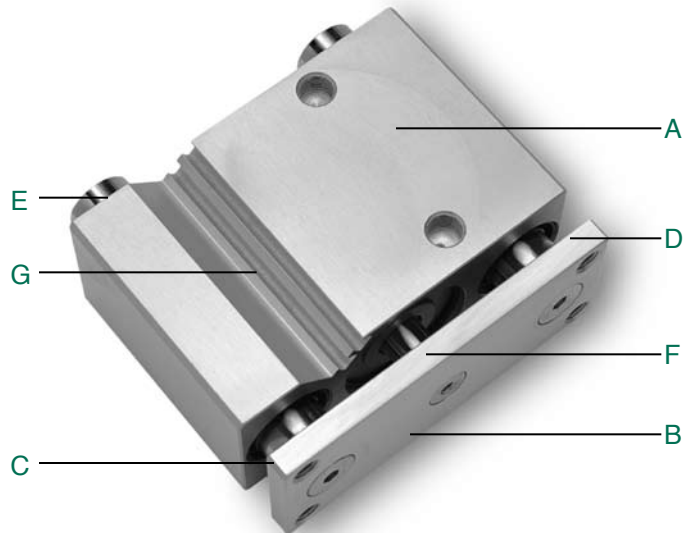

How to Order

CGS 032 050 B 1 6 D X

Bore Diameter

016 = 16 mm
020 = 20 mm
025 = 25 mm
032 = 32 mm
040 = 40 mm
050 = 50 mm

Stroke

010 = 10 mm
020 = 20 mm
025 = 25 mm
030 = 30 mm
040 = 40 mm
050 = 50 mm
075 = 75 mm
100 = 100 mm

Reference Standard Stroke table for available bore and stroke.

Bearing Option

B = Bronze Bushing
L = Linear Ball Bearing

Seal Option

1 = Polyurethane

Options

X = No Options

Sensing Position

A = Single Position Extend
B = Single Position Retract
C = Two Position Sensing
D = No Sensing

Sensing Type

Standard Cord Set
1 = Hall Effect - PNP (sourcing)
2 = Hall Effect - NPN (sinking)
3 = Reed Switch
6 = No Sensing
Quick Connect Cord Set
Z = Hall Effect - PNP (sourcing)
Y = Hall Effect - NPN (sinking)
X = Reed Switch
See Sensor section.

When Ordering Additional Sensors

SWITCH DESCRIPTION	STANDARD PART NO.	QUICK DISCONNECT PART NO.
Hall Effect - PNP (Sourcing)	HPNPS31	HPNPQ31
Hall Effect - NPN (Sinking)	HNPNS32	HNPNQ32
Reed Switch	RSS02	RSQ02
90° 5 meter cable	-	PXC90
Straight 5 meter cable	-	PXCST



CGS Series Compact Guide Slide

NUMATICS®

CGS Series Dimensions

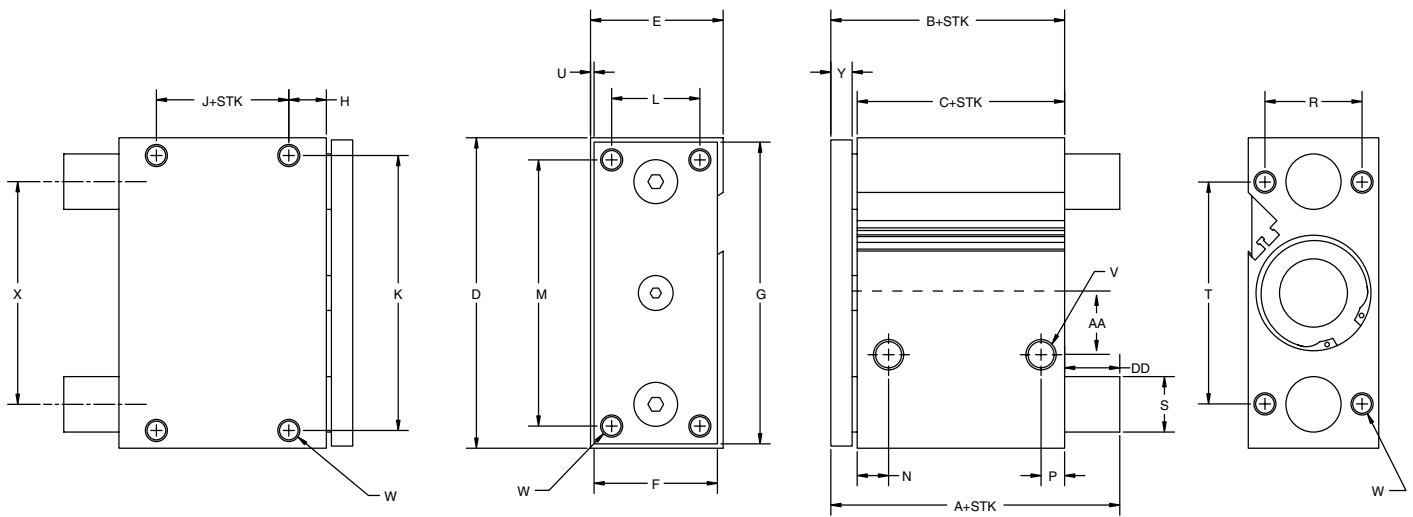

BORE	B	C	D	E	F	G	H	J	K	L	M
16	43.0	33.0	64.0	33.0	25.0	62.0	13.0	7.0	54.0	16.0	52.0
20	47.0	37.0	74.0	36.0	30.0	72.0	13.0	10.0	64.0	18.0	60.0
25	47.5	37.5	88.0	42.0	38.0	86.0	14.0	10.0	76.0	26.0	70.0
32	47.5	37.5	114.0	51.0	48.0	112.0	16.0	5.0	100.0	30.0	96.0
40	54.0	44.0	124.0	51.0	48.0	122.0	17.0	10.0	110.0	30.0	106.0
50	56.0	44.0	140.0	59.0	56.0	138.0	17.0	10.0	124.0	40.0	120.0

BORE	N	P	R	S	T	U	V	W	X	Y
16	11.0	8.0	22.0	10.0	42.0	2.5	M5	M5	38.0	9.0
20	10.5	8.5	26.0	12.0	52.0	2.0	G 1/8	M5	46.0	9.0
25	11.5	9.0	32.0	16.0	62.0	2.0	G 1/8	M6	56.0	9.0
32	12.5	9.0	38.0	20.0	80.0	2.0	G 1/8	M8	80.0	10.0
40	14.0	10.0	38.0	20.0	90.0	2.0	G 1/8	M8	90.0	10.0
50	14.0	11.0	44.0	25.0	100.0	2.0	G 1/4	M10	100.0	12.0

BORE	STROKE	
	10 TO 50 A	75 & 100 A
16	43.0	-
20	47.0	61.5
25	47.5	62.0
32	71.5	71.5
40	71.5	71.5
50	81.0	81.0

BORE	(STROKE)	
	DD	DD
16	0 (10-50)	0 (75-100)
20	0 (20-50)	19 (75-100)
25	0 (20-50)	26.5 (75-100)
32	24 (25-50)	50 (75-100)
40	17.5 (25-50)	43.5 (75-100)
50	25 (25-50)	42 (75-100)



CGS Series

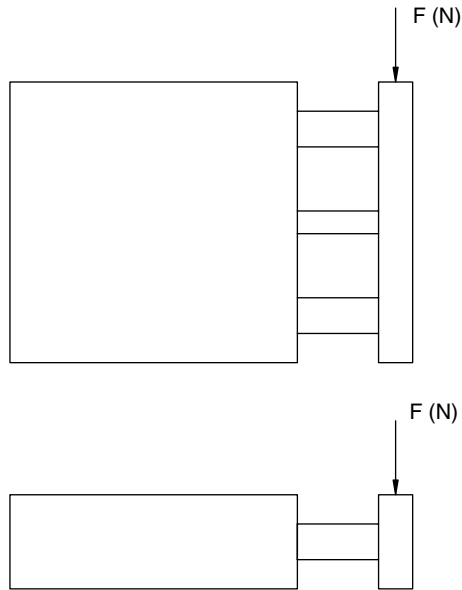

Load vs Stroke

Load Values = N (newtons)

BORE mm	BEARING TYPE	STROKE							
		10	20	25	30	40	50	75	100
16	Bronze	28.0	28.0	–	25.0	22.0	19.0	–	–
	Linear Ball	35.0	30.0	–	26.0	37.0	33.0	–	–
20	Bronze	–	51.0	–	44.0	38.0	34.0	53.0	44.0
	Linear Ball	–	55.0	–	47.0	78.0	69.0	57.0	49.0
25	Bronze	–	70.0	–	60.0	53.0	47.0	59.0	51.0
	Linear Ball	–	71.0	–	61.0	77.0	72.0	77.0	65.0
32	Bronze	–	–	88.0	–	–	59.0	137.0	108.0
	Linear Ball	–	–	196.0	–	–	167.0	275.0	216.0
40	Bronze	–	–	88.0	–	–	59.0	137.0	108.0
	Linear Ball	–	–	196.0	–	–	167.0	275.0	216.0
50	Bronze	–	–	137.0	–	–	88.0	215.0	176.0
	Linear Ball	–	–	294.0	–	–	255.0	392.0	313.0

To Convert Newtons to Pounds: newtons x 0.2248 = pounds force

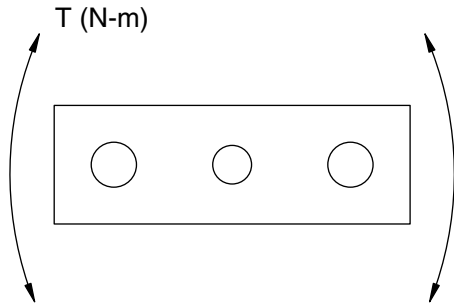

Twisting Moment vs Stroke

Moment Values = N-m (newtons)

BORE mm	BEARING TYPE	STROKE							
		10	20	25	30	40	50	75	100
16	Bronze	0.51	0.43	–	0.35	0.31	0.27	–	–
	Linear Ball	0.75	0.58	–	0.48	0.71	0.64	–	–
20	Bronze	–	0.91	–	0.78	0.71	0.63	1.04	0.88
	Linear Ball	–	1.26	–	1.06	1.77	1.58	1.22	1.01
25	Bronze	–	1.53	–	1.31	1.16	1.03	1.65	1.41
	Linear Ball	–	1.96	–	1.69	2.16	2.00	1.68	1.42
32	Bronze	–	–	1.96	–	–	2.94	2.45	1.96
	Linear Ball	–	–	3.92	–	–	0.98	2.94	2.45
40	Bronze	–	–	2.45	–	–	1.45	2.94	2.45
	Linear Ball	–	–	4.41	–	–	3.43	6.37	5.39
50	Bronze	–	–	3.43	–	–	2.45	4.90	4.41
	Linear Ball	–	–	7.35	–	–	5.88	10.78	8.33

To Convert Newtons-Meters to Inch-Pounds: newton-meters x 8.85 = inch-pounds

Output Force vs Pressure

	16	20	25	32	40	50
Extend Force (N) @ 6 bar	120 (N)	187 (N)	293 (N)	472 (N)	747 (N)	1161 (N)
Retract Force (N) @ 6 bar	91 (N)	141 (N)	247 (N)	406 (N)	624 (N)	974 (N)

Max Operating Pressure: 6 bar (87 psi)
 Operating Temperature: -20°C (-4°F) to 80°C (176°F)

To Convert Newtons to Pounds: newtons x 0.2248 = pounds



CGS Series Compact Guide Slide

NUMATICS®

CGS Series Switch Information

	SWITCH OR BRACKET DESCRIPTION	STANDARD PART NO.	QUICK DISCONNECT PART NO.
1	Hall Effect - PNP (Sourcing)	HPNPS31	HPNPQ31
1	Hall Effect -NPN (Sinking)	HNPNS32	HNPNQ32
1	Reed Switch	RSS02	RSQ02

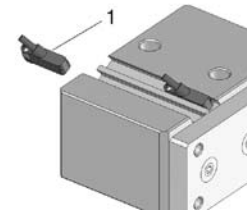

RSS02 – Reed Switch (AC/DC NO), flying lead

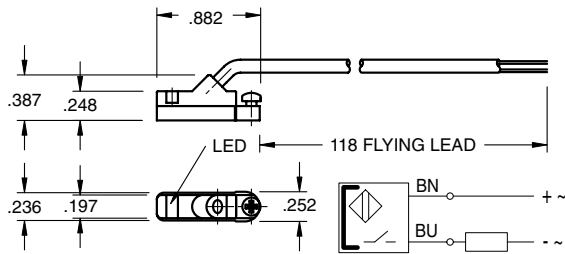

Sensing Data

Ambient temperature range T_a	(°F/°C)	-4 to 176 (-20 to 80)
Frequency of operating cycles f at U_e	(kHz)	0.5
Turn on time t	(ms)	≤ 0.25
turn off time t	(ms)	0.03
LED function indication		yes

Electrical Data

Rated operational voltage U_e	(V)	3...130 AC/DC
Supply voltage U_B	(V)	3...130 AC/DC
Voltage drop U_d at I_e Stat./dyn.	(V)	3.5
Rated insulation volatage U_i	(V)	2750 DC (EN 60335-1)
Rated supply frequency	(Hz)	AC/DC
Rated operational current I_e	(mA)	50 (10W max.)
No-load supply current I_o at U_e d./und.	(mA)	0
Observe polarity for correct LED function		

RSQ02 – 8mm connector

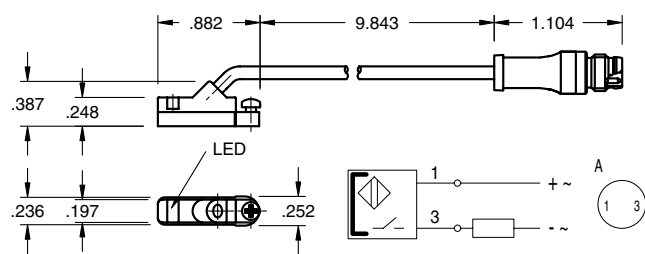

Mechanical Data

Housing material	Polyamide
Material of sensing face	Polyamide
Connection	PVC cable
Degree of Protection	IP 67
Rated shock: half-sinus, 50g, 11 ms	
Rated vibration environment: 10g, 10...2000 Hz. 90 min	



HPNPS31 – Electronic Switch (PNP NO), flying lead

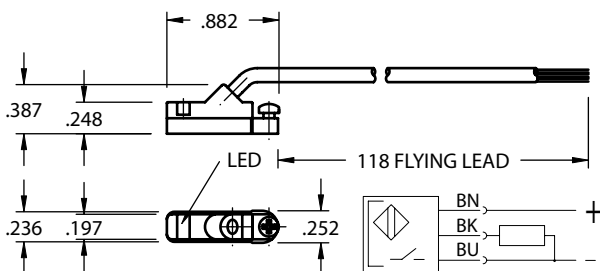

Sensing Data

Ambient temperature range d	(°F/°C)	-13 to +158 (-25 to +70)
Temperature drift	(% of)	$\leq 0.3\%/^{\circ}\text{C}$
Frequency of operating cycles f at U_e	(kHz)	10
Turn on time t	(ms)	.05
turn off time t	(ms)	.05
Utilization categories		DC13
Function-/supply voltage indication		YES

Electrical Data

Rated operational voltage U_e	(V)	24 DC
Supply voltage U_B	(V)	10...30 DC
incl. ripple	(% of U_e)	15
Voltage drop U_d at I_e Stat./dyn.	(V)	1/-
Rated insulation volatage U_i	(V)	75 AC
Rated supply frequency	(Hz)	DC
Rated operational current I_e	(mA)	200
No-load supply current I_o at U_e d./und.	(mA)	25/13
Protected against polarity reversal		YES

HPNPQ31 – 8mm connector

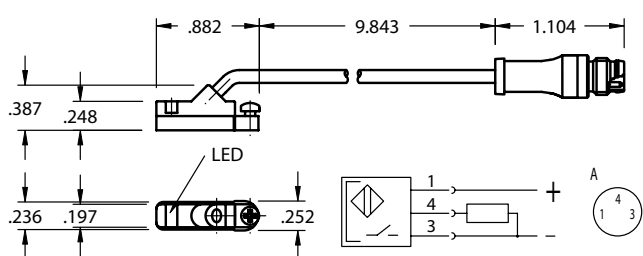

Mechanical Data

Housing material	Polyamide
Material of sensing face	Polyamide
Connection	PVC cable
Degree of Protection	IP 67
Rated shock: half-sinus, 30 g, 11 ms	
Rated vibration environment: 55 Hz, 1mm amplitude, 3 x 30	





HNPNS32 – Electronic Switch (NPN NO), flying lead

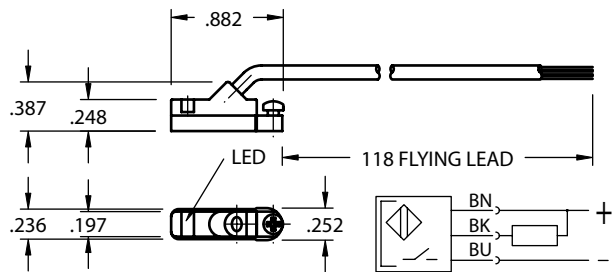

Sensing Data

Ambient temperature range t_d	(°F/°C)	-13 to +158 (-25 to +70)
Temperature drift	(% of S_T)	$\leq 0.3\%/^{\circ}\text{C}$
Frequency of operating cycles f at U_e	(kHz)	10
Turn on time t	(ms)	.05
turn off time t	(ms)	.05
Utilization categories		DC13
Function–supply voltage indication		YES

Electrical Data

Rated operational voltage U_e	(V)	24 DC
Supply voltage U_B	(V)	10...30 DC
incl. ripple	(% of U_e)	15
Voltage drop U_d at I_e Stat./dyn.	(V)	1/-
Rated insulation volatage U_i	(V)	75 AC
Rated supply frequency	(Hz)	DC
Rated operational current I_e	(mA)	200
No-load supply current I_o at U_e d./und.	(mA)	25/13
Protected against polarity reversal		YES

HNPNQ32 – 8mm connector

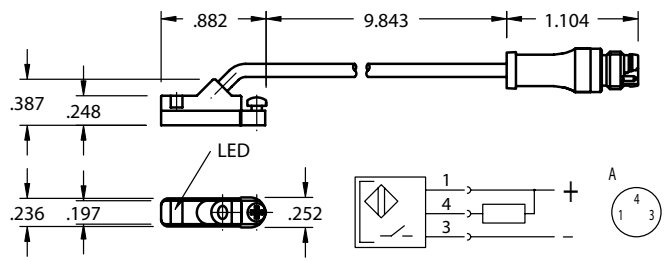

Mechanical Data

Housing material	Polyamide
Material of sensing face	Polyamide
Connection	PVC cable
Degree of Protection	IP 67
Rated shock: half-sinus, 30 g, 11 ms	
Rated vibration environment: 55 Hz, 1mm amplitude, 3 x 30	



Female Connectors for Reed Switches and Hall Effect Sensors

Dimensions (mm)

TYPE	ORDER CODE
Straight, 5 m Cable	PXCST
Elbow, 5 m Calbe	PXC90

Straight Type

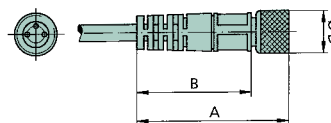

Elbow Type

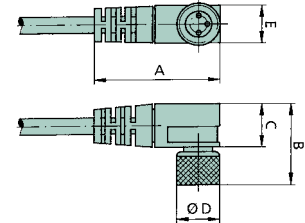

NUMATICS

*World Class Supplier
of Pneumatic Components*

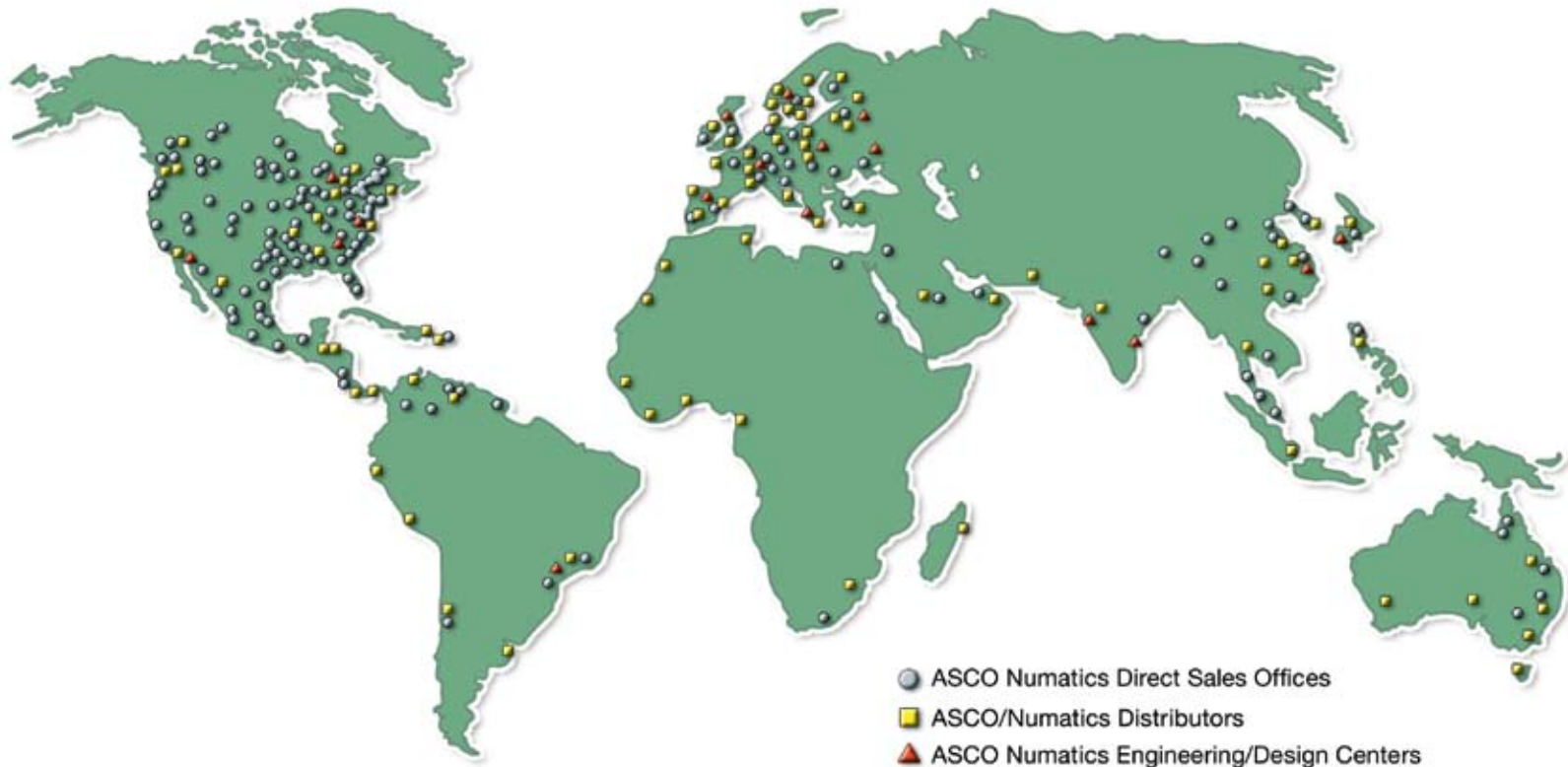

WORLD HEADQUARTERS

USA

Numatics, Incorporated

46280 Dylan Drive
Novi, Michigan 48377

P: 1-888-Numatics
1-888-686-2842

Canada

Numatics, Ltd

P: 519-452-1777

Mexico

Numatics de Mexico S.A. de C.V.

P: 52-222-284-6176

For a comprehensive listing of all Numatics production and distribution facilities worldwide, visit:

www.numatics.com