

Plarail chain Series

Features

- Plarail chains are cable, hose protection, and guiding devices all made of plastic. They protect and guide cables and hoses without twists or turns in motion of industrial robots, machine tools, and conveying machines.
 - Strength, light weight, and smooth motion is realized by connecting to chains made of engineering plastic. Adjustment of length is easy.
- HPU, HPO series
- Flaps can be opened or closed either from right or left which is convenient for replacement of cables.
 - Smooth in motion, quiet in noise, excellent in safety and durability, handling is easy.
 - Following all the linear and complex motion of mobile parts of machines and tools, they protect and guide cable and hoses.
- HPO series
- They protect cables and hoses from dust particles.
- HPE series(R50~R200mm·R15.2~61.0in.)
- Cables can be separated according to their types. The right and left of the separated compartment has its own flap and, thus, only the necessary flap can be opened or closed. Bending radius can be selected from 5 types according to devices and cables.
- HPK series
- Single cable or hose can be protected or guided. This type is optimal for mass-produced low-cost and compact special purpose tools.
- HPM series
- This type is low-cost full-cover type and protect cables and hoses from dusts and foreign particles.
- HPC series
- This low-noise type does not require tools for replacement of cables. Low-noise is realized by the construction by small blocks and adoption of special engineering plastic.

Mounting Example

(a)Horizontal slide mounting 1
(Upper plane slide)

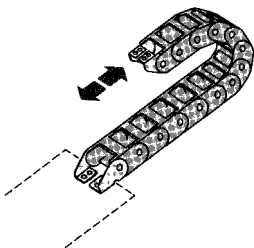

(b)Horizontal slide mounting 2
(Lower plane slide)

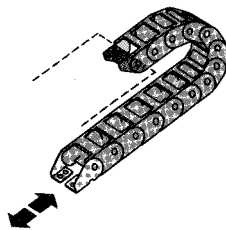

(c)Vertical slide mounting 1
(Reversed U shape)

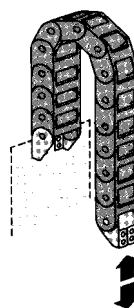

(d)Vertical slide mounting 2
(U shape)

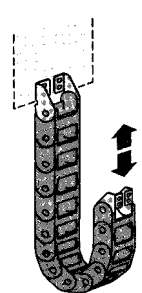

(e)Side slide mounting

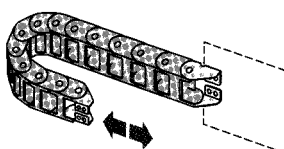

(f)Counter slide mounting

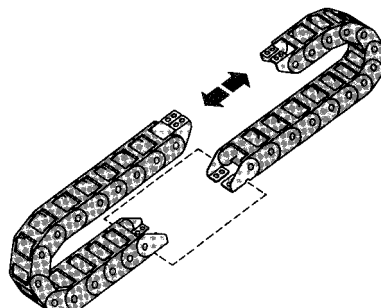

(g)Complex slide mounting

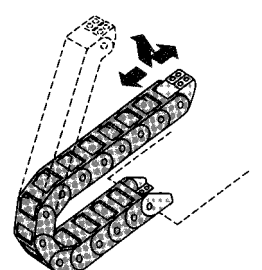

Specifications

		Flap open & close type							
Series	HPU series								
Type	HPU 102	HPU 202	HPU 203	HPU 204	HPU 206	HPU 306	HPU 408	HPU 412	HPU 615
Minimum bending radius R (mm)	19	25 30 45	30 45	38 50	50 100 150	50 100 150 200	50 75 100 150 200	75 100 150 200	
Size (mm) (Maximum cable dia · hose O.D.)									
Pitch (mm)	20	25		32			45		70
No. of links (/m)	50	40		32			23		15
*Maximum free span (m)	0.25	0.75		1			1.5		3
Maximum stroke (m)	0.4	1.4		1.9			2.9		5.8
Maximum cable and hose weight (N/m)	14.7	5.9		9.8		39.2	49.0		245.2
Maximum speed (m/s)	2.5								
Plarail chain weight (N/m)	1.18	2.45	2.55	4.90	5.49	6.28	10.8	12.7	24.1
Service temperature range (°C)	-10~80								
Service conditions	Avoid acidic or basic atmosphere or hot water.								
Opening and closing operation	<p>Open and close either from right or left.</p>								
Diaphragm ordering code	—			—			SB-4		SB-6
ordering code of Flap alone	HPU 102 Flap	HPU 202 Flap	HPU 203 Flap	HPU 204 Flap	HPU 206 Flap	HPU 306 Flap	HPU 408 Flap	HPU 412 Flap	HPU 615 Flap

Specifications

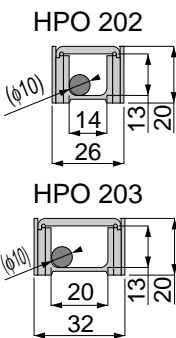
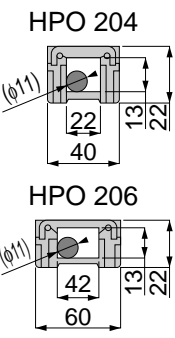
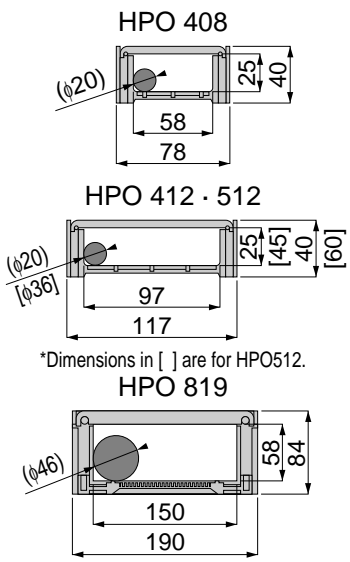
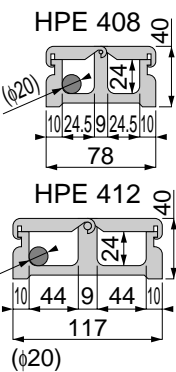
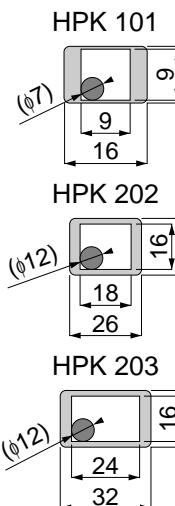
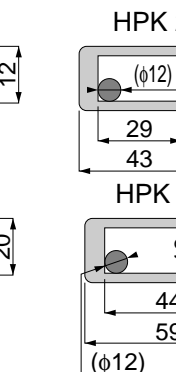
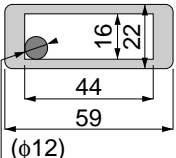
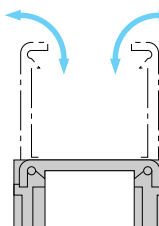
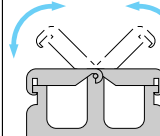
Open & close full cover type								Separated open & close type		No flap type					
HPO series								HPE series		HPK series					
HPO 202	HPO 203	HPO 204	HPO 206	HPO 408	HPO 412	HPO 512	HPO 819	HPE 408	HPE 412	HPK 101	HPK 202	HPK 203	HPK 204	HPK 206	
30 45		38 50		70 100 150 200		100 150 200 300 400		50 75 100 150 200		19	30 45		38 50		
				 <p style="font-size: small;">*Dimensions in [] are for HPO512. HPO 819</p>											
20		26		45		60		45		20	25		32		
50		39		23		17		11		23	40		32		
0.75		1		1.5		4.5		2.5		0.37	0.75		1		
1.4		1.9		2.9		8.8		4.6		0.64	1.4		1.6		
2.9		12.2		49.0		300.0		343.2		24.5	1.6		44.1		
2.5								2.5		1		2.5			
2.74	3.04	4.90	5.88	13.3	16.7	21.1	43.1	10.8	12.7	1.03	2.18	2.35	4.41	5.00	
-10~80															
Avoid acidic or basic atmosphere or hot water.															
<p>Open and close either from right or left.</p> 								<p>Open and close independently in right or left of the separator.</p> 		<p>HPK comes without flaps.</p>					
—				SB-4		—		SB-8		—					
HPO 202	HPO 203	HPO 204	HPO 206	HPO 408	HPO 412	HPO 512	HPO 819	HPE 408	HPE 412	—					
Flap	Flap	Flap	Flap	Flap	Flap	Flap	Flap	Flap	Flap	—					

Specifications

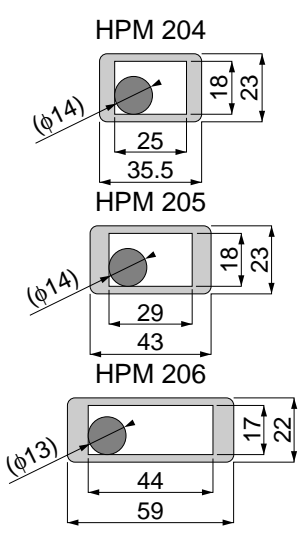
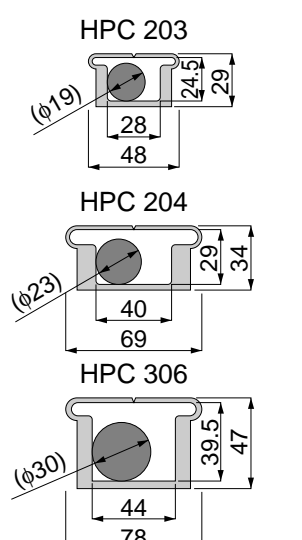
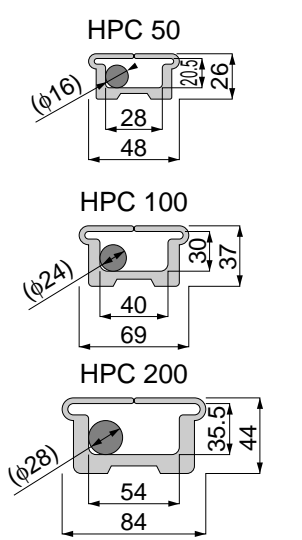
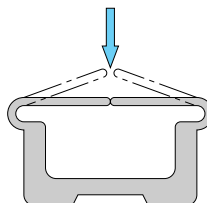
	Full cover type			Low noise type					
Series	HPM Series			HPC Series					
Type	HPM 204	HPM 205	HPM 206	HPC 203	HPC 204	HPC 306	HPC 50	HPC 100	HPC 200
Minimum bending radius R (mm)	28		38 50	30 45 60	50 90 150	50 100 150	60	90	105
Size (mm) (Maximum cable dia · hose O.D.)									
Pitch (mm)	15		22	25	32	45	25		
No. of links (/m)	67		46	40	32	23	40		
*Maximum free span (m)	1			0.75	1				
Maximum stroke (m)	0.9		1.2	1.4	1.7	1.8	1.9		
Maximum cable and hose weight (N/m)	24.5		34.3	24.5	39.2	68.6	9.8	4.9	
Maximum speed (m/s)	2.5								
Plarail chain weight (N/m)	3.33	3.82	4.51	3.63	5.78	7.65	3.51	5.96	10.4
Service temperature range (°C)	-10~80			0~50		-10~80		0~50	
Service conditions	Avoid acidic or basic atmosphere or hot water.								
Opening and closing operation	HPM comes without flaps.			Cut the pointed place by knife or nipper. Flap can be opened or closed by finger tips. <div style="text-align: center; margin-top: 10px;">  </div>					
Diaphragm ordering code	—			—	—	—	—	—	—
ordering code of Flap alone	—			—	—	—	—	—	—

Capacity chart

Select the optimal parail chain from capacity chart provided below once total weight of cable and hose, the maximum O.D. , and stroke are determined. Please make sure that the bending radius of parail chain is larger than bending radius of cable and hose.

note 1) F=Free span

Horizontal motion length

note 2) Dimensions marked with * include safety length

note 3) The chart was plotted while the fixed end locates in the center of stroke

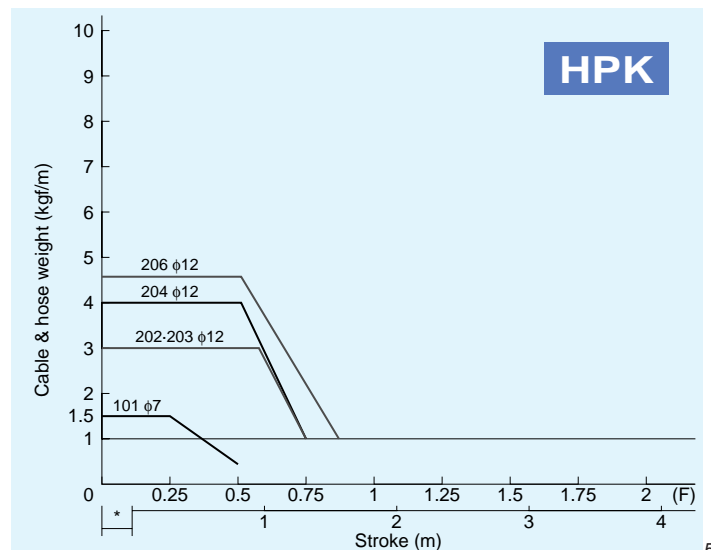
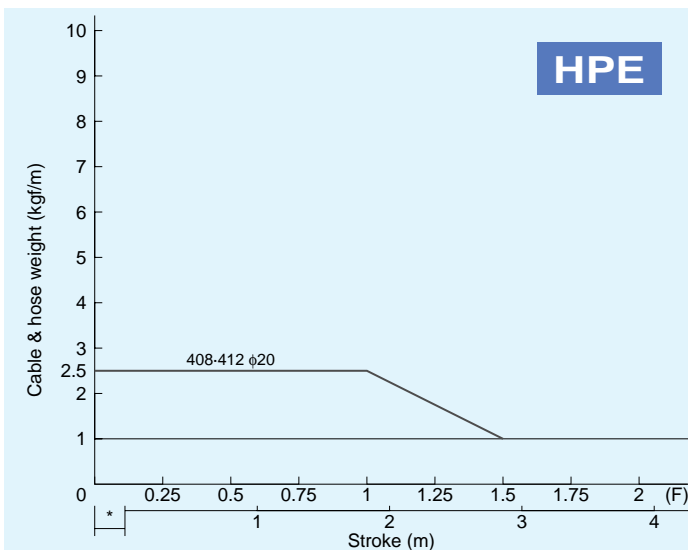
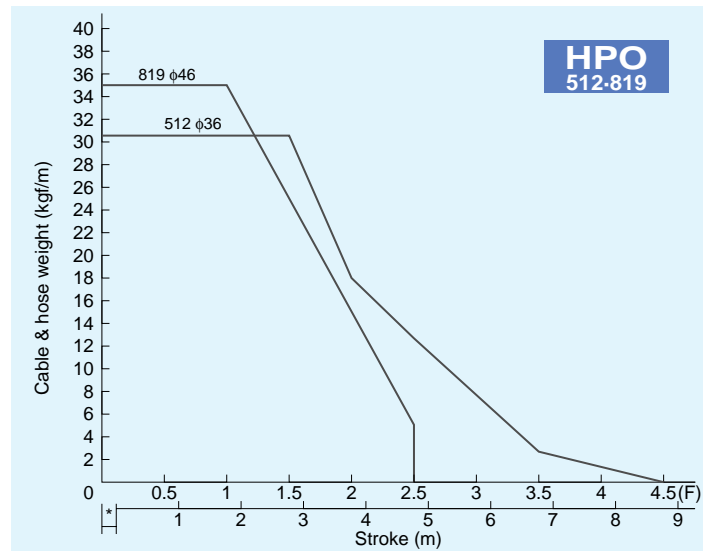
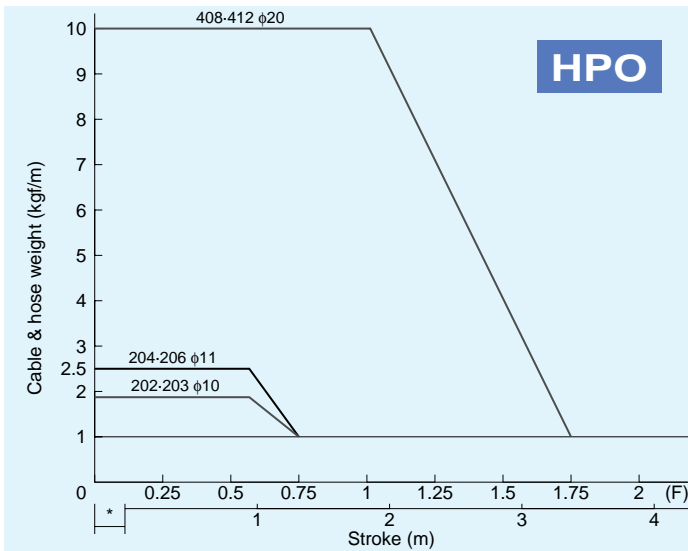
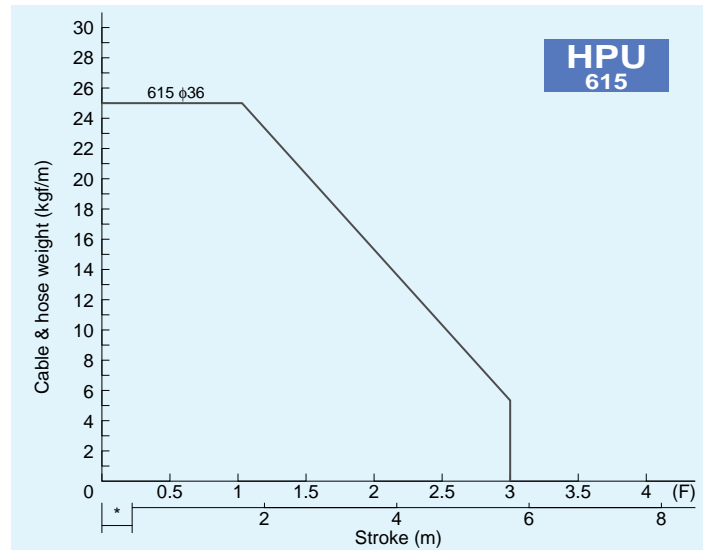
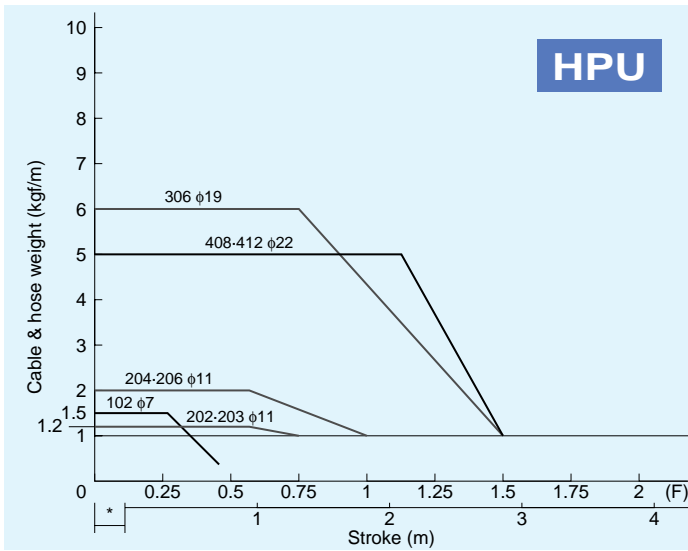

Capacity chart

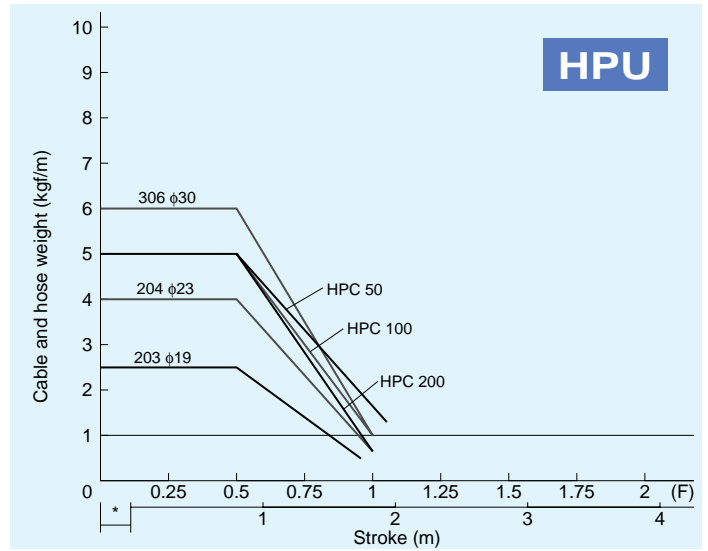
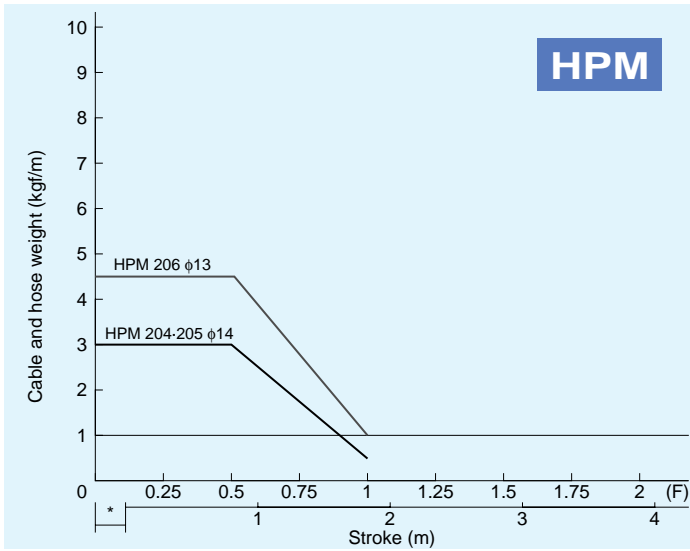

Calculation of Number of Links

Number of links is to be calculated by the following equation:

$$n = \frac{\frac{S}{2} + \pi R + 2K}{P}$$

n : No. of links (Figures below decimal point raised to one positive number)

S : Transfer stroke (mm)

R : Bending radius (mm)

K : Play (mm)

P : Pitch (mm)

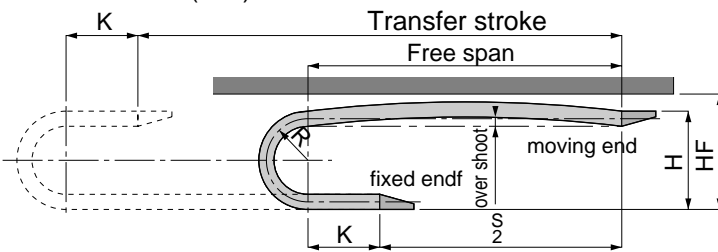

*HF in the chart above is the height which Parailchains are able to pass through using under the length of free span with allowable expansion without load such as cables, hoses, etc.

unit:mm

Series	R	H	HF	K	πR	$\pi R + 2K$
HPU 102	19	50	65	20 or more	59.7	99.7 or more
HPU 202, 203	25	70	85	25 or more	78.5	128.5 or more
HPO 202, 203	30	80	95		94.2	144.2 or more
HPK 202, 203	45	110	125		141.3	191.3 or more
HPU 204, 206	38	98	118	30 or more	119.3	179.3 or more
HPO 204, 206	50	122	142		157.0	217.0 or more
HPK 204, 206						
HPU 306	50	134	160	50 or more	157.0	257.0 or more
	100	234	260		314.0	414.0 or more
	150	334	360		471.0	571.0 or more
HPU 408, 412 (HPO 408, 412)	50	140	170	50 or more	157.0	257.0 or more
	75	190	220		235.0	335.5 or more
	100	240	270		314.0	414.0 or more
	150	340	370		471.0	571.0 or more
	200	440	470		628.0	728.0 or more
	(70)	(180)	(210)		(219.8)	(319.8 or more)
HPU 615	75	214	275	70 or more	235.5	375.5 or more
	100	246	325		314.0	454.0 or more
	150	364	425		471.0	611.0 or more
	200	464	525		628.0	768.0 or more
HPE 408, 412	50	140	180	50 or more	157.0	257.0 or more
	75	190	230		235.0	385.0 or more
	100	240	280		314.0	414.0 or more
	150	340	380		471.0	571.0 or more
	200	440	480		628.0	728.0 or more
HPO 512	100	260	320	60 or more	314.0	434.0 or more
HPO 819	150	384	445	90 or more	471.0	651.0 or more
	200	484	545		628.0	808.0 or more
	250	584	645		785.0	965.0 or more
	300	684	745		942.0	1,122.0 or more
	400	884	945		1,256.0	1,436.0 or more
HPK 101	19	50	62	25 or more	59.7	109.7 or more
HPM 204, 205	28	79	100	15 or more	87.9	117.9 or more
HPM 206	38	98	118	25 or more	119.3	169.3 or more
	50	122	142		157.0	207.0 or more
HPC 203	30	98	120	25 or more	94.2	144.2 or more
	45	128	150		141.3	191.3 or more
	60	158	180		188.4	238.4 or more
HPC 204	50	146	165	30 or more	157.0	271.0 or more
	90	226	245		282.6	342.6 or more
	150	346	365		471.0	531.0 or more
HPC 306	50	160	177	50 or more	157.0	257.0 or more
	100	260	277		314.0	414.0 or more
	150	360	377		471.0	571.0 or more
HPC 50, 100, 200	60	152	206	90 or more	188.4	368.4 or more
	90	227	257		282.6	462.6 or more
	105	260	295		329.7	509.7 or more

Notice

- The total volume of contents (tubes, cables, and etc.) in Parailchains should be arranged not to exceed 60% of the Inside capacity of each model.
- Contents should be lined up without crossing each other when they are stored into Parailchains.
- Contents should be stored well-balanced in right and left in Parailchains.
- Please avoid applying excessive forces to Metal Brackets by Keeping proper Bendings, max. Free Span, Max. Transfer Stroke, max. Cable/Hose Weight, and max. Transfer Speed. and etc.
- In case of different contents such as air tubes, water tubes, cables, and/or etc. are stored into the same body, please select Bending Radius of Parailchains according to the largest Bending Radius among the contents.

HPU Model Dsignation (Example)

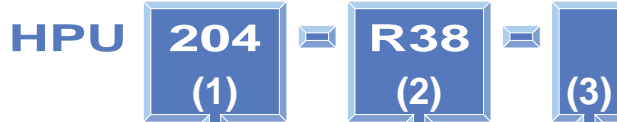

(1)Size (Bulk Dimensions-Height×Width)

Code	102	202	203	204	206
size(mm)	12×27	20×26	20×32	22×40	22×60
size(inch)	0.47×1.06	0.79×1.02	0.79×1.26	0.87×1.57	0.87×2.36
Code	306	408	412	615	
size(mm)	34×60	40×78	40×117	64×146	
size(inch)	1.34×2.36	1.57×3.07	1.57×4.61	2.52×5.75	

(2)Bending radius

	R19	R25	R30	R38	R45	R50	R75	R100	R150	R200
102	○									
202		○	○		○					
203			○		○					
204,206				○		○				
306						○		○	○	
408,412						○	○	○	○	○
615							○	○	○	○

(3)Color

No color : Black

W : Ivory (102, 202, 203, 204, 206 only)

*Two kinds of brackets, one for fixed end and the other for movable end, are required.

Select a designation code for the bracket from page 614.

HPO Model Dsignation (Example)

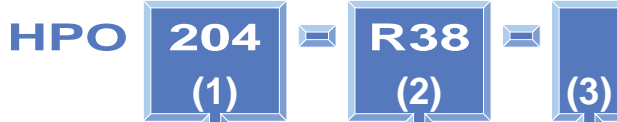

(1)Size (Bulk Dimensions-Height×Width)

Code	202	203	204	206
size(mm)	20×26	20×32	22×40	22×60
size(inch)	0.79×1.02	0.79×1.26	0.87×1.57	0.87×2.36
Code	408	412	512	819
size(mm)	40×78	40×117	60×117	84×190
size(inch)	1.57×3.07	1.57×4.61	2.36×4.61	3.31×7.45

(2)Bending radius

	R30	R38	R45	R50	R70	R100	R150	R200	R250	R300	R400
202, 203	○		○								
204, 206		○		○							
408, 412					○	○	○	○			
512						○					
819							○	○	○	○	○

(3)Color

No color : Black

W : Ivory (202, 203, 204, 206 only)

*Two kinds of brackets, one for fixed end and the other for movable end, are required.

Select a designation code for the bracket from page 614.

HPE Model Dsignation (Example)

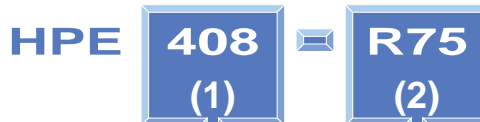

(1)Size (Bulk Dimensions-Height×Width)

Code	408	412
size(mm)	40×78	40×117
size(inch)	1.57×3.07	1.57×4.61

(2)Bending radius

	R50	R75	R100	R150	R200
408	○	○	○	○	○
412	○	○	○	○	○

*Color is black only

*Two kinds of brackets, one for fixed end and the other for movable end, are required.

Select a designation code for the bracket from page 614.

HPK Model Dsignation (Example)

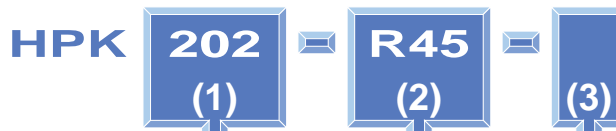

(1)Size (Bulk Dimensions-Height×Width)

Code	101	202	203	204	206
size(mm)	12×16	20×26	20×32	22×43	22×59
size(inch)	0.47×0.63	0.79×1.02	0.79×1.26	0.87×1.69	0.87×2.32

(2)Bending radius

	R19	R30	R38	R45	R50
101	○				
202,203		○		○	
204,206			○		○

(3)Color

No color : Black
W : Ivory

*Two kinds of brackets, one for fixed end and the other for movable end, are required. Select a designation code for the bracket from page 614.

HPM Model Dsignation (Example)

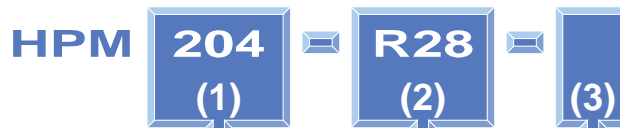

(1)Size (Bulk Dimensions-Height×Width)

Code	204	205	206
size(mm)	23×35.5	23×43	22×59
size(inch)	0.91×1.40	0.91×1.69	0.87×2.32

(2)Bending radius

	R28	R38	R50
204,205	○		
206		○	○

(3)Color

No color : Black
W : Ivory

*Two kinds of brackets, one for fixed end and the other for movable end, are required. Select a designation code for the bracket from page 614.

HPC (New size) Model Dsignation (Example)

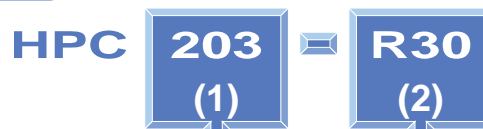

(1)Size (Bulk Dimensions-Height×Width)

Code	203	204	306
size(mm)	29×48	34×69	47×78
size(inch)	1.14×1.89	1.34×2.72	1.85×3.07

(2)Bending radius

	R30	R45	R50	R60	R90	R100	R150
203	○	○		○			
204			○		○		○
306			○			○	○

*Two kinds of brackets, one for fixed end and the other for movable end, are required. Select a designation code for the bracket from page 614.

HPC Model Designation(Example)

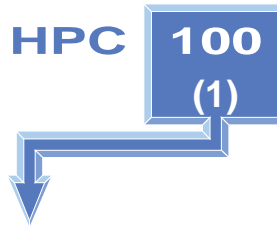

(1)Size(Bulk Dimensions-Height×Width)

Code	50	100	200
Size(mm)	26×48	37×69	43×84
Size(inch)	1.02×1.89	1.46×2.72	1.73×3.31
Bending radius(mm)	60	90	105
Bending radius(inch)	2.36	3.54	4.13

⚠ Detailed Safety Instructions

Before using the PISCO device, be sure to read the "Safety Instructions", "Common Safety Instructions for Products Listed in This Manual" on pages 23~24.

⚠ Warning

1. Never step on Plarailchain. Otherwise the chain may break and you will fall down.
2. When connecting, disconnecting, opening, closing, or carrying out maintenance and checks, hold the Plarailchain motionless. Otherwise the Plarailchain may run or fall under its own weight, thus doing injuries to you.
3. Pay attention to the flexing areas of the Plarailchain. You can get injured with your hand caught in the flexing area.
4. Before conducting maintenance or checks of Plarailchain, be sure to turn off power supply to the equipment for your safety.
5. The Plarailchains should only be used within stated specifications and conditions.
6. Never perform disassembly or remodeling that can affect the basic structure, performance or function of the equipment.
7. In applications where operation is frequently done or subject to vibration, tighten up all the breakets. Loseness of them can cause a breakdown of the whole system.

⚠ Caution

1. Carefully read the "Safety Instructions" section in this catalogue before use.
2. Examine the Plarailchains Performance Curve Chart in manual to select suitable type. Remember to test the Plarailchains before use since other factors may affect performance.
3. Cables and hoses to be stored must be flexible and wear-resistant, do not use wire-braided ones which are prone to damage.
4. For use under special circumstances, contact PISCO for guidance.

Plarailchains Series HP Series

HPU
102

Flap open & close type

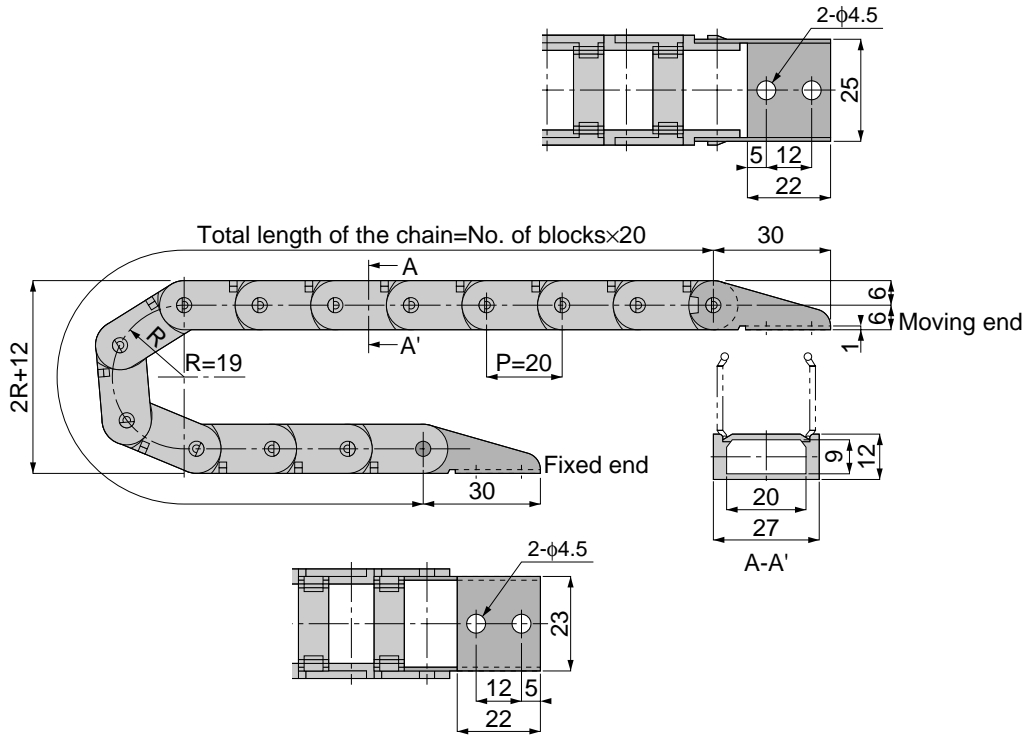

HPU
202 - 203

Flap open & close type



HPU 202-R

HPU 203-R

R: Minimum bending radius

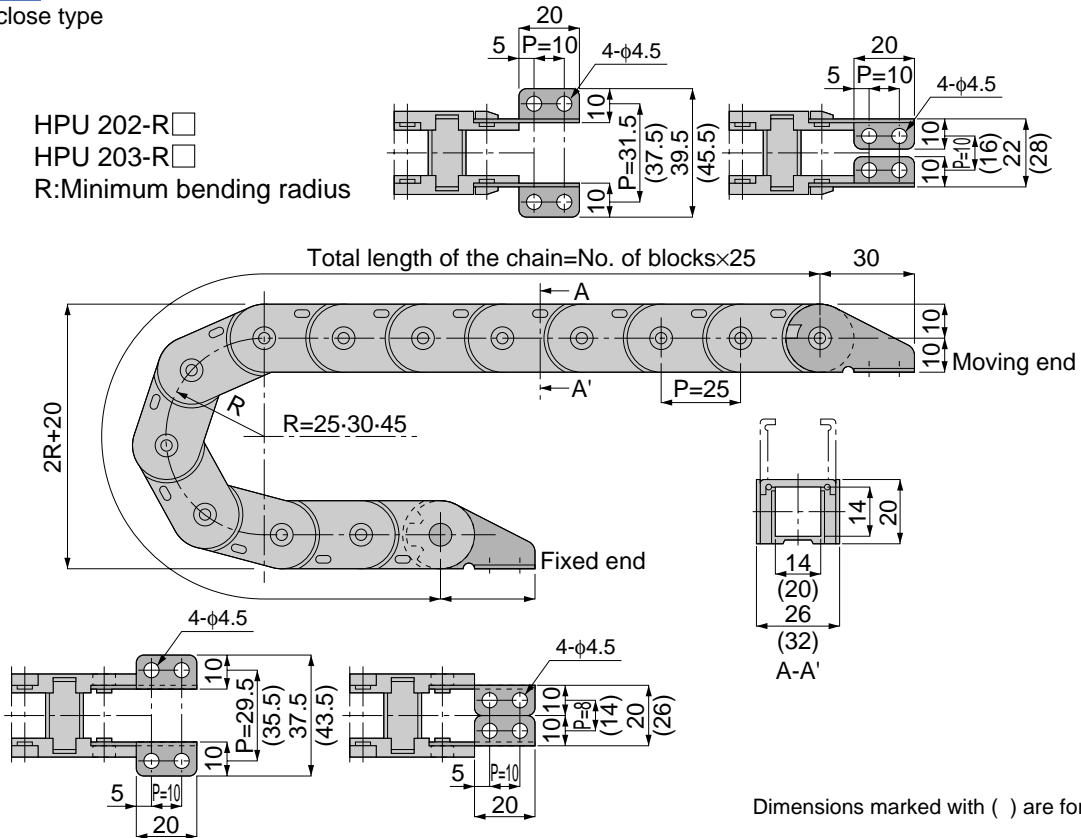

HPU 204 · 206

Flap open & close type



HPU 204-R □
HPU 206-R □
R: Minimum bending radius

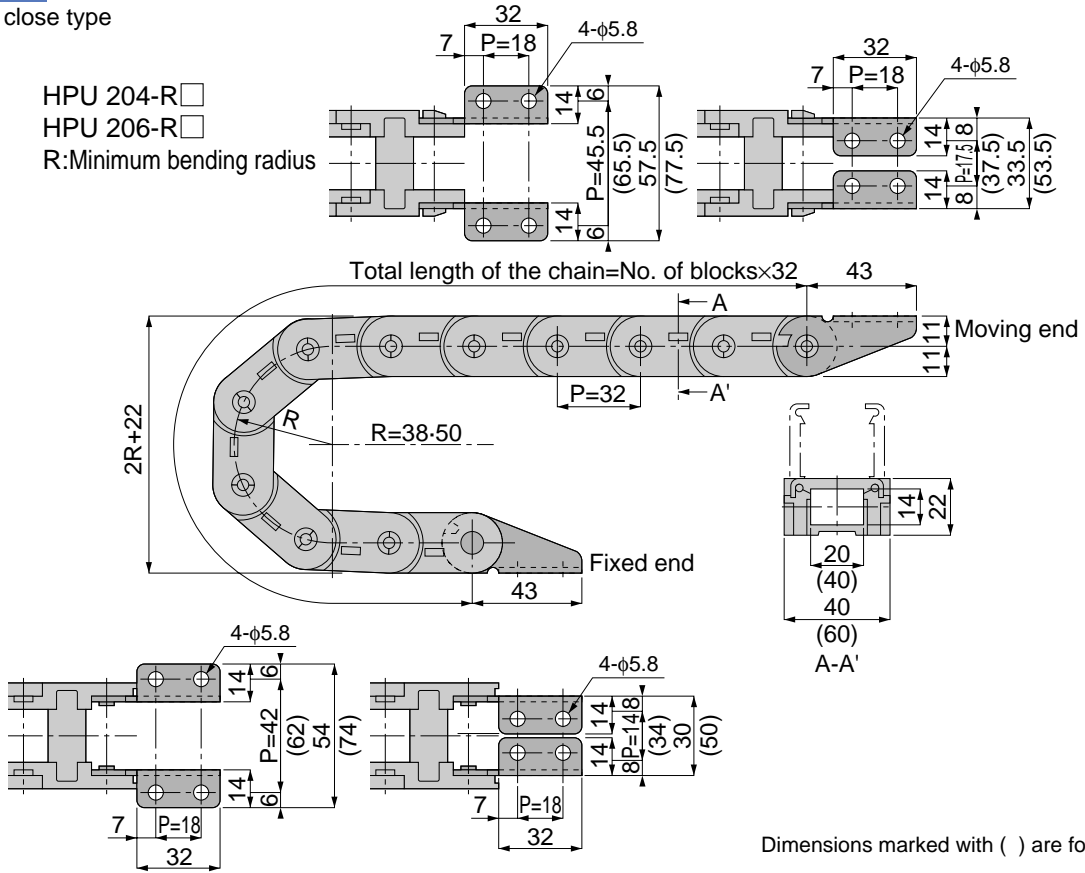

HPU 306

Flap open & close type



HPU 306-R □
R: Minimum bending radius

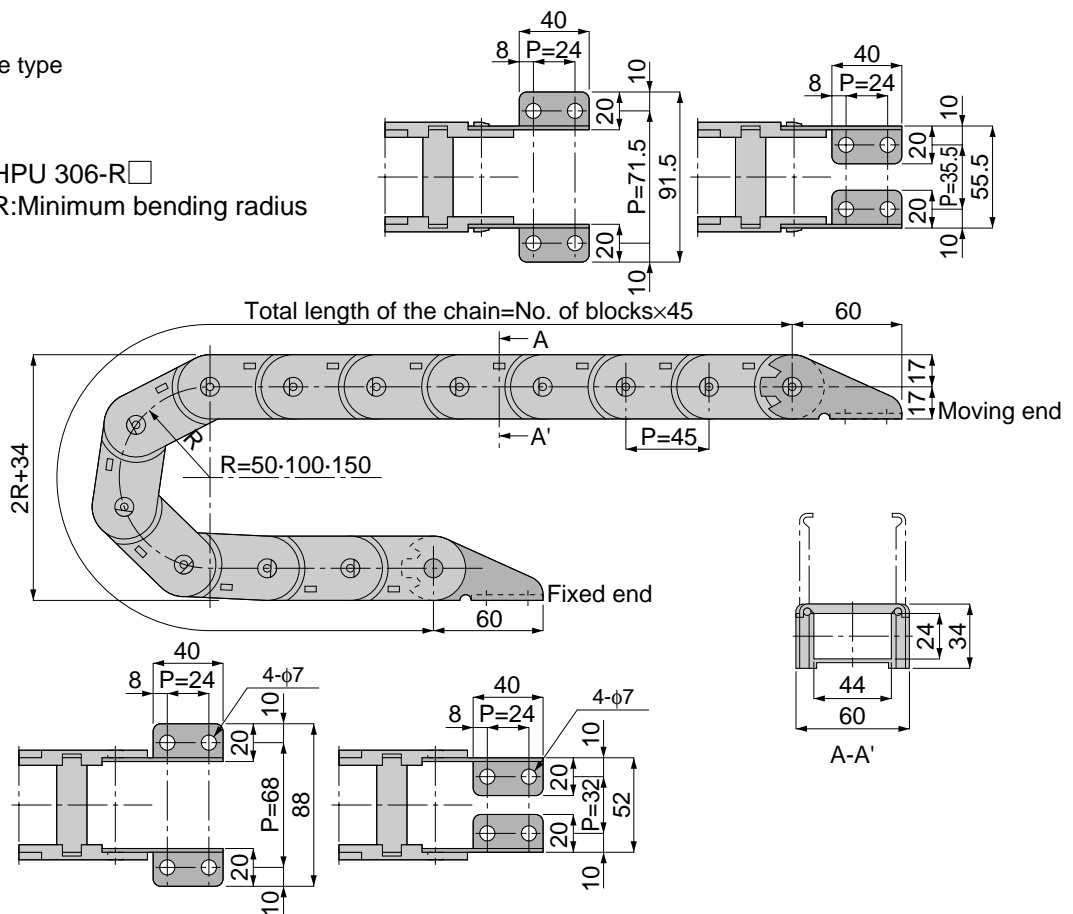

Plarailchains Series HP Series

HPO 408 · 412

Flap open & close Full cover type



HPO 408-R□

HPO 412-R□

R: Minimum bending radius

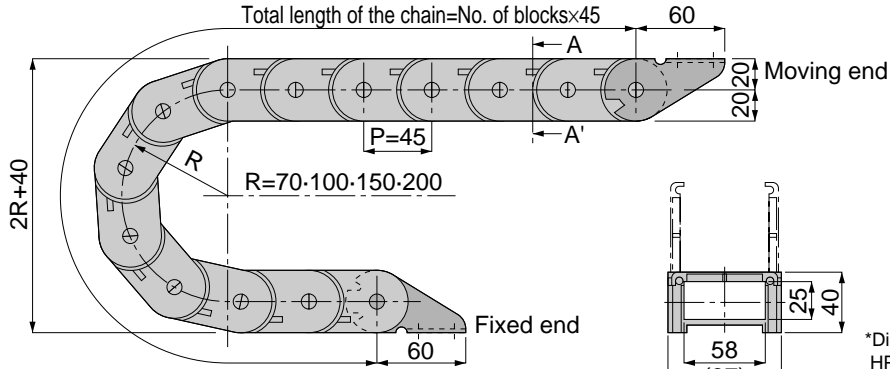
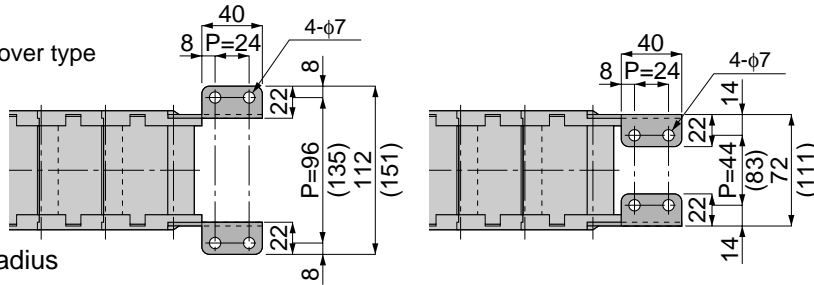

*Diaphragm can be installed is HPO 408 and 412. (Refer to page 603.)

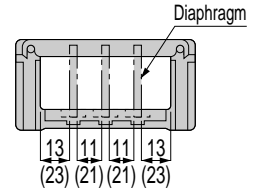

Diaphragm: SB-4

Dimensions marked with () are for HPO 412-R□

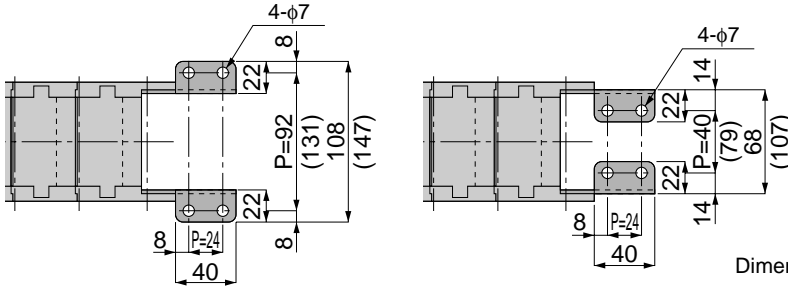

HPO 512

Flap open & close Full cover type

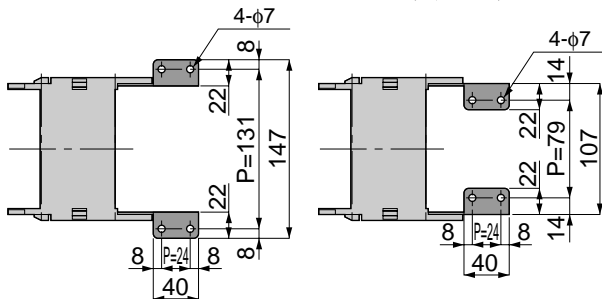
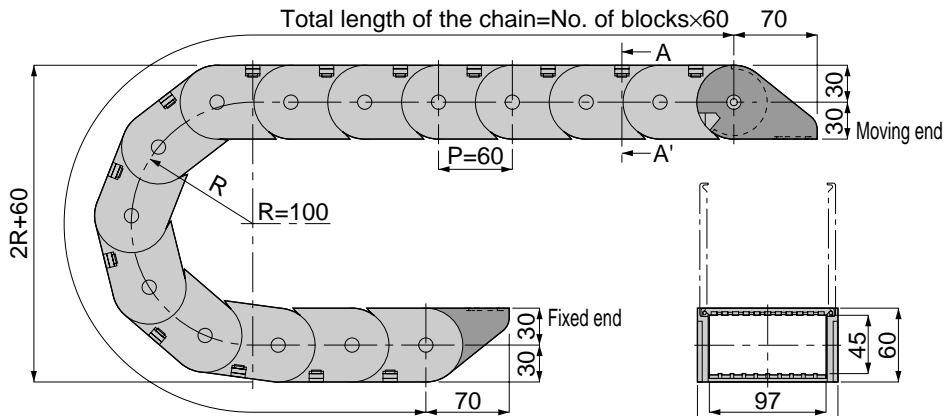
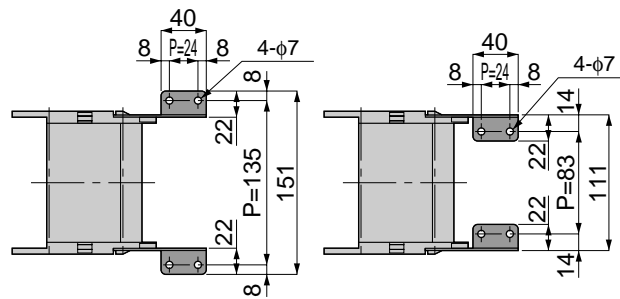

HPO 819

Flap open & close full cover type



HPO 819-R□

R:Minimum bending radius

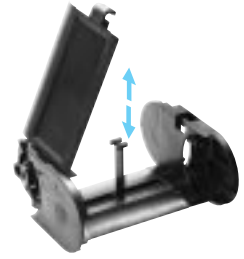
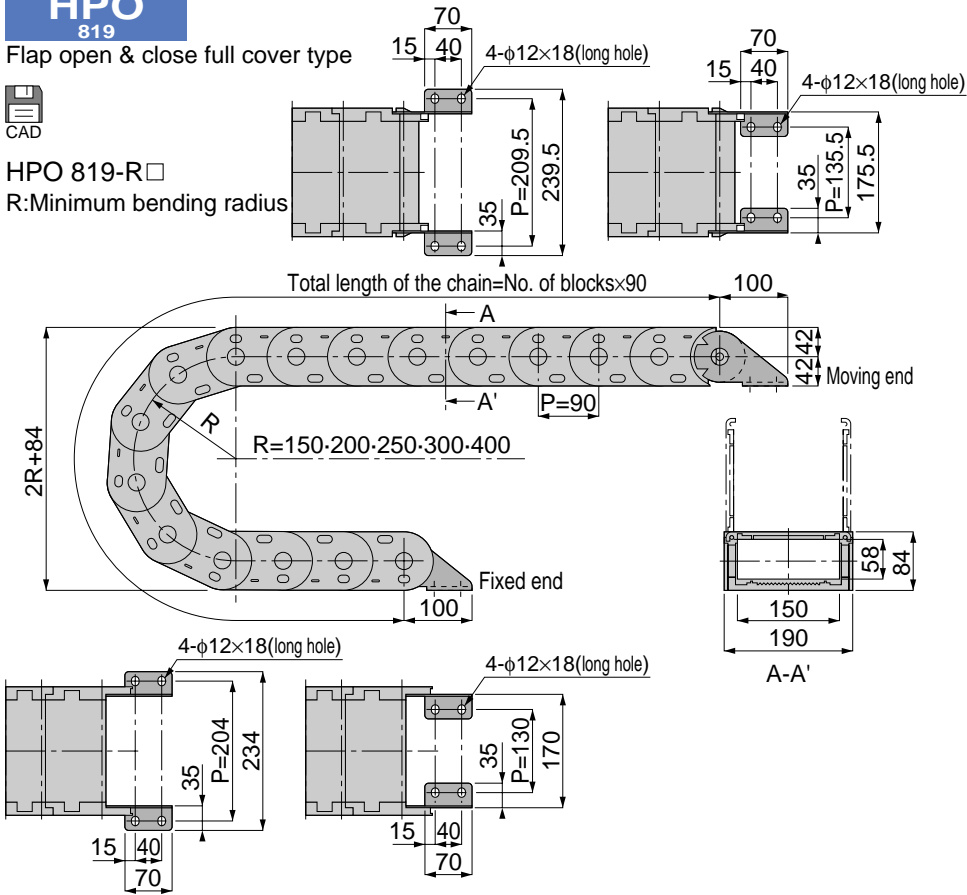

Diaphragm can be installed in HPO 819.

Diaphragm ordering code : SB-8

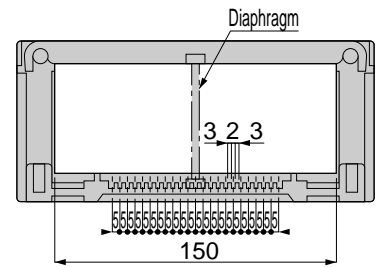

HPE 408-412

Separated Flap open & close type



HPE 408-R□

HPE 412-R□

R:Minimum bending radius

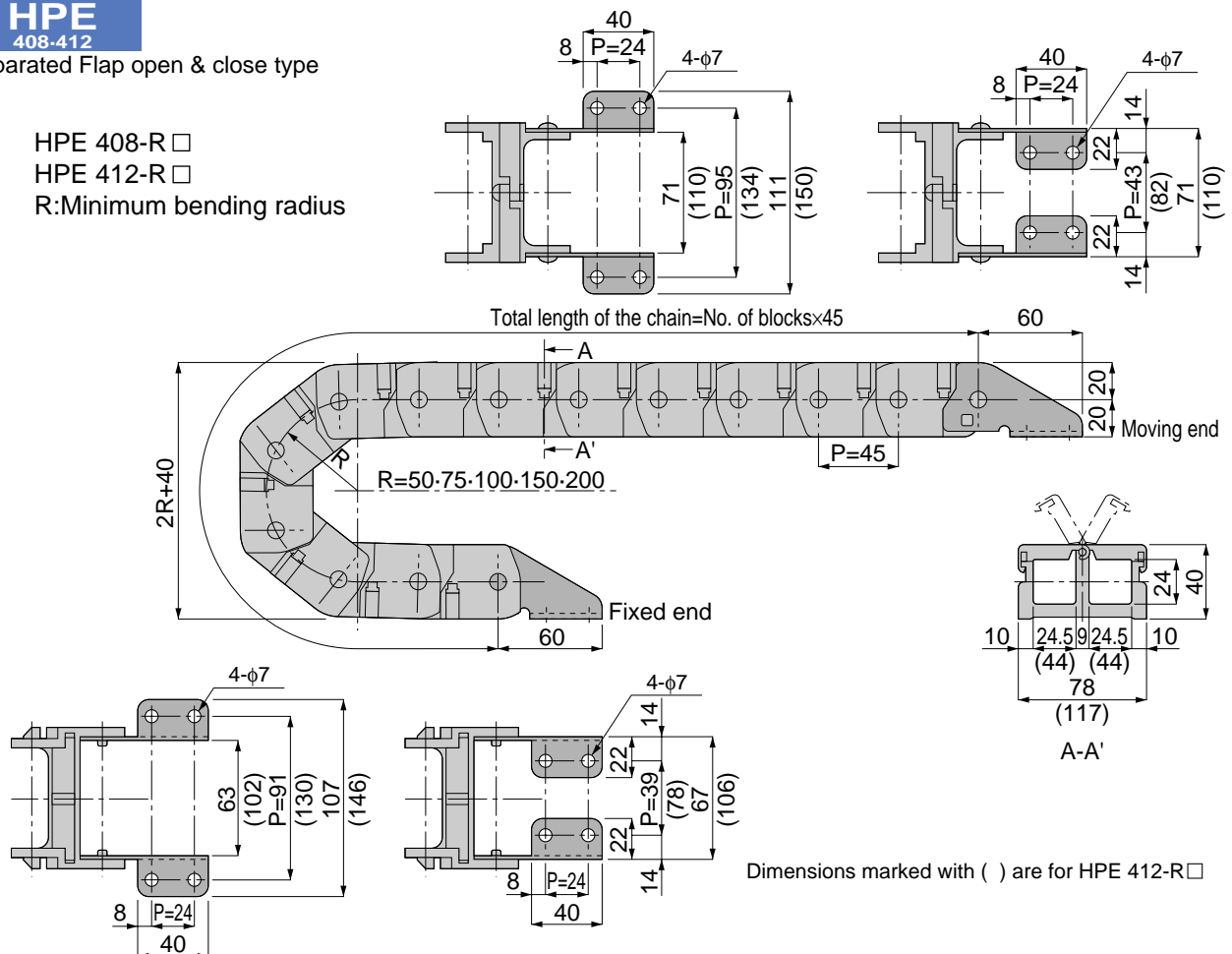

Dimensions marked with () are for HPE 412-R□

Plarailchains Series HP Series

HPK
101

Low-cost type

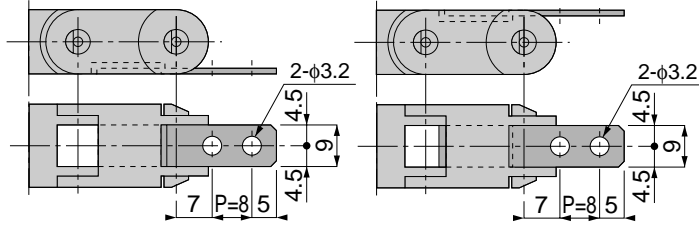

HPK 101-R □
R: Minimum bending radius

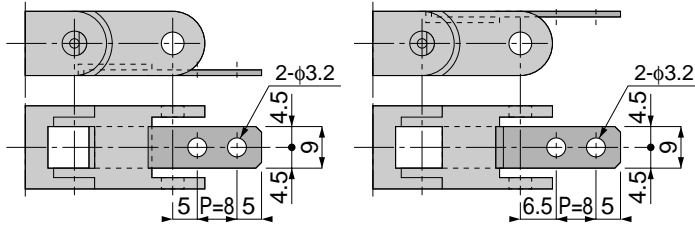
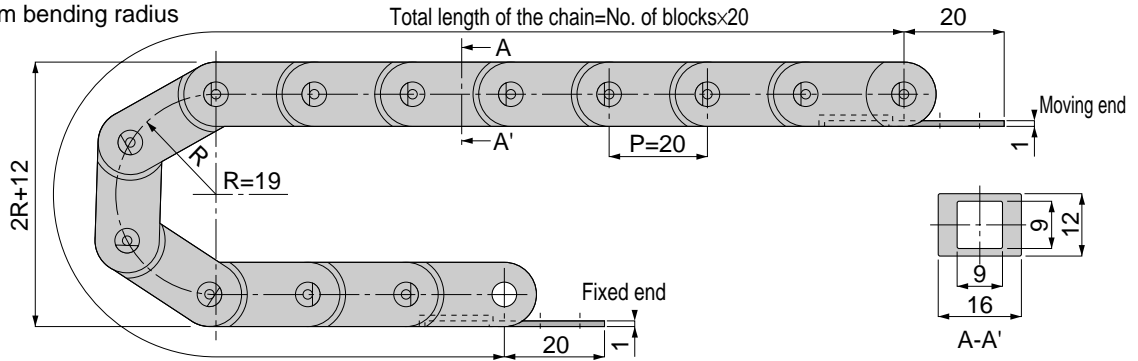

HPK
202-203

Low-cost type



HPK 202-R □
HPK 203-R □
R: Minimum bending radius

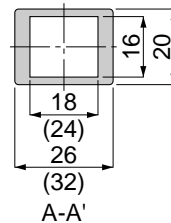
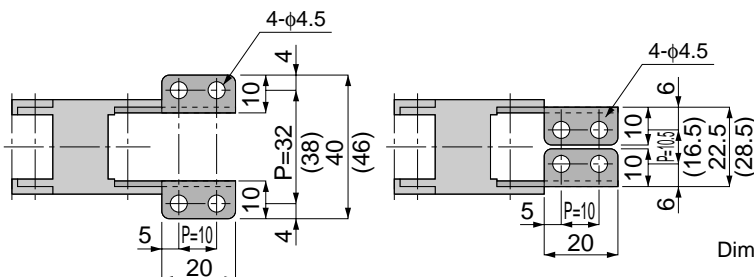
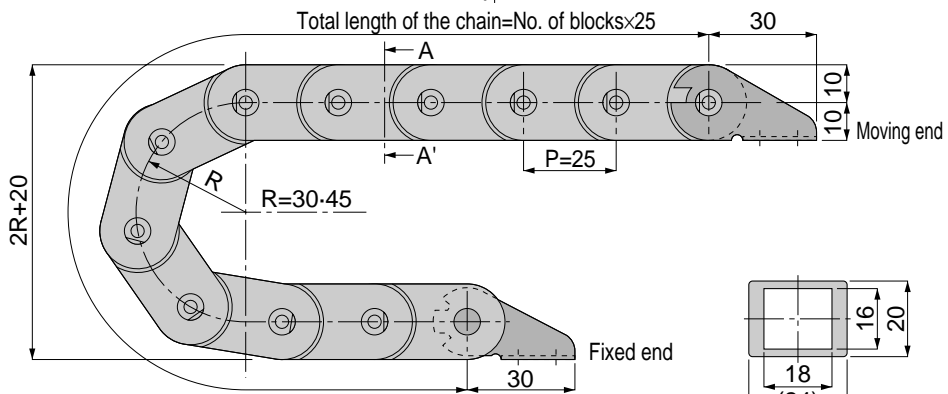
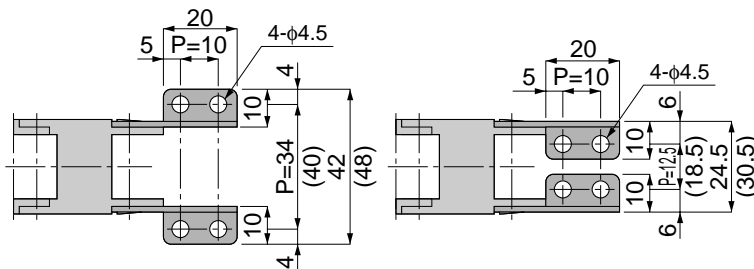

Dimensions marked with () are for HPK 203-R □



Low-cost type



HPK 204-R□
 HPK 206-R□
 R: Minimum bending radius

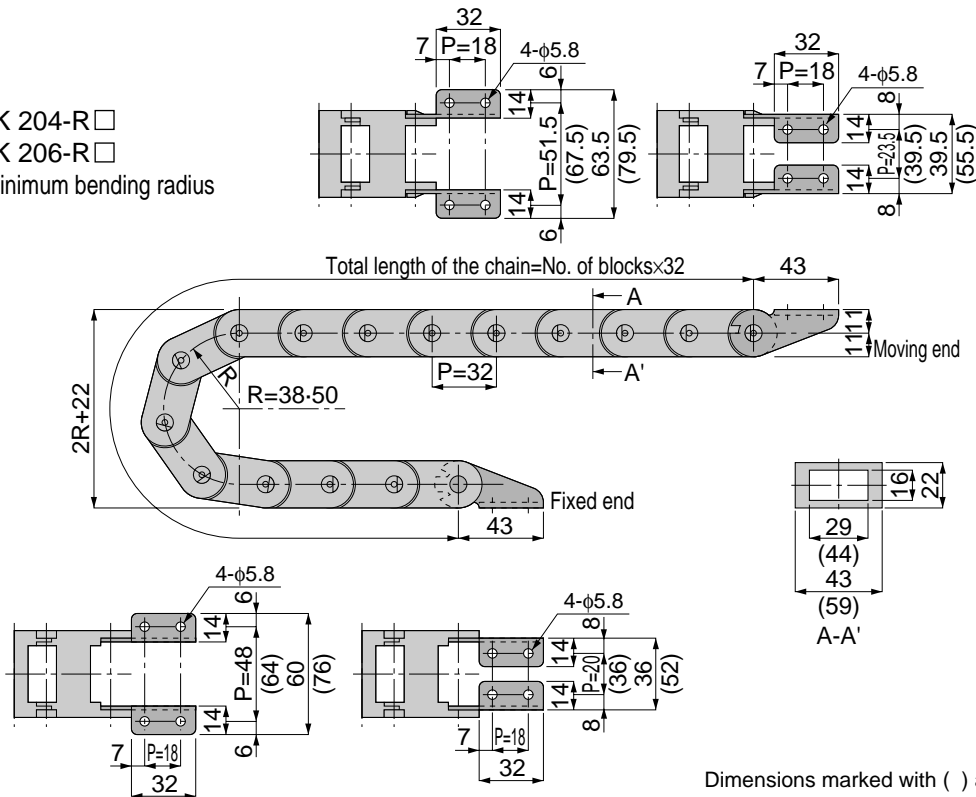

Dimensions marked with () are for HPK 206-R□

Plarailchains Series HP Series

HPM
204-205

Full cover type

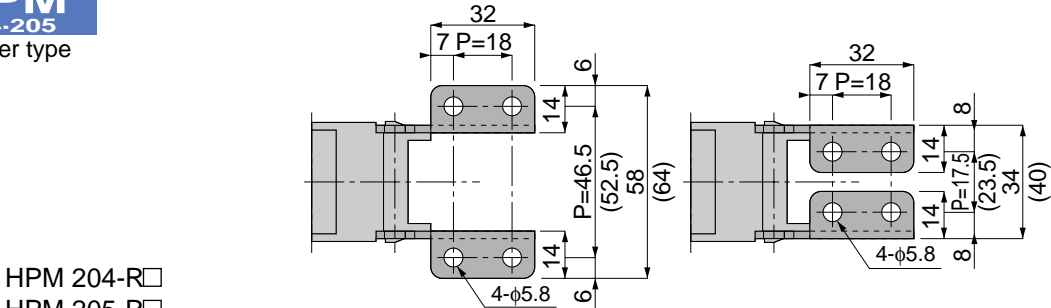

HPM 204-R□

HPM 205-R□

R: Minimum bending radius

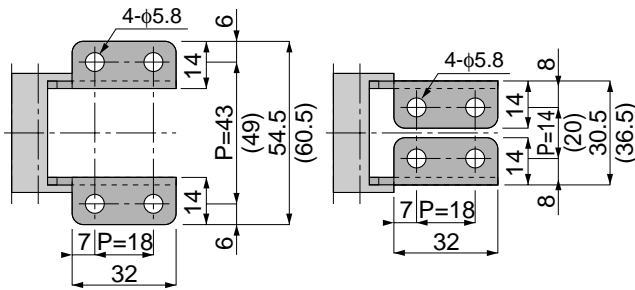
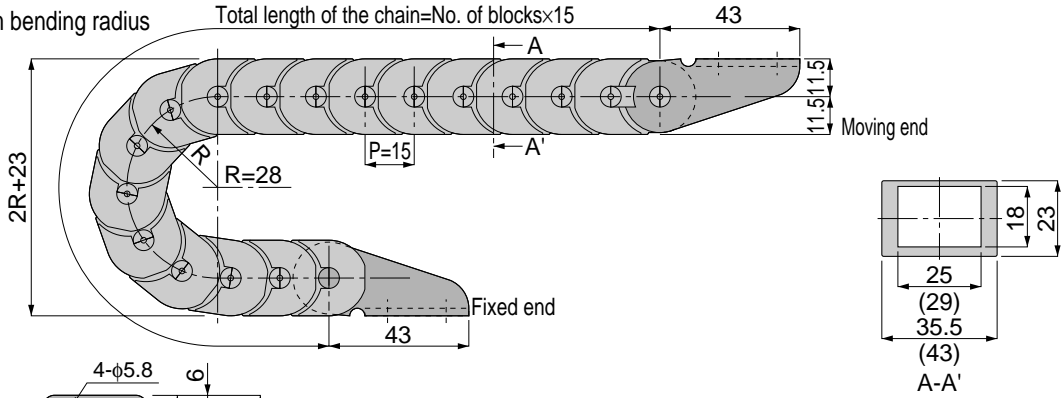

Dimensions marked with () are for HPM 205-R□

HPM
206

Full cover type



HPM 206-R□

R: Minimum bending radius

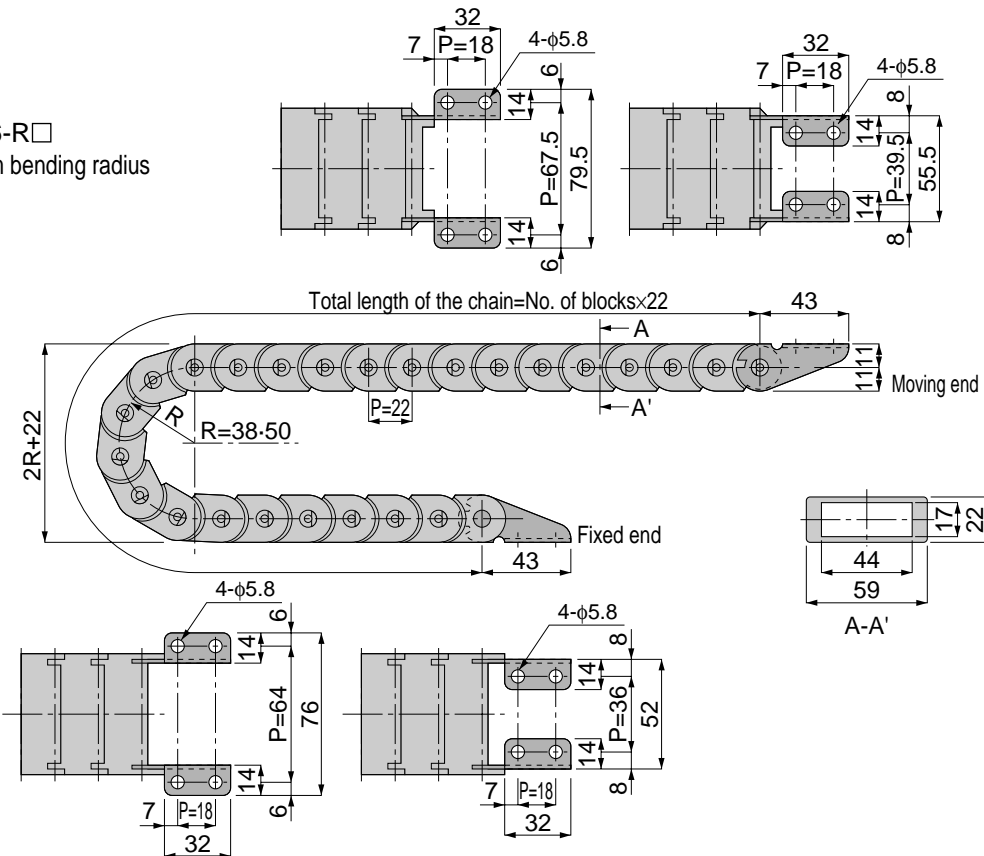

HPC
203

Center open & close type



HPC 203-R □
R: Minimum bending radius

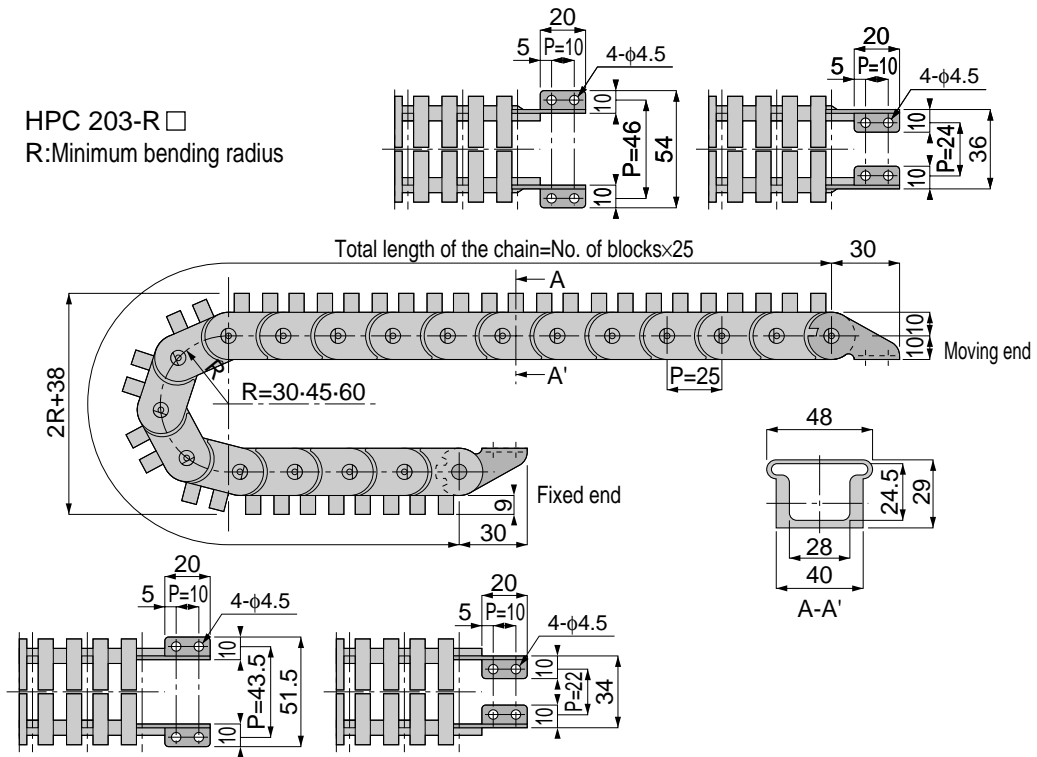

HPC
204

Center open & close type



HPC 204-R □
R: Minimum bending radius

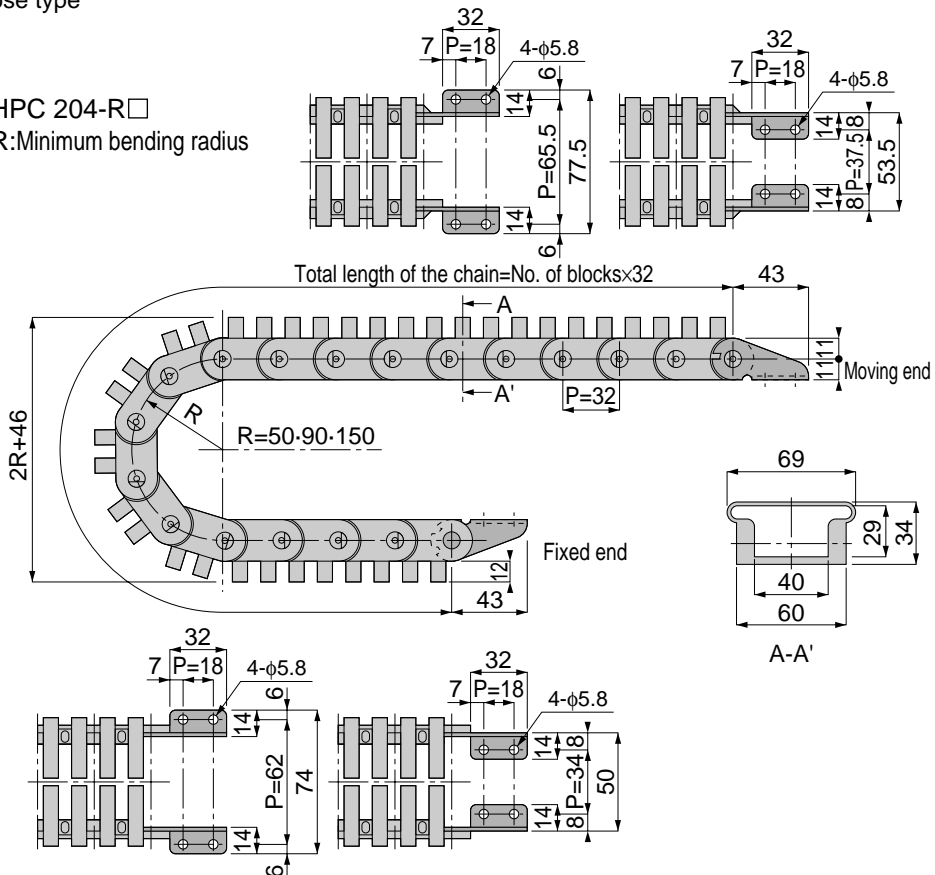

Plarailchains Series HP Series

HPC
306

Center open & close type



HPC 306-R□
R:Minimum bending radius

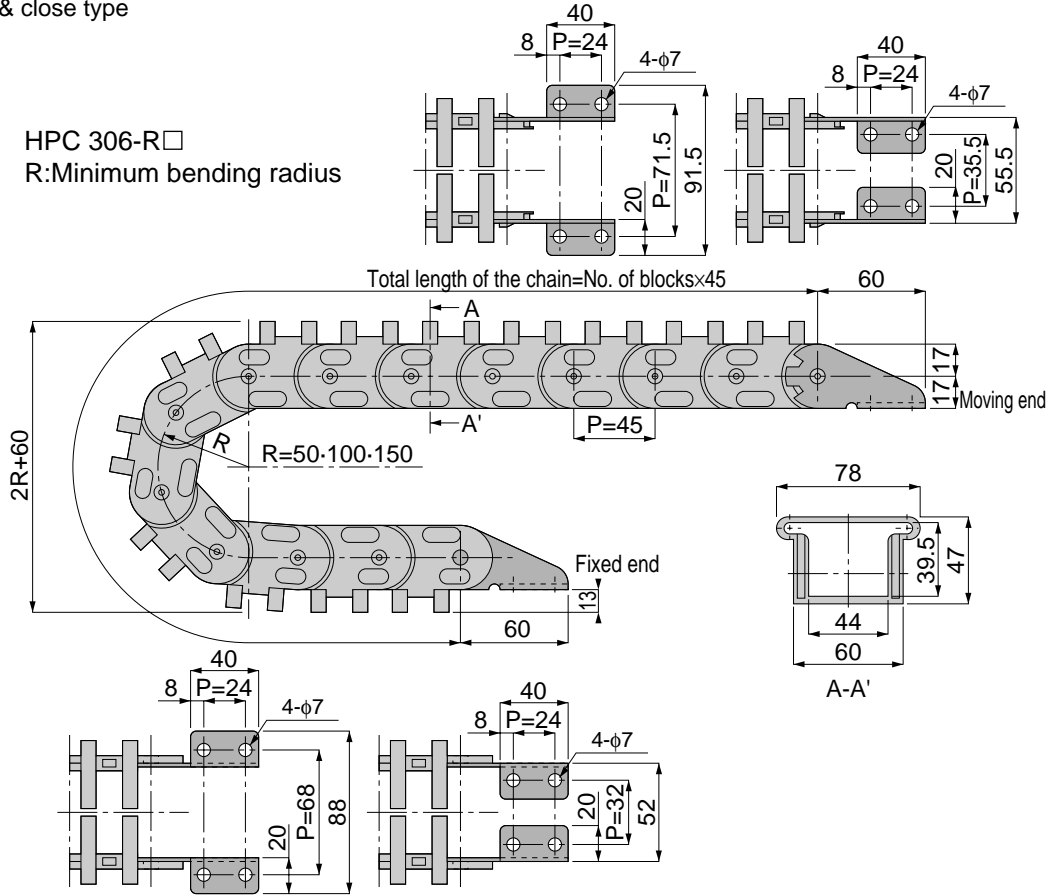

HPC
50-100-200

Center open & close type

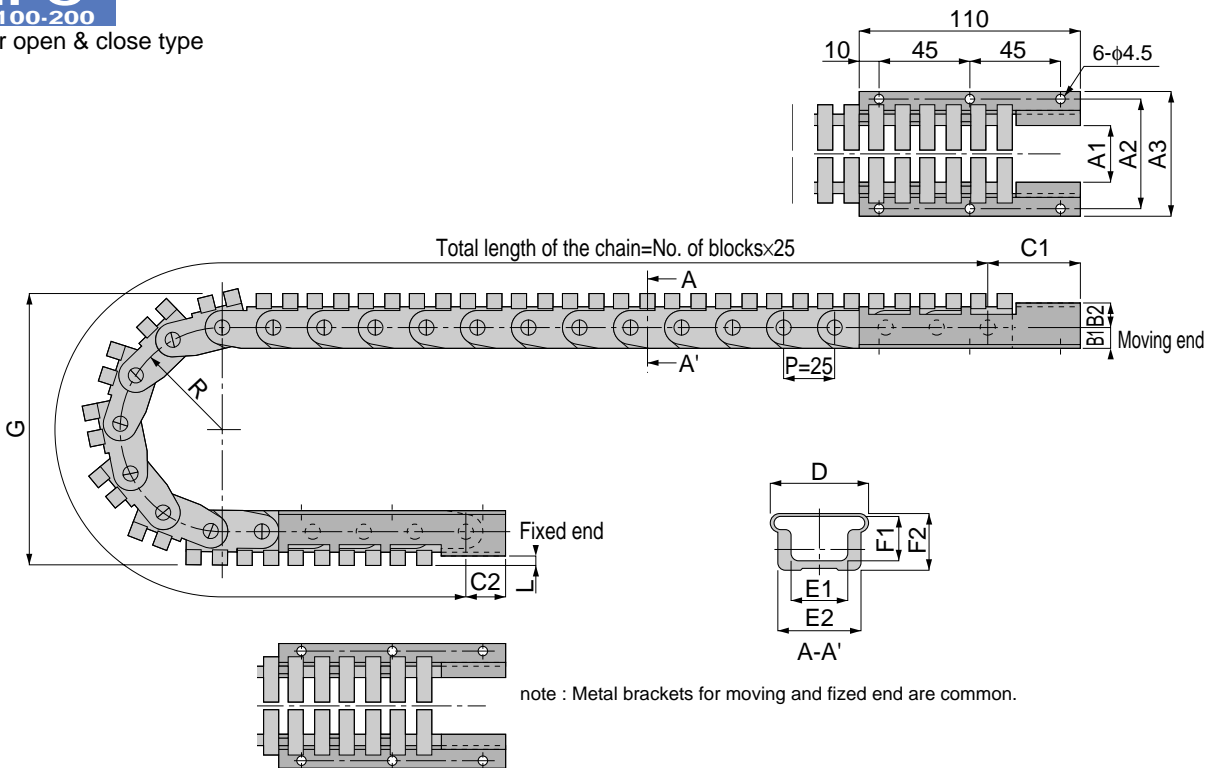

Unit : mm

Model	A1	A2	A3	B1	B2	C1	C2	D	E1	E2	F1	F2	G	L	R
HPC 50	30	52	60	10	10.5	45	21	48	28	40	20.5	26	152	6.5	60
HPC 100	45	67	75	13.5	14.5	42	22.5	69	40	55	30	37	227	9	90
HPC 200	60	82	90	18	16.5	41.5	23.5	84	54	70	35.5	44	260	9	105

Attachment/Detachment of the Metal Bracket

HPU
HPO
HPK
 (Except for HPK101)
HPE

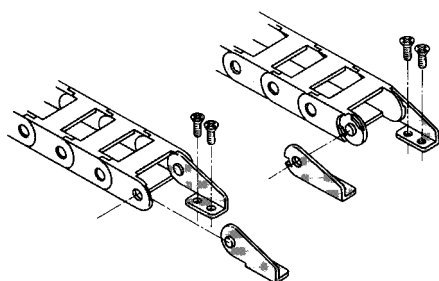

Metal bracket with a hole is attached to the moving end (with a pivot) of the body and metal bracket with a pivot is attached to the fixed end (with a hole), then they are fixed together by making use of the attachment hole for screwing.

HPU
 102

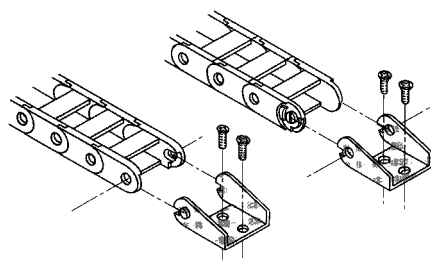

Metal bracket with a hole is attached to the fixed end (with a pivot) and metal brackets with a pivot is attached to the moving end (with a hole), of the body with opening the Flap.

HPK
 101

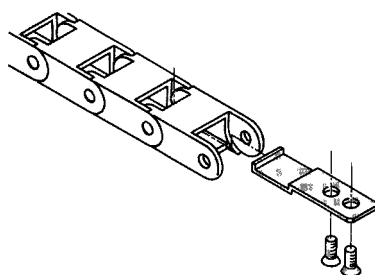

The metal bracket is fixed, in order to be hung on either upper or lower wall inside of the link. (The metal bracket can be used for both inner and outer peripheral attachment.)

HPC
 50

HPC
 100

HPC
 200

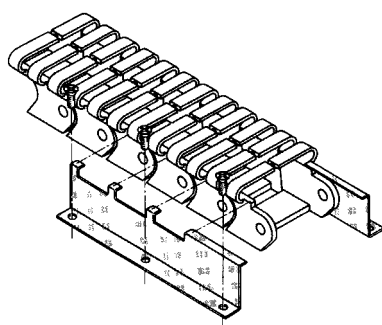

Protruded portion of the metal bracket is inserted in the gap between two flaps (covers) on outer side wall and is fixed with screws.

HPC
 203

HPC
 204

HPC
 306

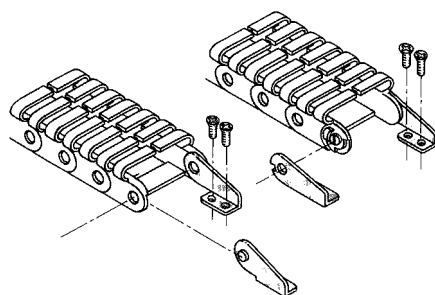

Metal bracket with a hole is attached to the moving end (with a pivot) of the body and metal bracket with a pivot is attached to the fixed end (with a hole), then they are fixed together by making use of the attachment hole for screwing.

Opening, closing, connection, separation

HPU, HPE Series

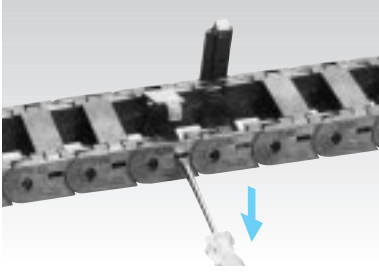

opening & closing

Insert square-bar screw driver to the slot on the side and press the flap open. The flap will close if it is pressed from the top.

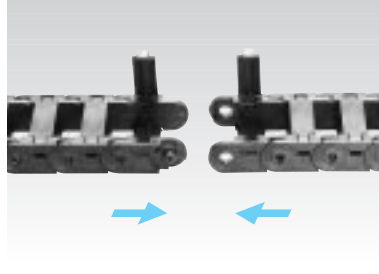

Connection

Open the flap of the links to be connected. Align the blocks and push from both side.

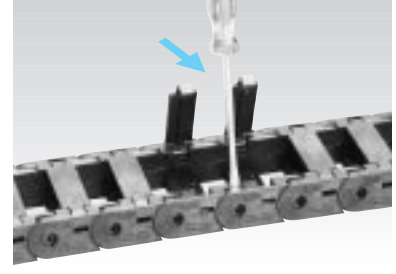

Separation

Open the flaps of the links to be separated. Insert square-bar screw driver to the space between the links. Tilt the screw driver and the links will be separated.

HPK, HPM Series

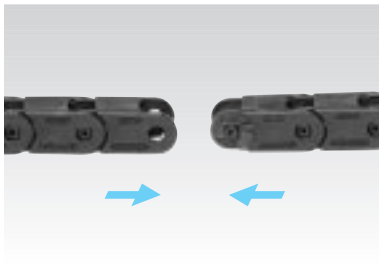

Connection

Align the links and push from both sides.

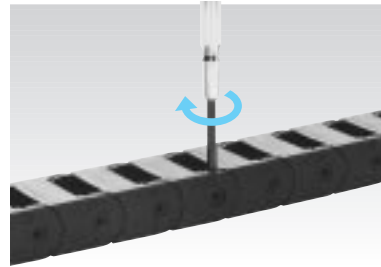

Separation

Insert square-bar screw driver into the space between links and turn.

HPO Series

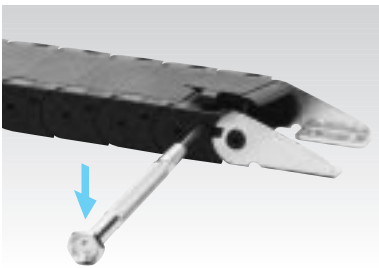

opening & closing

Insert square-bar screw driver to the slot on the side and tilt to open the flap.

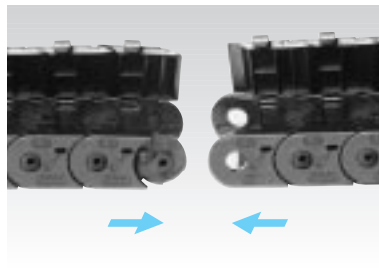

Connection

Open the flaps of the links to be connected. Align the links and push from both sides.

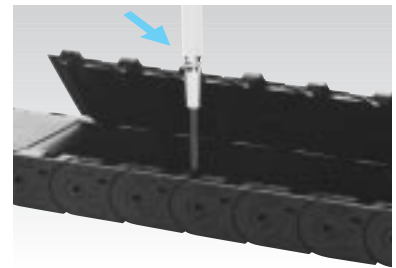

Separation

Open the flaps of the links to be separated. Insert square-bar screw driver into the space between links and tilt.

HPC Series

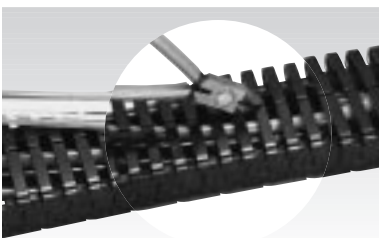

opening & closing

Install cable/hose after cutting through the center of flaps by a knife (nipper).

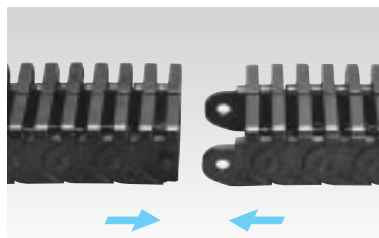

Connection

Align the links and push from both sides.

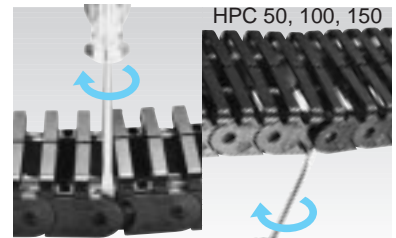

Separation

Insert square-bar screw driver into space between links and turn.

HPC 50, 100, 150
HPC 203, 204, 304

Metal Bracket for attachment

Select best-suited for your application from among a variety of bracket models. For moving end (the hole type) and the pivot type must be ordered separately when you need them both.

Note that some brackets come with the markings of product names and that the marking "-R" or "-L" after the product name has nothing to do with your designation code.

Use	for moving end				for fixed end			
Bracket type	  Hole type(for moving end)				  Pivot type(for fixed end)			
Screw position	 Inside		 Outside		 Inside		 Outside	
Orientation	 Outside	 Inside	 Outside	 Inside	 Outside	 Inside	 Outside	 Inside
HPU 102	U 1-K	U 1-K	—	—	*1	*1	—	—
HPU 202	U 2-MAOS	U 2-MAIS	U 2-MAOS	U 2-MAIS	U 2-FAOS	U 2-FAOS	U 2-FBOS	U 2-FBOS
HPU 203								
HPU 204								
HPU 206	U 2-MAO	U 2-MAI	U 2-MAO	U 2-MAI	U 2-FAO	U 2-FAO	U 2-FBO	U 2-FBO
HPU 306	U 3-MAO	U 3-MAO	U 3-MAO	U 3-MAO	U 3-FAO	U 3-FAI	U 3-FBO	U 3-FBI
HPU 408	U 4-MAO	U 4-MAO	U 4-MAO	U 4-MAO	U 4-FAO	U 4-FAI	U 4-FBO	U 4-FBI
HPU 412								
HPU 615	U 6-MAO	U 6-MAO	U 6-MAO	U 6-MAO	U 6-FAO	U 6-FAI	—	—
HPO 202	U 2-MAOS	U 2-MAIS	U 2-MAOS	U 2-MAIS	U 2-FAOS	U 2-FAOS	U 2-FBOS	U 2-FBOS
HPO 203								
HPO 204								
HPO 206	U 2-MAO	U 2-MAI	U 2-MAO	U 2-MAI	U 2-FAO	U 2-FAO	U 2-FBO	U 2-FBO
HPO 408	U 4-MAO	U 4-MAO	U 4-MAO	U 4-MAO	U 4-FAO	U 4-FAI	U 4-FBO	U 4-FBI
HPO 412								
HPO 512	U 5-MAO	U 5-MAO	U 5-MAO	U 5-MAO	U 5-FAO	U 5-FAO	U 5-FBO	U 5-FBO
HPO 819	U 8-MAO	U 8-MAO	U 8-MAO	U 8-MAO	U 8-FAO	U 8-FAO	U 8-FBO	U 8-FBO
HPK 101	K 101K	K 101K	—	—	*1	*1	—	—
HPK 202	U 2-MAOS	U 2-MAIS	U 2-MAOS	U 2-MAIS	U 2-FAOS	U 2-FAOS	U 2-FBOS	U 2-FBOS
HPK 203								
HPK 204								
HPK 206	U 2-MAO	U 2-MAI	U 2-MAO	U 2-MAI	U 2-FAO	U 2-FAO	U 2-FBO	U 2-FBO
HPC 203	U 2-MAOS	U 2-MAIS	U 2-MAOS	U 2-MAIS	U 2-FAOS	U 2-FAOS	U 2-FBOS	U 2-FBOS
HPC 204	U 2-MAO	U 2-MAI	U 2-MAO	U 2-MAI	U 2-FAO	U 2-FAO	U 2-FBO	U 2-FBO
HPC 306	U 3-MAO	U 3-MAO	U 3-MAO	U 3-MAO	U 3-FAO	U 3-FAI	U 3-FBO	U 3-FBI
HPC 50	—	—	—	HPC 50K *2	—	—	—	HPC 50K *2
HPC 100	—	—	—	HPC 100K *2	—	—	—	HPC 100K *2
HPC 200	—	—	—	HPC 200K *2	—	—	—	HPC 200K *2
HPE 408	E 4-MAO	E 4-MAI	E 4-MAO	E 4-MAI	E 4-FAO	E 4-FAO	E 4-FAO	E 4-FAO
HPE 412								
HPM 204	M 2-MAO	M 2-MAO	M 2-MAO	M 2-MAO	M 2-FAO	M 2-FAO	M 2-FBO	M 2-FBO
HPM 205								
HPM 206	U 2-MAO	U 2-MAI	U 2-MAO	U 2-MAI	U 2-FAO	U 2-FAO	U 2-FBO	U 2-FBO

*1.The brackets for HPU 102 and HPK 101 come in a set of moving-end and fixed-end brackets. They are different in shape from the illustrations in the above table. (See page 612.)

*2.The brackets for HPC 50, 100, and 200 are different in shape from the illustrations in the above table. (See page 612.)

New

Cable, Hose protection, Guiding device Plarailchains SP Series

Features

- Compared with conventional products, improved durability of cables, hoses, and components.
 - Special resins reduce wear and tear by one-fourth to one-fifth of conventional products.
- The Plarailchains' body has been improved for extended durability, and longer life.
 - Reinforced filler and composite materials are utilized with state-of-the-art designing.
- Less water absorption compared with conventional nylon-related materials, thus size transformation and hardness drop less occur.
- Greater sound arresting performance compared with conventional products.
- New materials allow for greater interior space while allowing the Plarailchains unit as a whole to be smaller.
- Brackets in one type only for each moving end use and fixed end use, simplifies ordering.
 - Choice from 16 different ways of attaching made possible by orientating same brackets.

Specifications

Item \ Model	1520	2550	2585	35105
Pitch(mm)	25	36	43.5	62.5
No. of links(/m)	40	28	23	16
Max. cable dia.(mm)	φ12	φ20	φ20	φ28
Free span(m)	Refer to the capacity chart.			
Max. stroke(m)	2.4	3.1	3.6	4.6
Max. cable mass(kg)	2.2	6.5	8	13
Max. speed(m/s)	3			
Plarailchain mass(kg)	0.36	0.86	1.05	1.96
Service conditions	Avoid acidic or basic atmosphere and hot water.			
Service temperature range(°C)	-10~+80			
Noise level(Compared with conventional PISCO model)	-8	-10	-3	
Water absorption(%)	1.3			
Chemical-proof	Refer to page 624.			

Individual Description

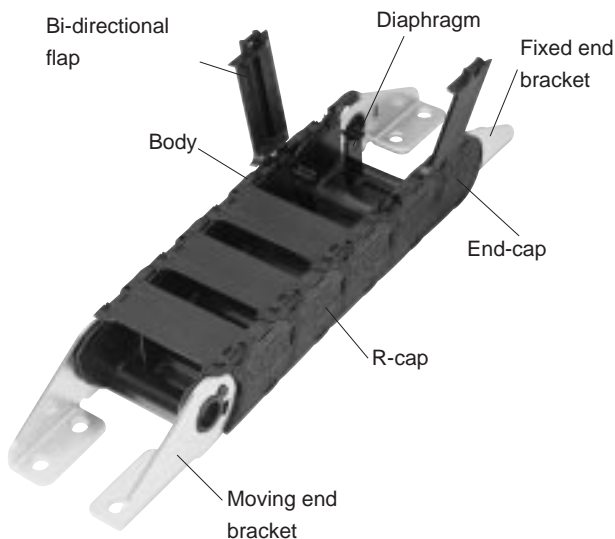

Capacity chart

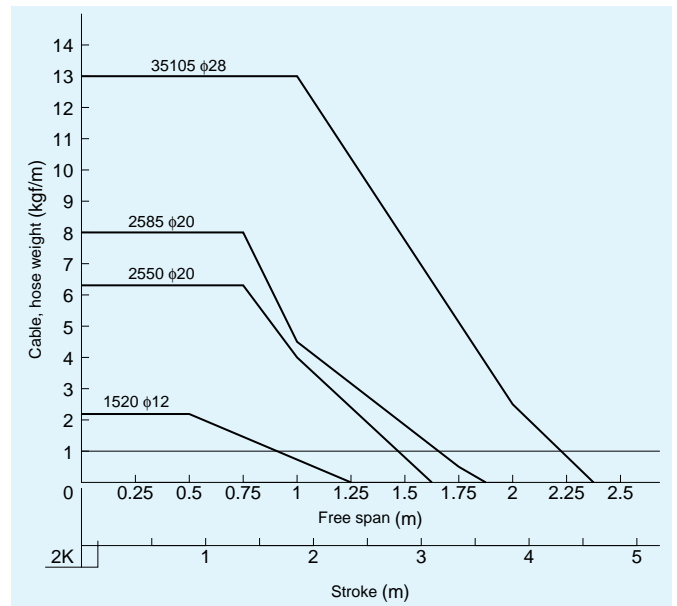

Calculation of number of links

Number of links is to be calculated by the following equation:

$$n = \frac{\frac{S}{2} + \pi R + 2K}{P}$$

n : Number of links

(Figures below decimal point are raised to one positive number)

S : Transfer stroke (mm)

R : Bending radius (mm)

K : Play (mm)

P : Pitch (mm)

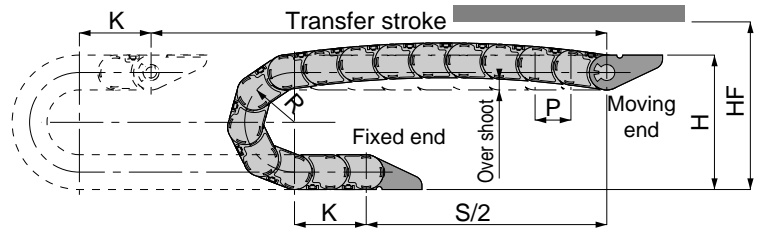

*HF in the above diagram is the clearance height in which overshoot of free span Parailchain without cable or hose inside it is taken into account.

Assembly measurement and weight chart

Model	R	H (mm)	HF (mm)	P (mm)	K (mm)	mass / link (g)
SP 1520	R 30	81	100	25	30 or more	9
	R 50	121	140			
	R 75	171	190			
SP 2550	R 50	135	160	36	50 or more	31
	R 75	185	210			
	R100	235	260			
SP 2585	R 60	155	180	43.5	50 or more	46
	R100	235	260			
	R150	335	360			
SP 35105	R 100	250	280	62.5	63 or more	123
	R 125	300	330			
	R 150	350	380			
	R 200	450	480			

Size

SP 1520

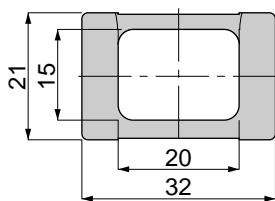

Bending radius	R30, R50, R75
link pitch(mm)	25
No. of links(/m)	40 links

SP 2550

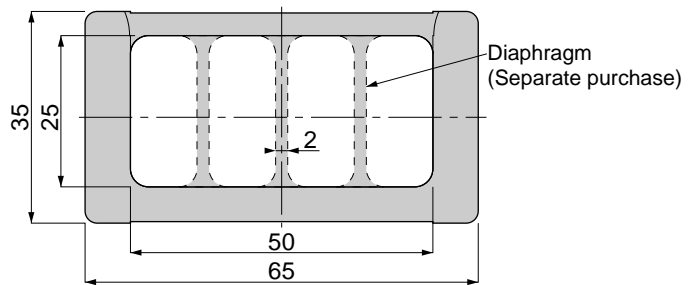

Bending radius	R50, R75, R100, R150
link pitch(mm)	36
No. of links(/m)	28 links

* A diaphragm may be attached in any position in addition to three other designated positions. Also, more than one diaphragm may be installed on any one link.

SP 2585

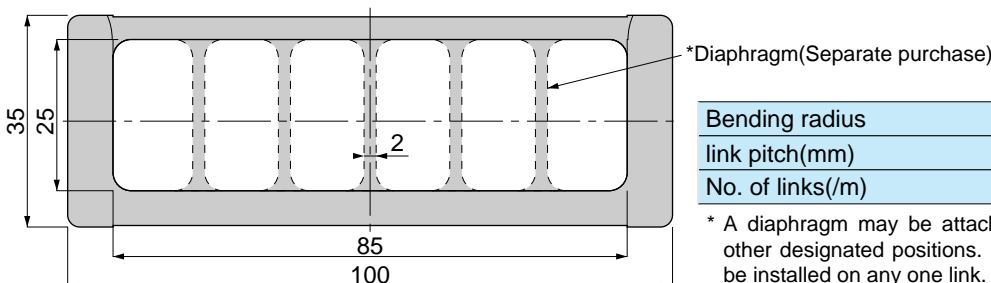

Bending radius	R60, R100, R150
link pitch(mm)	43.5
No. of links(/m)	23 links

* A diaphragm may be attached in any position in addition to five other designated positions. Also, more than one diaphragm may be installed on any one link.

Size

SP 35105

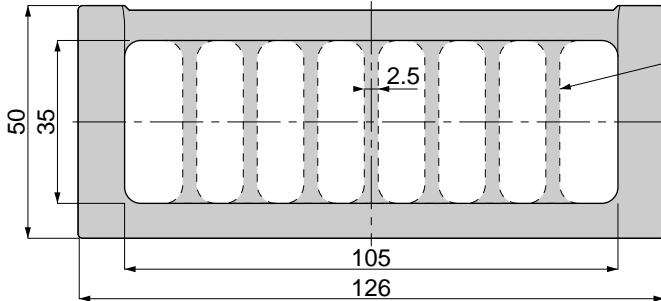

*Diaphragm(Separate purchase)

Bending radius	R100, R125, R150, R200
link pitch(mm)	62.5
No. of links(/m)	16 links

* A diaphragm may be attached in any position in addition to seven other designated positions. Also, more than one diaphragm may be installed on any one link.

Model Designation(Example)

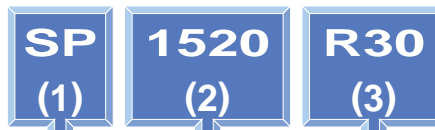

(1)Type

SP : SP Series

(2)Size(Inner dimensions·Height×Width)

Code	1520	2550	2585	35105
Size(mm)	15×20	25×50	25×85	35×105
Size(inch)	0.59×0.79	0.98×1.97	0.98×3.35	1.38×4.13

(3)Bending Radius

R	R30	R50	R60	R75	R100	R125	R150	R200
1520	○	○		○				
2550		○		○	○		○	
2585			○		○		○	
35105					○	○	○	○

Attachment Metal Bracket Model Designation(Example)

➔ Please refer to page 624 regarding Model Designation for Blackets.

⚠ Detailed Safety Instructions

Before using the PISCO device, be sure to read the "Safety Instructions", "Common Safety Instructions for Products Listed in This Manual" on page 23~24.

⚠ Warning

1. Never step on Plarailchain. Otherwise the chain may break and will fall down.
2. When connecting, disconnecting, opening, closing, or carrying out maintenance and checks, hold the Plarailchains motionless, otherwise the Plarailchain may run or fall under its own weight, thus doing injuries to you.
3. Pay attention to the flexing areas of the Plarailchains. You can get injured with your hand caught in the flexing area.
4. Before conducting maintenance or checks of Plarailchains, be sure to turn off power supply to the equipment for your safety.
5. The Plarailchains should only be used within stated specifications and conditions.
6. Never perform disassembly or remodeling that can affect the basic structure, performance or function of the equipment.
7. Tighten up all the brackets. Looseness of them can cause a breakdown of the whole system.
8. Do not apply unreasonable loads on metal fittings that may cause the Plarailchains to come out of place or be damaged. Loads that exceed specifications may lead to system failure.

⚠ Caution

1. Carefully read the "Hoses/Cable Installation" section in manual before use.
2. Examine the Plarailchains Performance Curve Chart in manual to select suitable type. Remember to test the Plarailchains before use since other factors may affect performance.
3. Cables and hoses to be stored must be flexible and wear-resistant, do not use wire-braided ones which are prone to damage.
4. For use under special circumstances, contact PISCO for guidance.

Plarailchains Series SP Series

SP 1520 TYPE

Flap open & close,
Low-wear, Low-noise type

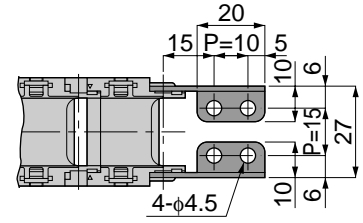
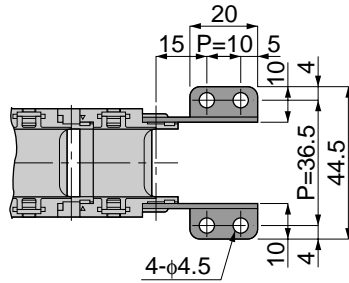

Total length of the chain=No. of blocks×25

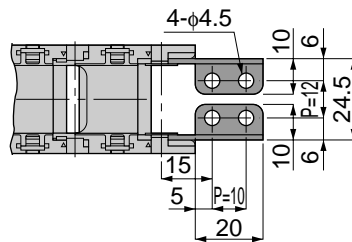
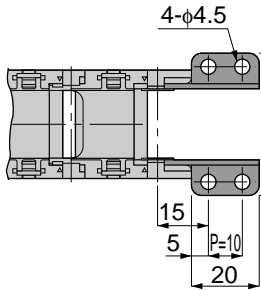
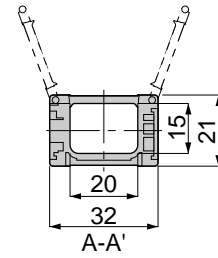
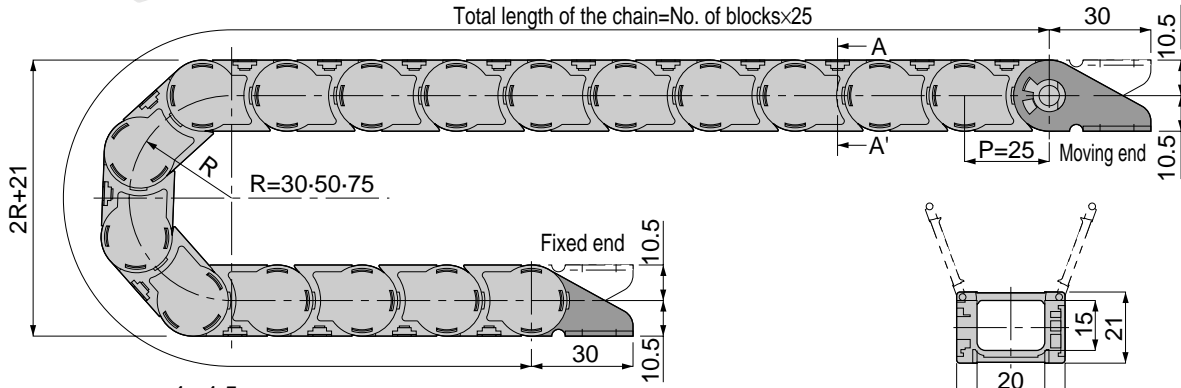

SP 2550 TYPE

Flap open & close,
Low-wear, Low-noise type

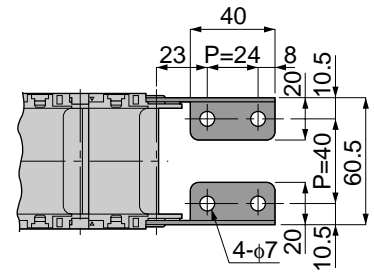
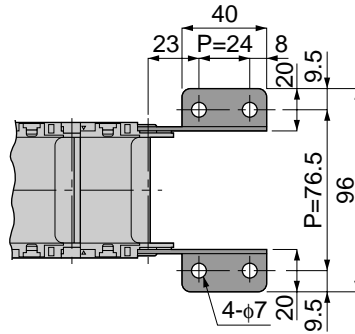

Total length of the chain=No. of blocks×36

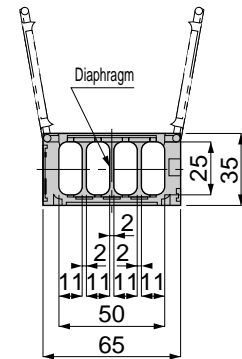
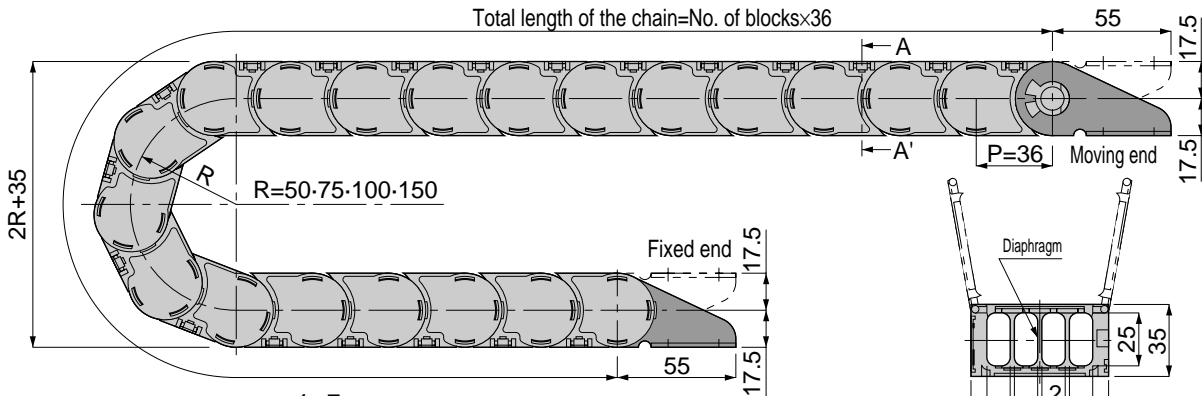

Diaphragm ordering code : SB-25

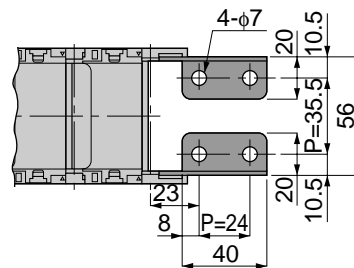
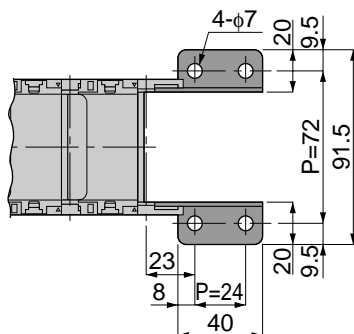

- Use of diaphragm
is recommended. -
Frictional loss is decreased.

SP

2585 TYPE

Flap open & close,
Low-wear, Low-noise type

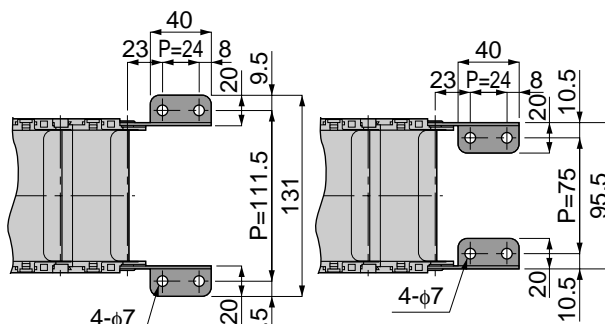

Total length of the chain=No. of blocks×43.5

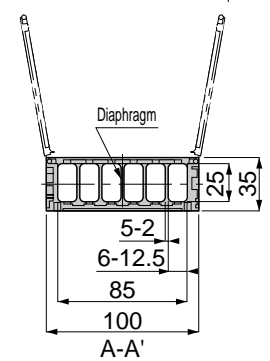
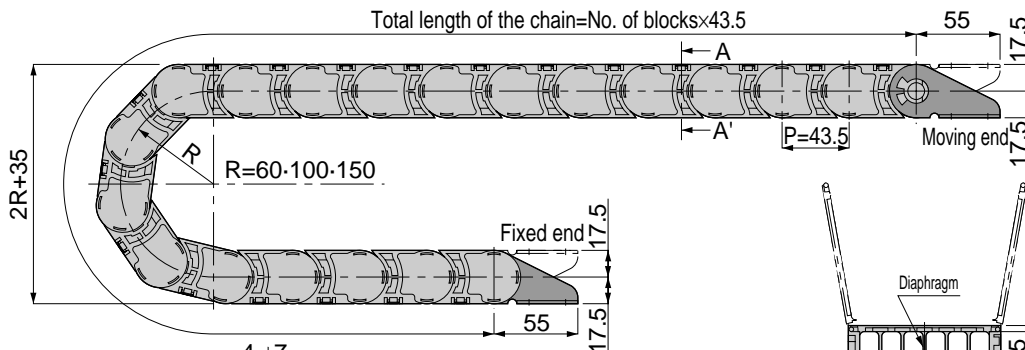

Diaphragm ordering code : SB-25

- Use of diaphragm is recommended. -
Frictional loss is decreased.

SP

35105 TYPE

Flap open & close,
Low-wear, Low-noise type

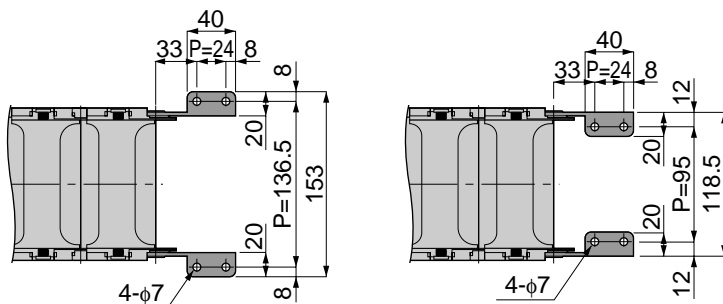

Total length of the chain=No. of blocks×62.5

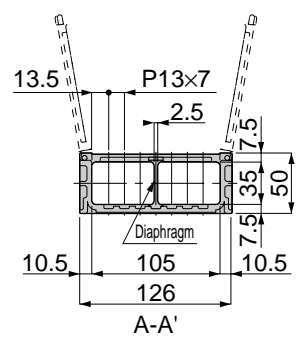
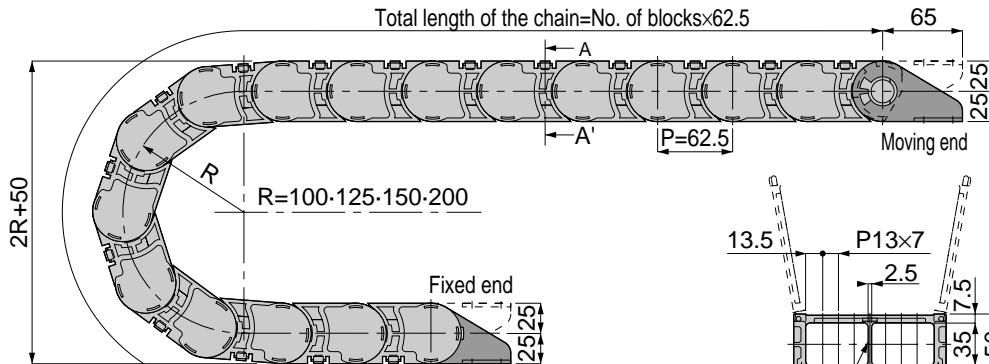

Diaphragm ordering code : SB-35

- Use of diaphragm is recommended. -
Frictional loss is decreased.

Plarailchains Series SP Series

Please read this instructions carefully for clear understanding of the correct use of this product.

⚠ Warning

When attaching/detaching caps, please pay attention not to injure your hands by a screwdriver.

1.Factory shipped configuration

1: The plastic rail chain (Plarailchains) and brackets are optional. Please order individually.

Plarail chains

Consisting of:

- Body(xNo. of links ordered)
- Flap(xNo. of links ordered)
- R-cap(xNo. of links ordered)

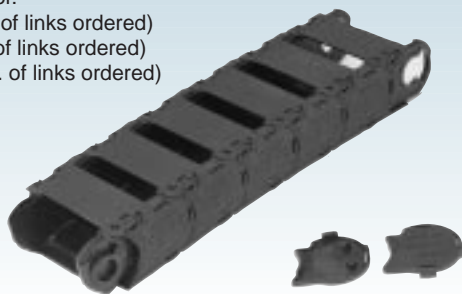

Bracket for moving end

Consisting of:

- Brackets for moving end



Bracket for fixed end

Consisting of:

- Brackets for fixed end
- End-cap



Diaphragm

Consisting of:

- Diaphragm(xNo. of items ordered)



2.Flap Opening/Closing

1: Open using a square-bar standard screw driver (See Fig. 1) and pull the flap up. To close, press flap down. (Opening/closing is possible from either side.)

Fig. 1

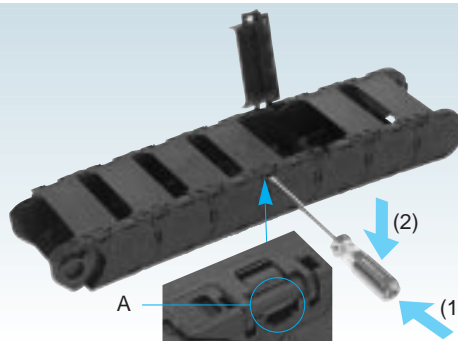

(Note) Tip width of square-bar standard screw driver:

- SP1520 : 2.5mm
- SP2585 : 3.0mm
- SP2550 : 3.0mm

2: To detach, lift the flap to a 45° angle and pull in the same. (Detaching may be done from either side.)

3.Bracket installation

1:Moving end brackets

(1)Set holes of metal fittings and boss on R-cap and join each other.

2:Fixed end brackets

(1)Embed End-cap coming with the fixed end brackets (SP□F) to body of Plarailchains (both side).

(2)Set the hole of brackets to the boss of End-cap and join them.(Attaching or detaching of cap should be referred to the "5. Attaching/Detaching of Cap.")

*The Plarailchains where the End-cap should be attached is not come with R-cap joined.

1 : Bracket for moving end (SP□M)

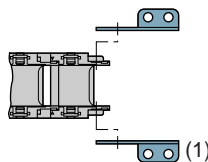

2 : Bracket for fixed end (SP□F)

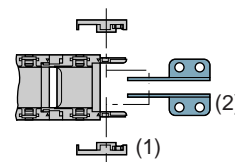

4. Increase/Decrease no. of links

Use Plarailchains with other than delivered length, make connection and disconnection refer to the following notice of procedure.

1: Increase no. of links

- (1) Open and remove flap of the each links to be connected.
- (2) Remove R-cap from one side of the link to be connected.
(Refer to "5. Attaching/Detaching of Cap.")
- (3) Start insert the boss and hole from the side of R-cap is removed, connect links by pressing from both ends.
(See Fig. 2)

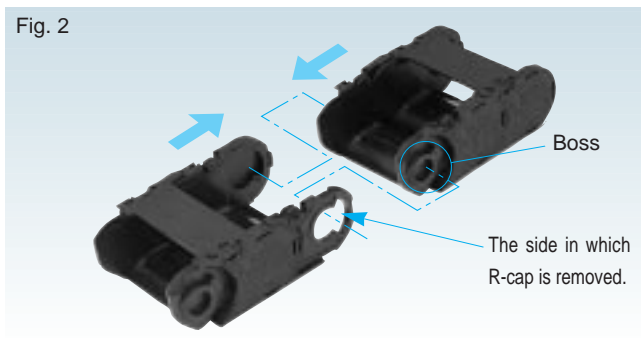

- (4) Taking care that the boss and hole are securely connected, reset removed R-cap (See Fig. 3/1) by applying continuous pressure until the three fixing claws are engaged with the grooves on the body.

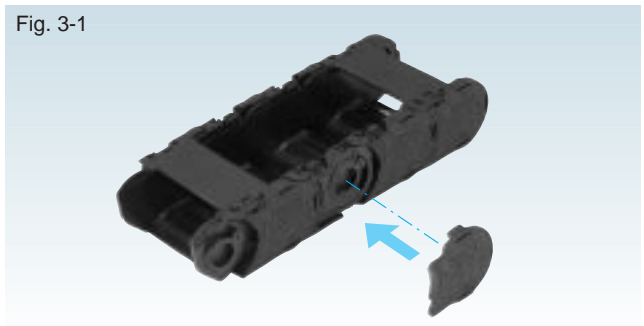

- (5) Apply continuous pressure to reset the flap (See Fig. 3-2) until the pin is engaged with the body's claw and the R shape faces in the direction of the boss.

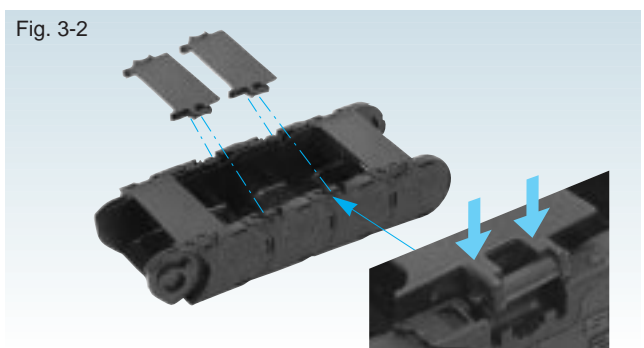

1: Decrease no. of links

- (1) Remove the flap from links to be disconnected. (See Fig. 4)
Using a square-bar standard screw driver, insert its tip into the gap (marked with a triangle) and press in the direction of the arrow to disconnect one side, then take whole apart. (It is not necessary to remove R-cap for disconnection.)

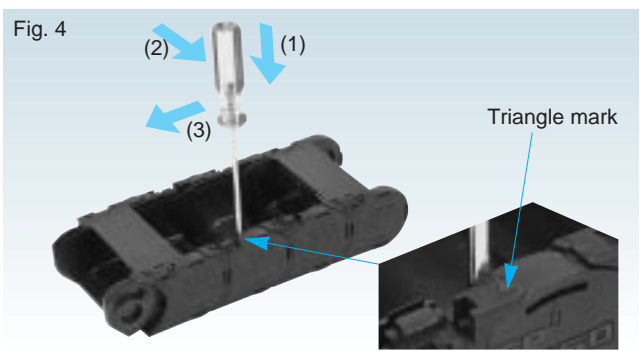

5. Attaching/Detaching Cap

When attaching and detaching R-cap or End-cap, use square-bar standard screw driver and insert its tip in the three B grooves (See Fig. 5-1). Following the example in Fig. 5-2, raise the claws while applying pressure on the claw's outer diameter as shown in Fig. 5-3. Pull the cap out from the body. Note: Removing caps before raising claws will damage unit.

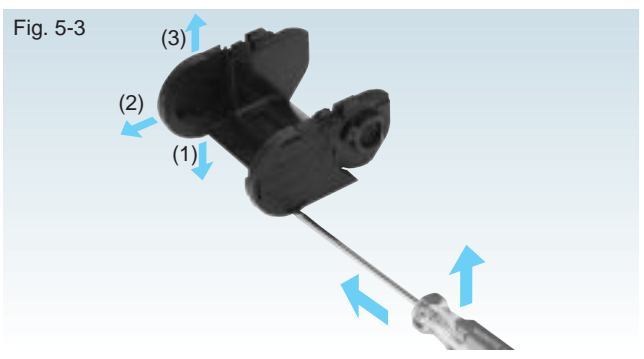
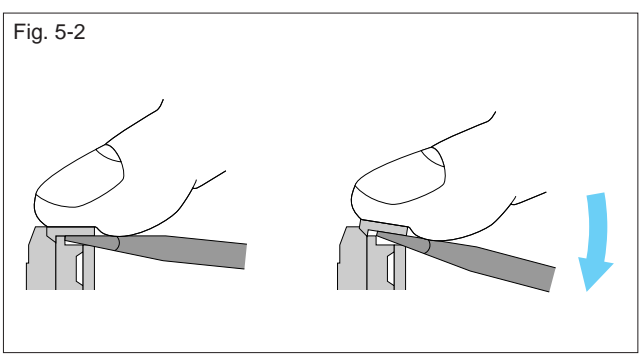
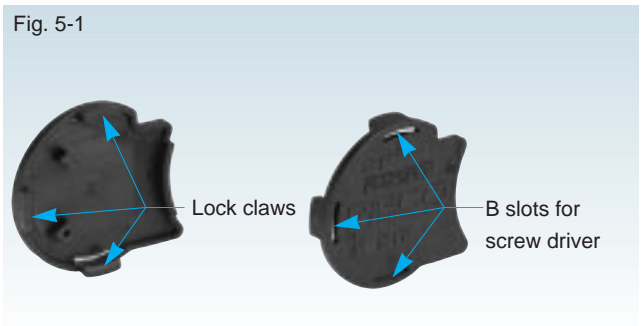

6. Diaphragm Installation

- 1: There are two methods for attaching a diaphragm according to intended use, (See Figs. 6-1 and 6-2). Use the first for fixed attaching. Hold the unit so that the letter "L" (on the diaphragm) faces right side up. Press the diaphragm into the groove. The second method is for variable diaphragm placement. Hold the unit so that the letter "L" faces the groove, then press the diaphragm into the groove.

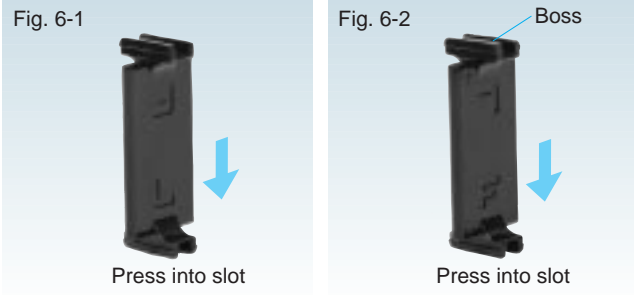

- 2: As indicated in Fig. 7-1, install diaphragms at an intervals of at least 1.1 times larger than cable/hose diameter (d). The interval for fixed installation of diaphragms is 11mm in SP2550 and 2585, 13mm in SP35105.

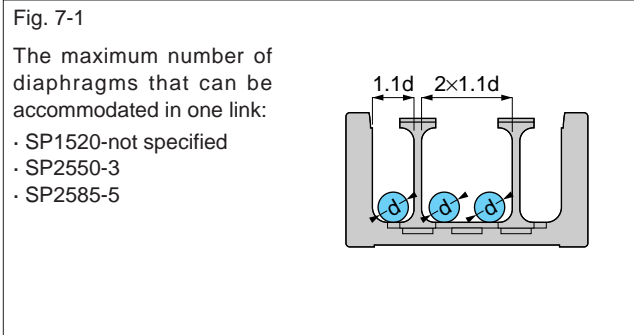

- 3: It is recommended that diaphragm(s) be installed in every other link as shown in Fig. 7-2. When more than one diaphragm is needed per link, do not arrange them side by side.

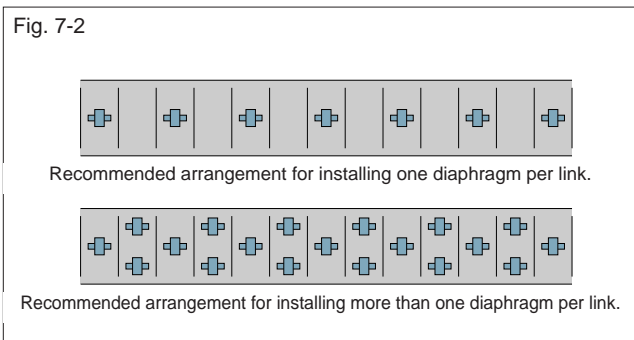

7. Hose/Cable Installation

- The total volume of contents (tube, hose or cable) to be fitted into Plarailchains should be arranged not to exceed 70% of its inside capacity of each model.
- Choose appropriate Plarailchains that maximum diameter of contents (tube, hose or cable) is to be 80% of its inside dimension.
- Contents should be lined up without crossing each other when they are stored into Plarailchains.
- Contents should be stored well-balanced in right and left in Plarailchains.
- In case of different contents such as air tubes, water tubes, cables, and/or etc. are stored into the same body, please select bending radius of Plarailchains according to the largest bending radius among the contents.
- Contents should be stored well-balanced in right, left, up, and down. Especially, different diameter of contents are stored into same body, choose the way of contents should be lined up without crossing in horizontal and vertical.
- The type with diaphragm, contents are stored in line separately with installing the diaphragm, thus effective measures to wear and scrap.
- To avoid excessive force and tension to Plarailchains, please fasten contents at the both ends of Plarailchains.

Brackets for SP Type Plarailchain

Brackets for the Plarailchains come in two types: moving end use and fixed end use. L and R are available as a set for each type. By combining brackets for both moving end use and fixed end use types, 16 different attaching options are available.

⚠ Brackets for moving end use and for fixed end use are not available as a set. If both types are needed, please order them separately.

⚠ End cap(plastic) enclosed with brackets for fixed end. Refer to section in this manual that describes use. When opening the end cap packing, be careful not to damage caps and handle with care.

Model Designation for Brackets

Body	Use			
	(M) Bracket for moving end	Mass(g)	(F) Bracket for fixed end	Mass(g)
SP1520	SP15M	136	SP15F	118
SP2550	SP25M	728	SP25F	678
SP2585				
SP35105	SP35M		SP35F	

Exterior/Outer-circumference Attaching

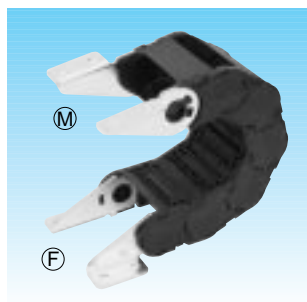

Exterior/Inner-circumference Attaching

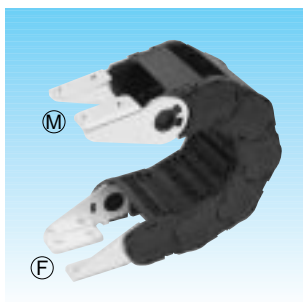

Interior/Outer-circumference Attaching

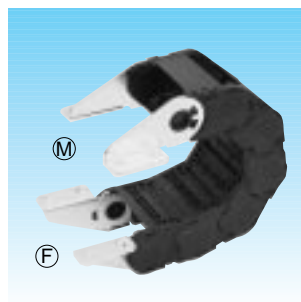

Interior/Inner-circumference Attaching

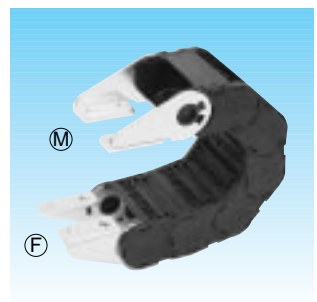

Chemical-proof properties

Classification	Chemical	Evaluation
Hydrocarbon	Benzene	◎
	Toluene	◎
	Xylene	◎
	Parafin	◎
Halogen hydrocarbon	Chloroform	○
	Carbon tetrachloride	◎
	Trichloroethane	◎
Oil	Gasoline	◎
	Mineral oil	◎
	Motor oil	◎
	Silicon oil	◎
Ether	Ethyl ether	◎
	Petroleum ether	◎
Alcohol	Methyl alcohol	○
	Ethyl alcohol	○
	IPA	○
	Butyl alcohol	◎
	Ethylene glycol	◎
Ketone/Aldehyde	Acetone	◎
	Methyl ethyl ketone	◎
	Formaldehyde	○

Classification	Chemical	Evaluation
Ester	Acetate	◎
Alkali Inorganic Salt	Sodium hydroxide(50%)	○
	Potassium hydroxide(50%)	○
	Aqueous ammonia(50%)	○
	Sodium chloride(saturated)	◎
	Sodium carbonate(10%)	◎
Phenol	Soap water	◎
	Phenol	×
Organic Acid	Resorcinol	×
	Formic acid(10%)	×
	Acetic acid(10%)	×
Inorganic Acid	Citric acid	○
	Hydrochloric acid(10%)	×
	Sulfuric acid(10%)	×
	Nitric acid(10%)	×
Metalic chloride	Chromic acid(10%)	×
	Zinc chloride	×
	Barium chloride	◎
	Calcium chloride	×

Room temperature test

Evaluation ◎ : No influence

○ : Slight influence

× : Considerable influence