

FRI SERIES

*Fixed Inline
Flow Control
Valves*



- Pressure Compensated

- Tamper proof settings
- 5000 psi (345 bar) working pressure
- Free reverse flow
- Flows to 30 gpm (115 l/min.)
- Five standard port sizes
- Rugged all-steel construction

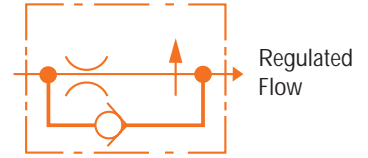

Features

These heavy duty, preset FRI Series valves provide an economical means of assuring accurate flow regulation to an actuator at a predetermined flow rate. Snap-tite preset Flow Control Valves maintain a tolerance of $\pm 10\%$. A minimum regulating pressure of 150 psi (10 bar) is required.

Snap-tite's Fixed Inline Flow Control Valves automatically compensate for changes in system pressure.

The free reverse flow feature allows immediate evacuation or reversal of the previous work at maximum speed with minimum pressure drop.

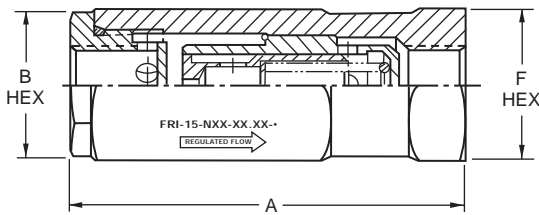

FRIA with Adjustment Stem Fully Closed and Fri

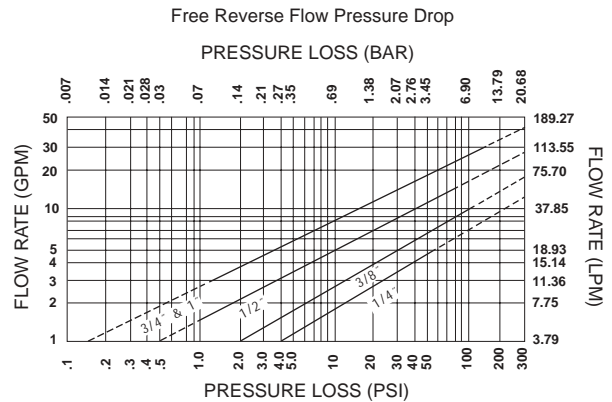

Dimensions and Specifications

Port Size (NPTF)	Flow Range (GPM)		A	B	F
1/4"	.75-5	In.	4.45	1.00	1.25
		mm	113.0	25.4	28.6
3/8"	1.0-10	In.	4.45	1.00	1.25
		mm	113.0	25.4	28.6
1/2"	1.5-15	In.	4.28	1.375	1.625
		mm	108.7	34.9	41.3
3/4"	3.0-30	In.	5.90	1.875	2.25
		mm	149.9	47.6	57.15
1"	3.0-30	In.	5.90	1.875	2.25
		mm	149.9	47.6	57.15

Available GPM Flow Rates by Size*

1/4"	3/8"	1/2"	3/4" - 1"
0.75	1.00	1.50	3.00
0.90	1.20	3.00	4.00
1.00	1.50	3.50	6.00
1.25	2.00	4.00	8.00
1.30	2.25	4.00	10.00
1.50	2.50	4.50	12.00
1.75	3.00	5.00	14.00
2.00	3.25	5.50	16.00
2.50	3.50	6.00	18.00
2.80	4.00	7.00	20.00
3.00	5.00	7.50	22.00
3.50	6.00	8.50	24.00
4.00	6.25	9.00	26.00
5.00	7.00	10.00	
	8.00	11.00	
	9.00	12.00	
	10.00	13.00	
		14.00	
		15.00	

FLOW RATES GIVEN IN U.S. GALLONS

*Other flow rates available. Consult factory.

FRIA SERIES

Adjustable
Inline Flow
Control
Valves

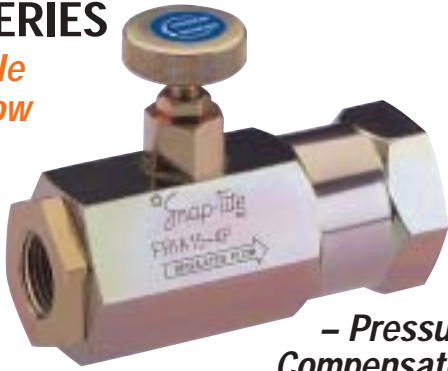

- Pressure
Compensated

- 5000 psi (345 bar) working pressure
- Flows to 30 gpm (115 l/min)
- Free reverse flow
- Five standard port sizes
- Fingertip adjustment & locking
- Rugged all steel construction
- Stainless steel adjustment assembly available

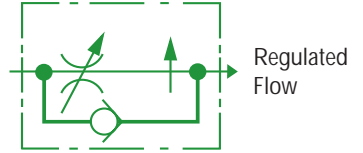

Features

Snap-tite's FRIA Series valves provide accurate, consistent control of hydraulic motor and cylinder actuation speeds and automatically compensate for changes in system pressure. Flow rate selection is infinitely variable within the extremes of the flow range for each size and can be adjusted under pressure. Snap-tite's Adjustable Flow Control Valves maintain a tolerance of $\pm 10\%$. A minimum regulating pressure of 150 psi (10 bar) is required.

The free reverse flow feature allows maximum return flow with minimum pressure loss. A locking nut assures positive setting against high vibration conditions.

FRIA with Adjustment Stem Fully Open

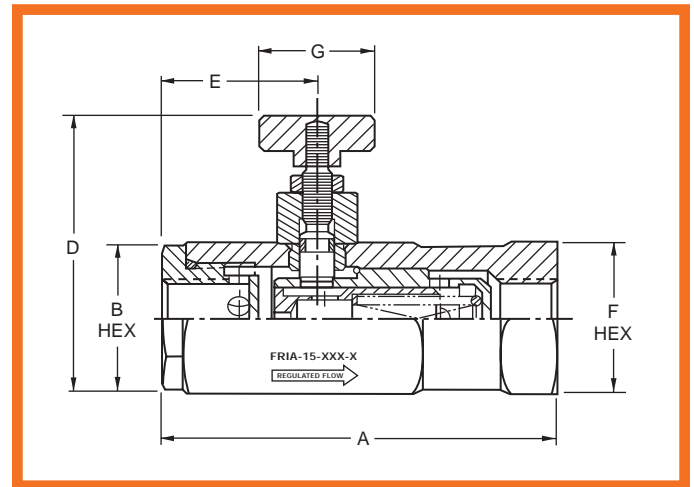
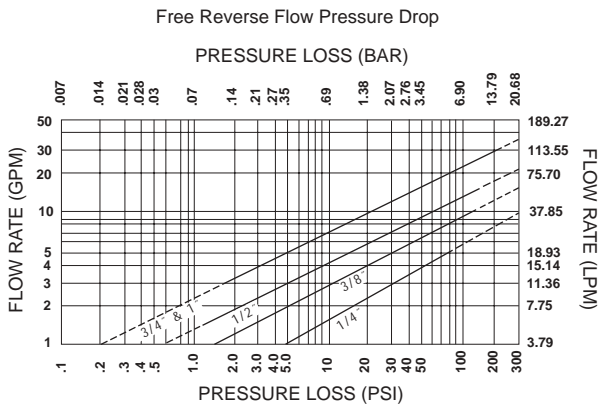

Flow curves are nominal and recorded with 100 ssu fluid.

Flow Regulation (80% Rated Flow)

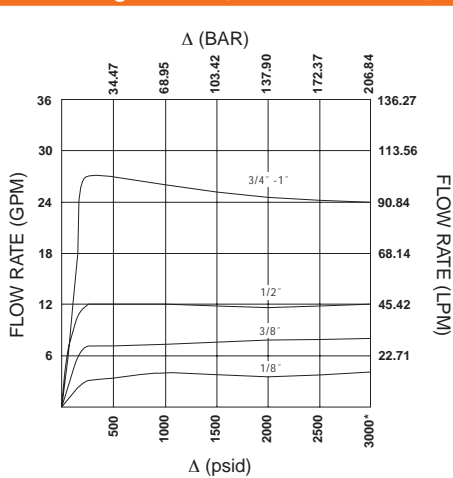

*3000 psi inlet pressure

Dimensions and Specifications

Port Size (NPTF)	Adjust. Range (GPM)		A	B	D	E	F	G
1/4"	.75-5	In.	4.45	1.000	2.56	1.94	1.125	1.00
		mm	113.0	25.4	65.0	49.3	28.6	25.4
3/8"	1.0-10	In.	4.45	1.000	2.56	1.94	1.125	1.00
		mm	113.0	25.4	65.0	49.3	28.6	25.4
1/2"	1.5-15	In.	4.28	1.375	3.25	1.65	1.625	1.25
		mm	108.7	34.9	133.5	41.9	41.3	31.8
3/4"	3.0-30	In.	5.90	1.875	3.75	2.22	2.25	1.25
		mm	149.9	47.6	95.3	56.4	57.15	31.8
1"	3.0-30	In.	5.90	1.875	3.75	2.22	2.25	1.25
		mm	149.9	47.6	95.3	56.4	57.15	31.8

ORDERING INFORMATION

Fixed Inline Flow Control Valves

FRI 05 - 2 P - 2.5 A

Series	Max. Flow Rating	Port Size		Port Thread Type	Required Flow <i>(info on pg. 2)</i>	Seal
		<i>NPTF or RP</i>	<i>SAE</i>		<i>GPM</i>	
Fixed Flow	05 - 5 gpm (20 l/min.)	2 - 1/4"	4 - 1/4"	P - NPTF		No-Letter-Viton (std.)
Regulator	10 - 10 gpm (40 l/min.)	3 - 3/8"	6 - 3/8"	S - SAE		
Inline	15 - 15 gpm (55 l/min.)	4 - 1/2"	8 - 1/2"	RP - Female		A - Buna
	30 - 30 gpm (115 l/min.)	6 - 3/4"	12 - 3/4"	British Parallel		
		8 - 1"	16 - 1"	BS2779		

Adjustable Inline Flow Control Valves

FRIA 05 - 2 P A

Series	Max. Flow Rating	Port Size		Port Thread Type	Seal
		<i>NPTF or RP</i>	<i>SAE</i>		
Flow	05 - 5 gpm (20 l/min.)	2 - 1/4"	4 - 1/4"	P - NPTF	No-Letter-Viton (std.)
Regulator	10 - 10 gpm (40 l/min.)	3 - 3/8"	6 - 3/8"	S - SAE	
Inline	15 - 15 gpm (55 l/min.)	4 - 1/2"	8 - 1/2"	RP - Female	A - Buna
Adjustable	30 - 30 gpm (115 l/min.)	6 - 3/4"	12 - 3/4"	British Parallel	
		8 - 1"	16 - 1"	BS2779	

! WARNING !

FAILURE OR IMPROPER SELECTION OR IMPROPER USE OF THE PRODUCTS AND/OR SYSTEMS DESCRIBED HEREIN OR RELATED ITEMS CAN CAUSE DEATH, PERSONAL INJURY AND PROPERTY DAMAGE.

This document and other information from Snap-tite, Inc., its subsidiaries and authorized distributors provide product and/or system options for further investigation by users having technical expertise. It is important that you analyze all aspects of your application and review the information concerning the product or system in the current product catalog. Due to the variety of operation conditions and applications for these products or systems, the user, through its own analysis and testing, is solely responsible for making the final selection of the products and systems and assuring that all performance, safety and warning requirements of the application are met.

The products described herein, including without limitation, product features, specifications, designs, availability and pricing, are subject to change by Snap-tite, Inc. and its subsidiaries at any time without notice.

Distributed by:



Quick Disconnect & Valve Division
 201 Titusville Road
 Union City, Pennsylvania 16438-8699 USA
 PH: 814-438-3821 FAX: 814-438-3069
 e-mail: qd&v_sales@snap-tite.com
www.snap-tite.com



Industrial Estate
 Whitemill - Wexford
 Republic of Ireland
 PH: 353-53-41566 FAX: 353-53-41582
 e-mail: ste_sales@snap-tite.com
www.snap-tite.com